



PRICE LIST

Effective Date: March 1, 2016

Casegoods

This document includes the 2.9% price increase adjustment effective April 1, 2017. Please visit www.IndianaFurniture.com for all the latest introductions.

Clearly Green

level®, BIFMA's sustainability certification program for furniture, is a comprehensive and transparent third-party certification program. The level mark attests that the product, the manufacturing facility, and the company responsible for the product brand, have been evaluated against the multi-attribute criteria of the ANSI/BIFMA e3 Furniture Sustainability Standard. Products certified under the level program can be chosen with confidence. All Indiana Furniture case-goods and seating solutions are BIFMA level® 2 Certified.



A number of Indiana Furniture products have achieved Intertek's ETL Environmental VOC Certification and are recognized as products that safeguard indoor air quality. The certification — which extends to Elevate, Gesso, Revolutions, Madera, Resilience, Canvas, all Conference, Reception and Seating solutions, demonstrates that Indiana Furniture's products conform to the ANSI/BIFMA Furniture Emissions Standards (M7.1/X7.1-2011) for Office Furniture Systems and Components. They also earn points for LEED Credit 4.5.



Once cured by UV lighting, our UVAdvantage® finish does not emit irritable toxins, formaldehyde, or solvents into the air creating safe work environments within new furniture installations. This has allowed us to earn Indoor Air Quality Certification on our products with UVAdvantage finish. Our UVAdvantage finish process greatly reduces hazardous air pollutants which contribute to smog formation. Excess UV finish is recaptured over and over again reducing waste material within our facilities.



Forest Stewardship Council® (FSC®) Chain-of-Custody(CoC) Certification is an assurance that wood based materials used in products come from forests that meet stringent environmental, social, and economic standards. It is the path taken by raw materials from the forest to the consumer, including all successive stages of harvesting, processing, manufacturing and distribution. Only products from FSC CoC companies can claim the FSC designation, assurance of a socially and environmentally responsible purchasing decision. FSC CoC Certification is recognized by the U.S. Green Building Council's (USGBC) LEED Rating System for environmentally focused design. From a customer perspective, the FSC label represents a promise made; CoC standards are the mechanism FSC uses to ensure that promise is delivered. Indiana Furniture has been awarded FSC CoC Certification, by GFA Certification GmbH, an independent third-party accredited by the FSC to certify companies to their international standards. Indiana Furniture's FSC certificate number is GFA-COC-002183 and the FSC license code is FSC-C110951. FSC-certified products can be requested at the time of order for most Indiana Furniture products.



The following items are excluded from the 2.9% price increase

Tri-One Multi-Use Tables	01-DUOBEZELW	01-PDUOBEZELW	01-LCOMVGA
Britta Seating	01-DUOBEZELB	01-PDUOBEZELB	01-LCOMHDMI
Factory Installed Grommets	01-DUOBEZELS	01-PDUOBEZELS	01-LCOMRJ45
01-BLUETOOTHSWITCH	01-TRIOBEZELW	01-PTRIOBEZELW	01-POWER
01-MEMORYSWITCH	01-TRIOBEZELB	01-PTRIOBEZELB	01-6JUMP
01-WEPRESENT	01-TRIOBEZELS	01-PTRIOBEZELS	01-5JUMP
			01-4JUMP
			01-2JUMP

Check out lower pricing for Secret Tables on-line!

Warranty	7
General Information And Conditions Of Sale	8

Allegiance™ 1100 Series

How to Order & Specifications	9
Finish, Edge & Pull Options	10
Interior Drawer Dimensions	11
Filing Capabilities	11
Grommet Locations	12
Locking Hutch Doors	12
Executive Double Ped Desk Bow Top	13
Executive Double Ped Desk Rectangular Top	13
Executive Single Ped Desk Bow Top	14
Executive Single Ped Desk Rectangular Top	14
D-Top	15
Executive Return File/File	16
Executive Return Box/Box/File	16
Executive Bridge Full Modesty	17
Executive Bridge Half Modesty	17
Corner Unit	17
Executive Credenza File/File	18
Executive Credenza Box/Box/File	18
Executive Credenza Lateral/Lateral	18
Transaction Riser For Desks/Credenzas	19
Transaction Riser For Returns	19
Transaction Riser For Bridges	19
Storage Credenza Full Pedestal	20
Kneespace Credenza Full Pedestal	20
Four Drawer Lateral File	21
Two Drawer Lateral File	21
Mobile Pedestal	21
Door Hutch	22
Open Hutch	22
Wood Door Wall Mount Hutch	22
Open Shelf Wall Mount Hutch	23
Top Unit Bookcase	23
Bookcases	23
Computer Work Table	23
Circular Top	24
Metal Base	24
Cylinder Base	24
Center Drawer	24
Executive "L" Unit	25
Executive "U" Unit Bow Top Desk Stepped Front	25
Executive "U" Unit P-Top	26
Reception Riser "L" Unit	26
Tackboards	27
Tasklights	27

Canvas™ 6600/6800 Series

How to Order & Specifications	31
Laminate, Edge & Pull Options	32
Interior Drawer Dimensions	33
Filing Capabilities	34
Grommet Locations	35
Locking Hutch Doors	35
Sit-To-Stand Mechanisms	36
Executive Double Ped Desk Bow Top	37-38
Executive Double Ped Desk	
Rectangular Top	37-38
Executive Double 3/4 Ped Desk Bow Top	39
Executive Double 3/4 Ped Desk	
Rectangular Top	39
Executive Single Full Ped Desk Bow Top	40-41
Executive Single Full Ped Desk	
Rectangular Top	40-41
Executive Single 3/4 Ped Desk Bow Top	42
Executive Single 3/4 Ped Desk	
Rectangular Top	42
Executive Curved Single Full Ped Desk	
Bow Top	43
Executive Curved Single Full Ped Desk	
Rectangular Top	43

P-Top Cylinder Base	44
D-Top Cylinder Base	44
Extended D-Top Cylinder Base	45
Executive Full Pedestal Return File/File	46
Executive Full Pedestal Return Box/Box/File	46
Executive 3/4 Pedestal Return Box/File	46
Executive Multi-File Return	
Box/Box/File/Lateral	47
Extended Full Pedestal Return File/File	47
Extended Full Pedestal Return Box/Box/File	47
Executive Bridge Full Modesty	48
Executive Bridge Half Modesty	48
Corner Unit	49
Curved Corner Unit	49
Extended Corner Unit	49
Executive Full Pedestal Credenza File/File	50
Executive Full Pedestal Credenza	
Box/Box/File	50
Executive 3/4 Pedestal Credenza Box/File	50
Executive Full Pedestal Credenza	
Lateral/Lateral	51
Executive Multi-File Pedestal Credenza	
Box/Box/File/Lateral	51
Transaction Riser For Desks/Credenzas	52
Transaction Riser For Returns	52
Transaction Riser For Bridges	52
Storage Credenza Full Pedestal	53
Storage Credenza 3/4 Pedestal	53
Kneespace Credenza Full Pedestal	53
Kneespace Credenza 3/4 Pedestal	53
Double Lateral Credenza	54
Four Drawer Lateral File	54
Two Drawer Lateral File	54
Multi-File	55
Mobile Pedestal	55
Surface Mount Door Hutches	56
Optional Paper Slots For	
Surface Mount Hutches	56
Wall Mount Door Hutches	57
Tall Surface Mount Door Hutches	58
Tall Wall Mount Door Hutches	59
Surface Mount Sliding Door Hutches	60
Wall Mount Sliding Door Hutches	61
Open Storage Wall Mount Hutch	62
Component Top For 15" Deep	
Hutches & Bookcases	62
Storage Tower	63-64
Tall Storage Tower	63-64
Storage Tower Open Bookcase	63
Tall Storage Tower Open Bookcase	65
Top Unit Door Bookcase	65
Tall Top Unit Door Bookcase	65
Storage Cabinet File/File	66
Storage Cabinet Box/Box/File	66-67
Open Storage Cabinet File/File	67
Open Storage Cabinet Box/Box/File	67
Wardrobe/Storage Cabinet	68-69
Visual Board	69
1/4 Round Bookcase	70
Bookcases	70
Top Unit Bookcase	70
Tall Top Unit Bookcase	70
Storage Cabinet With Lateral Files	71
Buffet Credenza	71
Secret Table Peninsula	71
Secret Table Free Standing	71
Secret Table For Benching	72
Computer Work Table	72
Magazine Table	72
End Table	72
Circular Table	73

Cylinder Base	73
Metal Base	73
Center Drawer	73
P-Top Peninsula With Cylinder Base	74
D-Top Peninsula With Cylinder Base	74
Desk Shell	74
Credenza Shell	74
Modular Desk Tops	75
Modular Cabinet Tops	75
Modular Pedestal Box/Box/File	76
Modular Pedestal File/File	76
Modular Pedestal Door Bookcase	76
Modular Pedestal Open Multi-File	77
Modular Pedestal Lateral File	77
Modular Pedestal Multi-File	77
Modular Pedestal Door Bookcase	78
Modular Pedestal Door Bookcase	
W/Open Compartment	78
Modular Pedestal Open Storage	78
Low Height Modular Pedestal Tray/File	79
Low Height Modular Pedestals Open Storage	79
Low Height Modular Pedestal Door	
Bookcases	79
Low Height Modular Pedestal Sliding Door	
Bookcases	79
Seated Height Modular Peninsula Support	80
Standing Height Modular Peninsula Support	81
Layer Support Over Low Height Cabinets	82
O Metal Layer Support Over	
Low Height Cabinets	82
U Metal Layer Support Over	
Low Height Cabinets	82
Modular Modesty Panel	83
Filler Panel	83
Low Height Back Panel	84
Low Height Filler Panel	84
Flipdown Modesty Panel	85
Modular End Panel	85
Support Panel	85
Support T	85
Low Height End Panel	86
Low Height Support Panel	86
Low Height Support T	86
Modular Table Desk Leg With Leveler	87
Modular Table Desk Leg With Caster	87
Acrylic Privacy Panel Or Modesty Panel	87
Component Cushions	88
Stiffener Bar	88
Power Data Port	89
Usb Port	89
Voice Coupler	89
Data Port	89
Pneumatic Table Lift	90
Electric Table Lift	90-91
Battery Pack	91
Sample Arrangements	92-95
Tackboards	96
Tasklights	96
Tall Tackboards	97
Cushions	97

Elevate™ 4000 Series

How to Order & Specifications	99
Finish, Edge & Pull Options	100
Interior Drawer Dimensions	101
Filing Capabilities	101
Grommet Locations	102
Locking Hutch Doors	102
Soft-Closing Drawers	102
Executive Double Ped Desk	103
Freestanding Table Desk With Pedestal	103
Peninsula Desk	103
Executive Single Ped Desk	104

Executive Return Box/Box/File	104	Optional Return Top For 24" Deep Units	135	1/4 Round Bookcase	165
Executive Return File/File	104	Component Pedestal Box/Box/File	136	Wardrobe/Storage	166
Executive Return Multi-File Pedestal Box/Box/File/Lateral	105	Component Pedestal File/File	136	Computer Work Table	166
Corner Unit	105	Component Pedestal False Pedestal	136	End Table	166
Executive Bridge Full Modesty	106	Component Pedestal Door Bookcase	137	Magazine Table	166
Executive Bridge Half Modesty	106	Component Pedestal Lateral File	137	Circular Top	167
Executive Credenza File/File	107	Component Pedestal Double Door Bookcase	137	Cylinder Base	167
Executive Credenza Box/Box/File	107	Optional Modesty Panel	138	Metal Base	167
Executive Credenza Lateral/Lateral	108	Support T	138	Center Drawer	167
Executive Credenza Multi-File Pedestal Box/Box/File/Lateral	108	Sample Arrangements	139-141	Modular Credenza Top	168
Storage Credenza Full Pedestal	109	Tackboards	142	Modular Return Top	168
Kneespace Credenza Full Pedestal	109	Tasklights	142	Modular Bridge Top	169
Double Lateral Credenza	110	Encompass™ 5700/5900 Series		Modular Pedestal Box/Box/File	169
Four Drawer Lateral File	110	How to Order & Specifications	145	Modular Pedestal File/File	169
Two Drawer Lateral File	110	Finish, Edge & Pull Options	146	Modular Pedestal Door Bookcase	170
Mobile Pedestal	110	Interior Drawer Dimensions	147	Modular Pedestal Lateral File	170
Veneer Door Surface Mount Hutches	111	Filing Capabilities	147	Modular Pedestal Multi-File	170
Metallic Frosted Acrylic Door Surface Mount Hutches	112	Grommet Locations	148	Modular Pedestal Door Bookcase	171
Wood Frosted Acrylic Door Surface Mount Hutches	113	Locking Hutch Doors	148	Modular Back Panel	171
Veneer Door Wall Mount Hutches	114	Executive Double Full Ped Desk Bow Top	149	Modular End Panel	172
Metallic Frosted Acrylic Door Wall Mount Hutches	115	Executive Double Full Ped Desk Rectangular Top	149	Modular Support Panel	172
Wood Frosted Acrylic Door Wall Mount Hutches	116	Executive Double 3/4 Ped Desk Bow Top	150	Modular T Support	172
Veneer Door Surface Mount Hutches Paperslots	117	Executive Double 3/4 Ped Desk Rectangular Top	150	Modular Filler Panel	172
Metallic Frosted Acrylic Door Surface Mount Hutches Paperslots	118	Arc Table Desk	150	Sample Arrangements	173-174
Wood Frosted Acrylic Door Surface Mount Hutches Paperslots	119	Executive Single Full Ped Desk Bow Top	151	Tackboards	175
Veneer Door Wall Mount Hutches Paperslots	120	Executive Single Full Ped Desk Rectangular Top	151	Tasklights	175
Metallic Frosted Acrylic Door Wall Mount Hutches Paperslots	121	P-Top	153		
Wood Frosted Acrylic Door Wall Mount Hutches Paperslots	122	D-Top	153	Gesso® 6500/6700 Series	
Bookcases	123	Executive Return Full Pedestal File/File	154	How to Order & Specifications	179
Tall Top Unit Bookcase	123	Executive Return Full Pedestal Box/Box/File	154	Finish, Edge & Pull Options	180
Top Unit Bookcase	123	Executive Return 3/4 Pedestal Box/File	154	Interior Drawer Dimensions	181
Flat Panel Tv Hutch	124	Executive Return Multi-File Pedestal Box/Box/File/Lateral	154	Filing Capabilities	182
Veneer Door Storage Tower	124	Executive Bridge Full Modesty	155	Grommet Locations	183
Metallic Frosted Acrylic Door Storage Tower	124	Executive Bridge Half Modesty	155	Locking Hutch Doors	183
Wood Frosted Acrylic Door Storage Tower	124	Corner Unit	155	Sit-To-Stand Mechanisms	184
Veneer Door Tall Storage Tower	125	Executive Credenza Full Pedestal File/File	156	Executive Double Ped Desk Bow Top	185-186
Metallic Frosted Acrylic Door Tall Storage Tower	125	Executive Credenza Full Pedestal Box/Box/File	156	Executive Double Ped Desk Rectangular Top	185-186
Wood Frosted Acrylic Door Tall Storage Tower	125	Executive Credenza 3/4 Pedestal Box/File	156	Executive Double 3/4 Ped Desk Bow Top	187
Veneer Door Storage Tower	126	Executive Credenza Full Pedestal Lateral/Lateral	157	Executive Double 3/4 Ped Desk Rectangular Top	187
Metallic Frosted Acrylic Door Storage Tower	126	Executive Credenza Full Pedestal Box/Box/File/Lateral	157	Executive Single Full Ped Desk Bow Top	188-189
Wood Frosted Acrylic Door Storage Tower	126	Transaction Risers	158	Executive Single Full Ped Desk Rectangular Top	188-189
Wardrobe/Storage Cabinet	127	Storage Credenza Full Pedestal	159	Executive Single 3/4 Ped Desk Bow Top	190
Veneer Door Storage Cabinet	128-129	Storage Credenza 3/4 Pedestal	159	Executive Single 3/4 Ped Desk Rectangular Top	190
Metallic Frosted Acrylic Door Storage Cabinet	128-130	Kneespace Credenza Full Pedestal	159	Executive Curved Single Full Ped Desk Bow Top	191
Wood Frosted Acrylic Door Storage Cabinet	128-130	Kneespace Credenza 3/4 Pedestal	159	Executive Curved Single Full Ped Desk Rectangular Top	191
Optional Overhead Top For 15" Deep Units	131	Four Drawer Lateral File	160	P-Top Cylinder Base	192
Optional Overhead Top For 24" Deep Units	131	Two Drawer Lateral File	160	D-Top Cylinder Base	192
Computer Workstation	132	Multi-File	161	Extended D-Top Cylinder Base	193
Magazine Table	132	Double Lateral Credenza	161	Executive Full Pedestal Return File/File	194
End Table	132	Mobile Pedestal	161	Executive Full Pedestal Return Box/Box/File	194
Center Drawer	132	Wood Door Surface Mount Hutch	162	Executive Multi-File Return Box/Box/File/Lateral	195
Square Conference Table Tops	133	Wood Framed Acrylic Door Surface Mount Hutch	162-163	Extended Full Pedestal Return File/File	195
Square Table Base	133	Frosted Acrylic Door Surface Mount Hutch	162-163	Extended Full Pedestal Return Box/Box/File	195
Square Table Legs	133	Surface Mount Hutch	163	Executive Bridge Full Modesty	196
Optional Credenza Top For 24" Deep Units	134	Wood Door Wall Mount Hutch	164	Executive Bridge Half Modesty	196
		Wood Framed Acrylic Door Wall Mount Hutch	164	Corner Unit	197
		Frosted Acrylic Door Wall Mount Hutch	164	Curved Corner Unit	197
		Top Unit Bookcase	165	Extended Corner Unit	197
		Bookcases	165	Executive Full Pedestal Credenza File/File	198
				Executive Full Pedestal Credenza Box/Box/File	198
				Executive 3/4 Pedestal Credenza Box/File	198
				Executive Full Pedestal Credenza	

Lateral/Lateral	199	Low Height Modular Pedestals		Executive Return Full Pedestal File/File	259
Executive Multi-File Pedestal Credenza		Open Storage	227	Executive Return Full Pedestal	
Box/Box/File/Lateral	199	Low Height Modular Pedestal Door		Box/Box/File Half Modesty	259
Transaction Riser For Desks/Credenzas	200	Bookcases.	227	Executive Return Full Pedestal	
Transaction Riser For Returns.	200	Low Height Modular Pedestal Sliding Door		File/File Half Modesty	259
Transaction Riser For Bridges	200	Bookcases.	227	Executive Return 3/4 Pedestal Box/File	260
Storage Credenza Full Pedestal	201	Seated Height Modular Peninsula Support	228	Executive Return Multi-File Pedestal	
Storage Credenza 3/4 Pedestal	201	Standing Height Modular Peninsula Support	229	Box/Box/File/Lateral	260
Kneespace Credenza Full Pedestal	201	Layer Support Over Low Height Cabinets	230	Executive Bridge Full Modesty	260
Kneespace Credenza 3/4 Pedestal	201	O Metal Layer Support		Executive Bridge Half Modesty	260
Double Lateral Credenza	202	Over Low Height Cabinets.	230	Corner Unit	261
Four Drawer Lateral File	202	U Metal Layer Support		Executive Credenza Full Pedestal	
Two Drawer Lateral File	202	Low Height Cabinets.	230	Box/Box/File	261
Multi-File	203	Modular Modesty Panel	231	Executive Credenza Full Pedestal File/File.	261
Mobile Pedestal	203	Filler Panel	231	Executive Credenza Full Pedestal	
Wood Door Surface Mount Hutches	204	Low Height Back Panel	232	Box/Box/File Half Modesty	262
Optional Paper Slots For		Low Height Filler Panel	232	Executive Credenza Full Pedestal File/File	
Surface Mount Hutches	204	Flipdown Modesty Panel	233	Half Modesty	262
Wood Door Wall Mount Hutches	205	Modular End Panel	233	Executive Credenza 3/4 Pedestal Box/File.	262
Tall Surface Mount Door Hutches	206	Support Panel	233	Executive Credenza Lateral File	263
Tall Wall Mount Door Hutches.	207	Support T	233	Executive Credenza 36"W Lateral File	
Surface Mount Sliding Door Hutches.	208	Low Height End Panel	234	Half Modesty	263
Wall Mount Sliding Door Hutches.	209	Low Height Support Panel.	234	Executive Credenza Multi-File	
Open Storage Wall Mount Hutch	210	Low Height Support T	234	Box/Box/File/Lateral	263
Component Top For 15" Deep		Modular Table Desk Leg With Leveler	235	Transaction Risers	264
Hutches & Bookcases	210	Modular Table Desk Leg With Caster.	235	Storage Credenza Full Pedestal	265
Storage Tower	211-212	Acrylic Privacy Panel Or Modesty Panel	235	Storage Credenza 3/4 Pedestal	265
Tall Storage Tower.	211-212	Component Cushions	236	Kneespace Credenza Full Pedestal	265
Storage Tower Open Bookcase.	211	Stiffener Bar.	236	Kneespace Credenza Full Pedestal	
Tall Storage Tower Open Bookcase	213	Power Data Port	237	Half Modesty	265
Top Unit Door Bookcase	213	Usb Port	237	Kneespace Credenza 3/4 Pedestal.	266
Tall Top Unit Door Bookcase	213	Voice Coupler.	237	Double Lateral Credenza	266
Storage Cabinet File/File.	214	Data Port	237	Four Drawer Lateral File	266
Storage Cabinet Box/Box/File	214-215	Pneumatic Table Lift.	238	Three Drawer Lateral File	266
Open Storage Cabinet File/File	215	Electric Table Lift	238-239	Two Drawer Lateral File	267
Open Storage Cabinet Box/Box/File.	215	Battery Pack.	239	Multi-File	267
Wardrobe/Storage Cabinet.	216-217	Sample Arrangements	240-243	Mobile Pedestal	267
Visual Board.	217	Tackboards	244	Wood Door Surface Mount Hutch	268
1/4 Round Bookcase.	218	Tasklights	244	Acrylic Door Surface Mount Hutch.	268
Bookcases.	218	Cushions	245	Optional Paper Slots For	
Top Unit Bookcase	218	Madera™ 1400/1600 Series		Surface Mount Hutches	268
Tall Top Unit Bookcase	218	How to Order & Specifications.	249	Wood Door Wall Mount Hutch	269
Storage Cabinet With Lateral Files.	219	Finish, Edge & Pull Options	250	Acrylic Door Wall Mount Hutch	269
Buffet Credenza.	219	Interior Drawer Dimensions	251	Top Unit Bookcase	269
Secret Table Peninsula	219	Filing Capabilities	252	Bookcases.	270
Secret Table Free Standing	219	Grommet Locations	253	Wardrobe/Storage Cabinet	270
Secret Table For Benching.	220	Locking Hutch Doors	254	Wardrobe/Storage Cabinet File/File	271
Computer Work Table	220	Pull-Out Writing Shelves.	254	Wardrobe/Storage Cabinet Box/Box/File	271
Magazine Table	220	Executive Double Full Ped Desk Bow Top	255	Wood Doors Storage Cabinet File/File	271
End Table	220	Executive Double Full Ped Desk		Work Table	272
Circular Table	221	Bow Top Overhang	255	Computer Work Table	272
Cylinder Base	221	Executive Double Full Ped Desk		Circular Conference Table	272
Metal Base	221	Rectangular Top	255	Cylinder Base	272
Center Drawer	221	Executive Double Full Ped Desk		Magazine Table	273
P-Top Peninsula With Cylinder Base	222	Rectangular Top Overhang	255	Lamp Table.	273
D-Top Peninsula With Cylinder Base.	222	Executive Double 3/4 Ped Desk Bow Top.	256	End Table	273
Desk Shell.	222	Executive Double 3/4 Ped Desk		Center Drawer	273
Credenza Shell.	222	Rectangular Top	256	Bow Top Desk Worksurface.	274
Modular Desk Tops	223	Executive Single Full Ped Desk Bow Top	256	Desk Worksurface 36" Deep	274
Modular Cabinet Tops.	223	Executive Single Full Ped Desk		Desk Worksurface 30" Deep	275
Modular Pedestal Box/Box/File	224	Bow Top Overhang	257	Modular Credenza Top 24" Deep	276
Modular Pedestal File/File.	224	Executive Single Full Ped Desk		Modular Return Top	277
Modular Pedestal Door Bookcase	224	Rectangular Top	257	24" Deep	277
Modular Pedestal Open Multi-File	225	Executive Single Full Ped Desk		Modular Bridge Top	277
Modular Pedestal Lateral File	225	Rectangular Top Overhang	257	24" Deep	277
Modular Pedestal Multi-File.	225	Executive Double 3/4 Ped Desk Bow Top.	258	Modular Pedestal Box/Box/File	278
Modular Pedestal Door Bookcase	226	Executive Single 3/4 Ped Desk		Modular Pedestal File/File.	278
Modular Pedestal Door Bookcase		Rectangular Top	258	Modular Pedestal Shell.	278
W/Open Compartment	226	P-Top	258	Modular Pedestal Door Bookcase	279
Modular Pedestal Open Storage.	226	D-Top.	258	Modular Pedestal Lateral File	279
Low Height Modular Pedestal Tray/File.	227	Executive Return Full Pedestal		Modular Pedestal Multi-File.	279
		Box/Box/File	259		

Modular Pedestal Door Bookcase	280	Circular Table	313	Open Storage Wall Mount Hutch	351
Modular Back Panel	280	Cylinder Base	314	Wood Door Wall Mount Hutch	351
Seated Height Modular Peninsula Support	281	Metal Base	314	Acrylic Door Wall Mount Hutch	351
Modular End Panel	282	X Base	314	Open Storage Corner Hutch	352
Modular Support Panel	282	Bow Top Worksurface	315	Top Unit Bookcase	352
Modular T Support	282	Desk Worksurface	315	1/4 Round Bookcases	352
Modular Filler Panel	282	Worksurface 30" Deep	316	Bookcases	352
Stiffener Bar	282	Worksurface 24" Deep	317	Wood Door Storage Tower	353-354
Sample Arrangements	283-284	Extended Corner Angled Top	318	Acrylic Door Storage Tower	353-354
Box Drawer Divider	285	Extended Corner Cockpit Top	318	Portable Tower Unit	353-354
Tackboards	285	P-Top With Cylinder Base	319	Wardrobe/Storage	355
Tasklights	285	D-Top With Cylinder Base	319	Wood Doors Video Cabinet Box/Box/File	356
Resilience™ 3800 Series		Pedestal Box/Box/File	320	Wood Doors Video Cabinet File/File	356
How to Order & Specifications	287	Pedestal File/File	320	Double Wood Doors Video Cabinet	356
Laminate, Edge & Pull Options	288	Pedestal Shell	320	Wood Doors Storage Cabinet Box/Box/File	357
Interior Drawer Dimensions	289	Credenza/Return Pedestal Door Bookcase	321	Wood Doors Storage Cabinet File/File	357
Filing Capabilities	289	Lateral File File/File	321	Double Wood Doors Storage Cabinet	357
Grommet Locations	290	Lateral File Box/Box/File/Lateral	321	Computer Work Table	358
Locking Hutch Doors	290	Lateral File File/File/Lateral	321	Magazine Table	358
Resilience Laminate Offering	290	Door Bookcase	322	Lamp Table	358
Executive Double Ped Desk Bow Top	291	Open Bookcase	322	Circular Table	359
Executive Double Ped Desk		Four Drawer File	322	Cylinder Base	359
Rectangular Top	292	Three Drawer File	322	Center Drawer	359
Executive Single Ped Desk Bow Top	293	Modesty Panel	323	Bow Top Worksurface	360
Executive Single Ped Desk Rectangular Top	293	Support T	324	Desk Worksurface	360
Cockpit Desk Bow Top	293	Ganging Bracket	324	Worksurface 30" Deep	361
Cockpit Shell Desk Bow Top	293	Sample Arrangements	325-328	Worksurface 24" Deep	362
P-Top With End Support Cylinder Base	294	Attachment Instructions	329	Modular Return Top	363
D-Top With End Support Cylinder Base	294	Tackboards	330	P-Top With Cylinder Base	364
Executive Return File/File	295	Tasklights	330	D-Top With Cylinder Base	364
Executive Return Box/Box/File	295			Component Pedestal Box/Box/File	365
Cockpit Return File/File	295	Revolutions™ 4200 Series		Component Pedestal File/File	365
Cockpit Return Box/Box/File	295	How to Order & Specifications	333	Component Pedestal Shell	365
Executive Bridge Full Modesty	296	Finish, Edge & Pull Options	334	Component Computer Pedestal	366
Executive Bridge Half Modesty	296	Interior Drawer Dimensions	335	Component Open Bookcase Pedestal	366
Cockpit Bridge	296	Filing Capabilities	335	Component Bookcase Pedestal	366
Cockpit Bridge Half Modesty	296	Grommet Locations	336	Component Door Bookcase Pedestal	366
Corner Unit	297	Locking Hutch Doors	336	Component Lateral File File/File	367
Cockpit Corner Unit	297	Executive Double Ped Desk Bow Top	337	Component Lateral File	
Extended Corner Unit Angled	298	Executive Double Ped Desk		Box/Box/File/Lateral	367
Extended Cockpit Corner Unit Curved	298	Rectangular Top	338	Component Lateral File File/File/Lateral	367
Executive Credenza File/File	299	Executive Single Ped Desk Bow Top	339	Component Lateral File Open Shelf/Lateral	367
Executive Credenza Box/Box/File	299	Executive Single Ped Desk Rectangular Top	339	Component Door Bookcase	368
Transaction Risers	300	Cockpit Desk Bow Top	339	Component Open Bookcase	368
Storage Credenza	301	Cockpit Shell Desk Bow Top	339	Component Four Drawer File	368
Kneespace Credenza	302	P-Top Peninsula Desk	340	Component Three Drawer File	368
Four Drawer Lateral File	303	D-Top Peninsula Desk	340	Component Modesty Panel	369
Three Drawer Lateral File	303	Executive Return File/File	341	Support T	370
Two Drawer Lateral File	303	Executive Return Box/Box/File	341	Ganging Bracket	370
Mobile Pedestal Box/Box/File	304	Cockpit Return File/File	341	Sample Arrangements	371-376
Mobile Pedestal File/File	304	Cockpit Return Box/Box/File	341	Attachment Instructions	377
Surface Mount Open Hutch	305	Executive Bridge Full Modesty	342	Tackboards	378
Surface Mount Door Hutch	305	Executive Bridge Half Modesty	342	Tasklights	378
Open Storage Wall Mount Hutch	306	Cockpit Bridge	342		
Wall Mount Hutch	306	Cockpit Bridge Half Modesty	342	Phoenix™ 2100 Series	
Open Storage Corner Hutch	306	Corner Unit	343	How to Order & Specifications	379
Top Unit Bookcase	307	Cockpit Corner Unit	343	Finish, Edge & Pull Options	380
1/4 Round Bookcases	307	Executive Credenza File/File	344	Interior Drawer Dimensions	381
Bookcases	307	Executive Credenza Box/Box/File	344	Filing Capabilities	381
Storage Tower	308	Transaction Risers	345	Grommet Locations	382
Portable Tower Unit	308	Storage Credenza	346	Locking Hutch Doors	382
Storage	309	Kneespace Credenza	347	Executive Double Ped Desk Bow Top	383
Storage Unit	309	Four Drawer Lateral File With		Executive Double Ped Desk	
Video Cabinet Box/Box/File	310	Overhead Storage	348	Rectangular Top	383
Video Cabinet File/File	310	Four Drawer Lateral File	348	Executive Double Ped Desk	383
Visual Board	310	Three Drawer Lateral File	348	Table Desk	383
Wardrobe/Storage	311	Two Drawer Lateral File	348	Executive Single Ped Desk Bow Top	384
Computer Work Table	312	Mobile Pedestal Box/Box/File	349	Executive Single Ped Desk	
Printer Table	312	Mobile Pedestal File/File	349	Rectangular Top	384
Lamp Table	312	Open Storage Surface Mount Hutch	350	P-Top	385
Magazine Table	312	Wood Door Surface Mount Hutch	350	D-Top	385
Center Drawer	313	Acrylic Door Surface Mount Hutch	350	Executive Return File/File	386

Executive Return Box/Box/File	386	Tackboards	421	Credenza	447
Executive Return Multi-File Pedestal		Tasklights	421	Double Bookcase	447
Box/Box/File/Lateral	386	Jefferson™ 4600 Series		Wall Unit With Grille Doors	448
Executive Bridge Full Modesty	387	How to Order & Specifications	423	Sample Arrangements	448-449
Executive Bridge Half Modesty	387	Finish, Edge Pull & Molding Options	424	Tackboards	450
Corner Unit	387	Interior Drawer Dimensions	425	Tasklights	450
Executive Credenza File/File	388	Filing Capabilities	425	Wilmington™ 3600 Series	
Executive Credenza Box/Box/File	388	Grommet Locations	426	How to Order & Specifications	453
Executive Credenza Lateral/Lateral	388	Modular Component Molding	426	Finish, Edge & Pull Options	454
Executive Credenza Box/Box/File/Lateral	388	Approach Side Dictation Slides	426	Interior Drawer Dimensions	455
Transaction Risers	389	Locking Pedestals	426	Filing Capabilities	455
Storage Credenza Full Pedestal	390	Locking Hutch Doors	426	Grommet Locations	456
Kneespace Credenza Full Pedestal	390	High Sheen Wood Veneer Tops	426	Locking File Drawers	456
Four Drawer Lateral File	391	Executive Double Ped Desk Tray/File/Box	427	Locking Hutch Doors	456
Two Drawer Lateral File	391	Executive Double Ped Desk Box/File	427	High Sheen Wood Veneer Tops	456
Top Unit Bookcase	392	Table Desk	428	Executive Double Ped Desk	457
Hutch	392	Executive Single Ped Desk Box/File	428	Executive Single Ped Desk	457
Wood Door Wall Mount Hutch	392	P-Top	428	Table Desk	457
Bookcases	393	Executive Return Box/File	429	Executive Return Tray/File/Box	458
Double Wardrobe/Storage	393	Executive Bridge Full Modesty	429	Executive Bridge Full Modesty	458
Computer Work Table	394	Executive Bridge Half Modesty	429	Executive Bridge Half Modesty	458
End Table	394	Corner Unit	430	Corner Unit	459
Magazine Table	394	Executive Credenza Box/File	430	Executive Credenza Tray/File/Box	459
Center Drawer	394	Executive Credenza Lateral/Lateral	430	Executive Credenza Lateral File	459
Circular Top	395	Transaction Risers	431	Transaction Risers	460
Cylinder Base	395	Storage Credenza Full Pedestal	432	Storage Credenza	461
Square Table Base	395	Kneespace Credenza Full Pedestal	432	Kneespace Credenza	461
Sample Arrangements	396-397	Double Lateral Credenza Full Pedestal	432	Double Lateral File Credenza	462
Tackboards	398	Wood Door Surface Mount Hutch	433	Four Drawer Lateral File	462
Tasklights	398	Mesh Door Surface Mount Hutch	433	Two Drawer Lateral File	462
		Glass Door Surface Mount Hutch	433	Wood Door Surface Mount Hutch	463
Arlington™ 2900 Series		Wood Insert Door Surface Mount Hutch	433	Acrylic Door Surface Mount Hutch	463
How to Order & Specifications	401	Wood Door Wall Mount Hutch	434	Wood Door Wall Mount Hutch	464
Finish, Edge & Pull Options	402	Mesh Door Wall Mount Hutch	434	Acrylic Door Wall Mount Hutch	464
Interior Drawer Dimensions	403	Glass Door Wall Mount Hutch	434	Top Unit Bookcase	465
Filing Capabilities	403	Wood Insert Door Wall Mount Hutch	434	Bookcases	465
Grommet Locations	404	Vertical Hutch Open Storage		Double Wardrobe/Storage	465
Locking File Drawers	404	Surface Mount	435	Computer Work Table	466
Locking Hutch Doors	404	Vertical Hutch Grille Doors		End Table	466
Hardwood Drawer Interiors	404	Surface Mount	435	Lamp Table	466
Executive Double Ped Desk	405	Vertical Hutch Wood Doors		Magazine Table	467
Table Desk	405	Surface Mount	436	Circular Table	467
Executive Single Ped Desk	406	Vertical Hutch Glass Doors		Sample Arrangements	468
Executive Return Tray/File/Box	407	Surface Mount	436	Tackboards	469
Operational Return Box/File	407	Four Drawer Lateral File	437	Tasklights	469
Executive Bridge Full Modesty	408	Two Drawer Lateral File	437		
Executive Bridge Half Modesty	408	Top Unit Bookcase	438	Accessories	
Corner Unit	408	Bookcases	438	CPU Holder	473
Executive Credenza Tray/File/Box	409	Wardrobe/Storage Cabinet	438	Dual Articulating Monitor Arm	473
Executive Credenza Lateral/Lateral	409	Computer Work Table	439	Single Monitor Arm	473
Transaction Risers	410	End Table	439	Keyboard Mechanisms	474-476
Storage Credenza Full Pedestal	411	Lamp Table	439	Floor Lamp	477
Kneespace Credenza Full Pedestal	411	Magazine Table	439	Led Desk Lamp	477
Double Lateral File Credenza	412	Keyboard Flip Drawer	440	Fluorescent Tasklights	477
Four Drawer Lateral File	412	Circular Tables	440	Led Tasklight	477
Two Drawer Lateral File	412	Overhead Cornice Frame	441	Round Grommet	478
Wood Door Surface Mount Hutch	413	Overhead Cornice Frame With Insert Panel	441	Rectangular Grommet	478
Acrylic Door Surface Mount Hutch	413	Bookcase Top	441	Training Table Power & Data Vault	479
Wood Door Wall Mount Hutch	414	Bookcase	442	Hotel Desk Power & Data Vault	479
Acrylic Door Wall Mount Hutch	414	Grille Mesh Door Bookcase	442	Conference Table Power & Data Vault	479
Top Unit Bookcase For 30" Lateral	415	Wood Door Bookcase	442	Reveal Power & Data	479
Top Unit Bookcase For 36" Lateral	415	Glass Door Bookcase	442	Oasis Mini Power & Data	480
Door Bookcase	415	Modular Pedestal	443	Interact Power & Data	480
Bookcases	416	Modular Back Panel	443	Data Port 4	480
Double Wardrobe/Storage	416	Bookcase Base	443	Power 440	480
Mobile Computer Cart	417	Cabinet/Credenza Top	444	Pneumatic Table Lift	481
Computer Work Table	417	Cabinet/Credenza Base	444	Electric Table Lift With Caster	481
Computer Desk With Hutch	417	Modular Storage	445	Electric Table Lift	482
Work Table	417	Modular Storage Box/Box/File	445	Electric Table Lift	482
Circular Table	418	Modular Storage File/File	445	Battery Pack	482
Conference Table One-Piece Top	418	Single Cabinet Unit	446	Power Strip	483
Conference Table Two-Piece Top	418	Vertical Storage Unit	446	Wire Managers	483
Sample Arrangements	419-420				

Subject to the limitations set forth in this warranty, Indiana Furniture Industries, Inc. (“**Indiana Furniture**”) warrants to the original purchaser all product in this price list (“**Product**”) to be free from defects in material and workmanship given normal use for a twelve year period from the date of manufacture. During the applicable warranty period, Indiana Furniture, as its sole obligation, will repair or replace (in Indiana Furniture’s sole discretion) any Product, part, or component covered by this warranty and sold after March 1, 2016, which fails under normal use as a result of a defect in material or workmanship. Normal use is defined as the equivalent of a single shift, 40-hour work week. Indiana Furniture will repair or replace the defective Product, part, or component with a comparable Product, part or component.

Warranty periods are limited for certain Products and parts as follows:

12-year Warranty (from the date of manufacture)

- Seating Mechanisms
- Veneers
- Laminates
- Casters and Glides

5-year Warranty (from the date of manufacture)

- Triple Play Series
- Electrical Components
- Pneumatic Cylinders
- Textiles, Foam, and Decorative Trim
- Swivel Arm Pads
- Keyboard kits
- Lighting

2-year Warranty (from the date of manufacture)

- All Sit-To-Stand Mechanisms

THIS WARRANTY DOES NOT COVER:

- Damage caused by a carrier or third party
- Normal or routine wear and tear
- Appearance, durability, quality, behavior, colorfastness or any other attribute of customer’s own materials or any non-standard Indiana Furniture material (including Maharam, Momentum, Mayer, UltraFabrics) specified by the customer and applied to a Product
- Color, grain or texture of wood, laminate and other covering materials
- Changes in wood or fabric color due to aging or exposure to light

As the manufacturer of the Product, Indiana Furniture stands behind its craftsmanship and pledges to do everything it can to reasonably resolve, as quickly as possible, any problems you may have with the Product within the terms and conditions of this warranty.

If you encounter a defect covered by the foregoing warranty, you should contact the dealer from whom you purchased the Product. If the dealer is unable to resolve your warranty issues, you should contact Indiana Furniture. Please ensure that you have all of the pertinent facts when contacting the dealer or Indiana Furniture, including the model number and factory order number from the inspection label attached to the Product.

INDIANA FURNITURE IS NOT PROVIDING, AND SPECIFICALLY DISCLAIMS, ANY OTHER WARRANTIES FOR THE PRODUCTS, EXPRESS OR IMPLIED, INCLUDING ANY IMPLIED WARRANTY OF MERCHANTABILITY OR FITNESS FOR A PARTICULAR PURPOSE. INDIANA FURNITURE SHALL NOT BE LIABLE TO PURCHASER OR ANY THIRD PARTY FOR CONSEQUENTIAL, INCIDENTAL, INDIRECT OR SPECIAL DAMAGES, INCLUDING, WITHOUT LIMITATION, DAMAGES ARISING OUT OF OR RESULTING IN ANY MALFUNCTIONS, DELAYS, LOSS OF PROFIT, INTERRUPTION OF BUSINESS, PERSONAL INJURY, BODILY INJURY, DEATH, DISMEMBERMENT, OR PROPERTY DAMAGE.

Indiana Furniture Industries, Inc.
Attn: Customer Service
1224 Mill Street, P.O. Box 270
Jasper, Indiana 47547-0270
800.422.5727
Fax 812.482.9035
custserv@indianafurniture.com

ORDERING INFORMATION

All orders should be emailed to neworders@indianafurniture.com. Orders can be faxed to 812-482-9035. Orders can also be mailed to:

Indiana Furniture
P.O. Box 270
1224 Mill Street
Jasper, IN 47547-0270

ORDER PROCEDURE

All orders must include purchase order number, billing address, ship-to address and phone number, and any special instructions.

When ordering casegoods, give complete quantity, model number, finish and any other options. When ordering seating, give complete quantity, model number, finish, fabric and any other options.

Within each series, an example of "How to Order" is illustrated at the bottom of each page. For further clarification of order procedure, contact Customer Service.

PRICING

All prices shown are suggested retail prices F.O.B. Point of Origin, freight prepaid and allowed to one continental US destination. Prices, specifications and materials are subject to change without notice. Possession and/or distribution of this price list does not in itself constitute an offer to sell. Orders can be received only from authorized Indiana Furniture dealers. Orders will be billed at prices prevailing at time of shipment, unless acknowledged prior to the effective date of the price change, in which case billing will be at the price acknowledged.

ACKNOWLEDGEMENT

All orders will be acknowledged promptly, showing how the order was entered, its approximate shipping date and other pertinent information. This acknowledgement is the final agreement between the customer and Indiana Furniture and is the exclusive statement of the terms thereof. Please examine this acknowledgement carefully and advise Indiana Furniture immediately of any discrepancies.

BUYER'S OBLIGATION: RIGHTS OF SELLER

If Indiana Furniture shall at any time doubt Buyer's financial responsibility, Indiana Furniture may decline to make shipments hereunder except upon receipt of cash payment in advance or security or other proof of responsibility satisfactory to Indiana Furniture. If buyer fails in any way to fulfill the terms and conditions set forth herein, Indiana Furniture may defer shipments until such default is corrected. Remedies provided herein shall be in addition to, and not in lieu of other remedies. Buyer agrees to abide by payment terms as listed on invoice. Buyer shall pay all reasonable costs and expenses, including attorney and collection fees, and late fees, incurred by Seller in connection with any amounts due for goods ordered.

CANCELLATIONS AND CHANGES

Due to immediate production on build to order items, all orders are considered firm and are not subject to cancellation or change without approval from Indiana Furniture. All approved changes are subject to additional charges and revised lead times.

PRODUCT DESIGN AND SPECIFICATION CHANGES

Indiana Furniture reserves the right to make changes in design and construction or discontinue products without prior notice.

REPAIR CHARGES

Indiana Furniture will only pay repair charges if Customer Service gives prior written authorization. No repair charge will be paid without advance approval at which time you will be issued a repair authorization number that will allow you to invoice Indiana Furniture for the completed work.

WAREHOUSE STORAGE CHARGES

If a shipment is held beyond 14 calendar days at your request a **.067% per calendar day** (2% per month) storage charge will be assessed. The effective date will be 14 calendar days after the acknowledged ship date. Further, the prices applied to the order will be those in effect at the time of shipment.

DAMAGED MERCHANDISE

The consignee is responsible for filing claims with the carrier for damage and shortages. Claims for both obvious and concealed damage must be filed within 15 calendar days, and the damaged merchandise must not have been moved from the original receiving location. All damaged merchandise, including the cartons and packing materials, must be retained for inspection by either the carrier or by an Indiana Furniture Sales Representative. Indiana Furniture reserves the right to select the most cost effective way to repair or replace the damaged item. Once you have notified the carrier, please contact Customer Service for further assistance.

Obvious Damage/Missing Cartons - Do not refuse merchandise damaged in transit. Indiana Furniture recommends the consignee inspect all merchandise upon arrival. If a shipment is received damaged or short, note all information on carrier's copy and your copy of freight bill and delivery receipt. Notify the delivering carrier and file a claim immediately. Pending the results of your claim, either Indiana Furniture or the carrier will cover 100% of the cost to repair or replace the damaged or missing item.

Concealed Damage - If concealed damage is discovered, notify the delivering carrier at once and request an inspection. This must be done within **15 calendar days of delivery**. If the carrier will not perform the inspection, you should prepare an affidavit that you contacted them, noting the time and date, and that they failed to comply with your request. This, along with the other papers in your possession, will support the claim. Pending the results of your claim, the cost to repair or replace the item will be covered 1/3 by the carrier and 2/3 by Indiana Furniture for shipments less than a full truckload and 100% by Indiana Furniture for shipments of full truckloads.

RETURN MERCHANDISE

Merchandise will not be accepted for return without an RGA (Return Goods Authorization) issued by Indiana Furniture. We will consider issuing RGA's for the following reasons:

1. Manufacturing defect (inspected by Indiana Furniture representative)
2. Indiana Furniture order processing error
3. Shipping error
4. Mis-marked cartons
5. Duplicated shipments

If you have any questions as to whether your reason for return qualifies for consideration, please contact your Customer Service Representative. Merchandise must be returned within 60 days of the RGA issued date, or within 60 days upon receipt of replacement product to receive credit. Returns due to mis-marked cartons must also be returned in the original cartoning, with shipping labels intact, to receive credit.

All merchandise being returned must be properly packed and protected to ensure no further damage is incurred during transportation back to an Indiana Furniture facility. Upon receipt, all returned merchandise will be thoroughly inspected and the results compared to the reason for return stated on the RGA. Any discrepancies, such as additional damage, signs of usage, missing parts, etc., will result in an adjustment to the amount of credit issued.

DELIVERY AND FREIGHT CHARGES

All shipments are F.O.B. Point of Origin, Jasper, IN, freight prepaid and allowed dock to dock on 53' trailer. Ownership and responsibility of the merchandise becomes that of the buyer upon delivery to the freight company. Shipments into Alaska, Hawaii, Canada, Mexico, Puerto Rico and other exports are freight prepaid and allowed to port of exit.

Indiana Furniture reserves the right to select the most appropriate carrier and routing on all shipments. Indiana Furniture will attempt to accommodate requests for favored carriers and delivery times. Deliveries requested Monday through Thursday, after 3pm, will be assessed a \$250 per truck after hours fee. Deliveries requested after 3pm on Friday or on weekends, will be assessed a \$500 per truck weekend delivery fee.

Inside delivery and installation services are not included in the pricing shown. Any deviation from dock-to-dock delivery, such as but not limited to, non-dock, residential, or inside delivery must be specified on the order. Should these services be requested or required, all charges incurred will be charged to the "Sold To" of the order.

Orders of less than 750 pounds will be assessed a handling charge of \$75.00 Net Per Order. (This will be waived for items shipped via a small package carrier.)

BIFMA AND ANSI TESTING

Indiana Furniture is a member of the Business and Institutional Furniture Manufacturer's Association (BIFMA). Tests developed by the BIFMA and approved by the American National Standards Institute (ANSI) determine the strength and durability of casegoods and seating in its everyday use. Although this testing does not serve as a warranty or guarantee, Indiana Furniture products within this price list have been tested by an independent verifying body and meet or exceed applicable BIFMA and ANSI standards.

AllegianceTM

Casegoods Collection

How to Order

MODEL NO.	DESCRIPTION
11-3672BDP	Finish LW
	Top Surface P
	Edge X
	Pull NBT

All options must be labeled and specified.



Specifications



veneer

Exposed surfaces feature select grade sliced American Black Walnut hardwood veneers carefully selected and matched to assure proper balance and consistency.

tops

Wood veneer worksurfaces are 5-ply balanced construction, 1" thick with solid hardwood rims. High pressure laminate worksurfaces are 3-ply balanced construction, 1" thick with solid hardwood rims. Worksurfaces feature shaped edge profiles on all four sides. Grain direction runs left to right unless noted.

chassis construction

Veneer chassis are fastened by screws, glue, and metal fasteners to assure maximum strength. Units feature finished backs unless noted. Units ship assembled. All units ship with leveling glides.

drawers

All drawer fronts are standard with matched wood grain faces. Fronts are 3-ply construction and 3/4" thick. Drawer sides and backs are wood-grain vinyl wrapped, 1/2" thick. Box and file drawers have 1/8" thick hardboard bottoms. Lateral file drawers feature 1/4" thick hardboard bottoms. Drawers feature 5-sided construction allowing for easy removal of drawer fronts.

drawers suspensions

File drawers have full extension, telescopic action slides with precision steel ball bearings. Box drawers have 3/4" extension nylon roller suspensions. All suspensions have a lifetime warranty.

filing hardware

All file drawers are standard with filing systems designed to accommodate a variety of filing requirements. Letter width file drawers provide letter filing front to back, and letter or legal filing side to side.

locking

All desks, credenzas, and lateral files feature locking file drawers. Removable lock cylinders allow for units to be re-keyed at a later date if required. Units ship randomly keyed as standard.

cord management

Route power and data cables away from the worksurface through inherent grommet placement. Black grommets are standard in back panels of assembled returns, bridge units, kneespace credenzas, and hutch units. A grommet is standard in tops of corner units. Grommets may be ordered in the tops of desks, returns, bridge units, credenzas, and component worksurfaces. See page 12 for all optional grommet locations.

Undersurface tracks are available for additional cord management. Silver grommets are also available. See Accessories.

finish

The multi-step finish process used by Indiana Furniture provides years of lasting beauty. High quality finish materials offer distinctive grain clarity, superior resistance to normal wear, and ease of maintenance.

Finish Options

WOOD VENEER (W) OR LAMINATE (P) TOPS – MUST SPECIFY



Artisan Walnut
AW

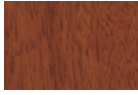

Legacy Walnut
LW



Harvest Walnut
HW



Mahogany on Walnut
MW



Columbian Walnut
CO



Presidential Walnut
PW



Espresso Walnut
EW

Available in High Pressure Laminate Tops. (P)

Edge Options

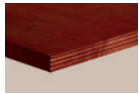

Flute
X

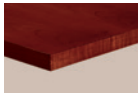

Square
Y

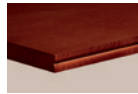

Tail
Z

Pull Options



Aluminum Orbit
AOR



Nickel Bow Tie
NBT



Nickel Comet
NCT



Nickel Quadra
NQD



Finger Pull
FP



Black Orbit
BOR



Black Bow Tie
BBT



Black Comet
BCT



Black Quadra
BQD

INTERIOR DRAWER DIMENSIONS

ALLEGIANCE 1100 INTERIOR DRAWER DIMENSIONS

Item	Drawers	W	L	D
11-3672BDP	Box	12 1/8	16 3/16	3 1/2
11-3672BLP	File	12 1/8	16 3/16	9 5/16
11-3672BRP				
11-3672DP				
11-3672LP				
11-3672RP				
11-3072DP				
11-3072LP				
11-3072RP				
11-3066DP				
11-3066LP				
11-3066RP				
11-3060DP				
11-2448LF2	File	12 1/8	16 3/16	9 5/16
11-2448RF2				
11-2442LF2				
11-2442RF2				
11-2472SC				
11-2472KC				
11-2472RC2				
11-2472LC2				
11-2466KC				
11-2466RC2				
11-2466LC2				
11-2448LF1	Box	12 1/8	16 3/16	3 1/2
11-2448RF1	File	12 1/8	16 3/16	9 5/16
11-2442LF1				
11-2442RF1				
11-2472RC1				
11-2472LC1				
11-2466RC1				
11-2466LC1				
11-2472RL	File	31 1/2	15 1/16	9 7/32
11-2472LL				
11-2436L2				
11-2436L4				
11-1622CD	Center	18 15/16	14 15/16	1 3/4

FILING CAPABILITIES

12 1/8 x 16 13/16

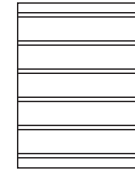

Letter Front to Back

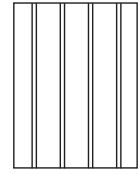

Legal Side to Side

31 1/2 x 15 1/16

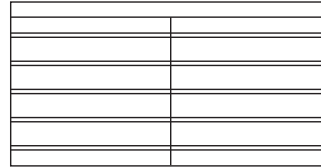

2 Rows Letter or Legal Front to Back

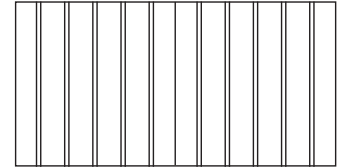

1 Row Letter or Legal Side to Side

GROMMET LOCATIONS

Add upcharge of \$48 list for each grommet.

Specify grommet locations.

- GL - Grommet Left
- GC - Grommet Center
- GR - Grommet Right

Example: 11-3672LP-GL-GR (Grommet Left, Grommet Right)

Grommets may be ordered in non-standard locations. Please call Customer Service to assist with how to order and additional lead time requirements.

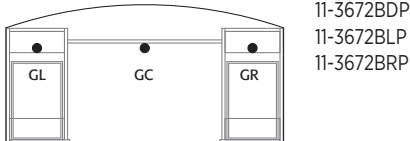

11-3672BDP
 11-3672BLP
 11-3672BRP

GL/GR - 6" from ends, 24 3/4" from user side.
 GC - 24 3/4" from user side.

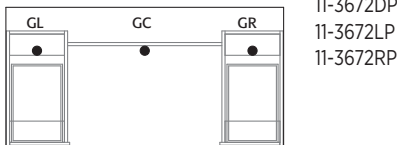

11-3672DP
 11-3672LP
 11-3672RP

GL/GR - 6" from ends, 24 3/4" from user side.
 GC - 24 3/4" from user side.

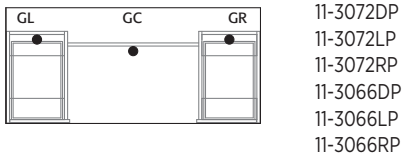

11-3072DP
 11-3072LP
 11-3072RP
 11-3066DP
 11-3066LP
 11-3066RP

GL/GR - 6" from ends, 21 1/2" from user side.
 GC - 18 1/2" from user side.

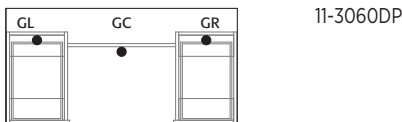

11-3060DP

GL/GR - 6" from ends, 21 1/2" from user side.
 GC - 18 1/2" from user side.

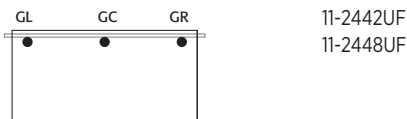

11-2442UF
 11-2448UF

GL/GR - 6" from ends, 20" from user side.
 GC - 20" from user side.

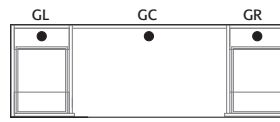
GROMMET LOCATIONS - CONTINUED

11-2472KC
 11-2472LC2
 11-2472RC2
 11-2466KC
 11-2466LC2
 11-2466RC2

11-2472LC1
 11-2472RC1
 11-2466LC1
 11-2466RC1

GL/GR - 6" from ends, 20" from user side.
 GC - 21" from user side.

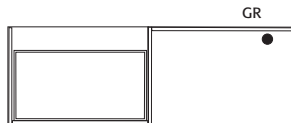

11-2472LL

GR - 6" from end, 20" from user side.

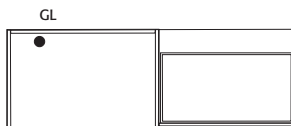

11-2472RL

GL - 6" from end, 20" from user side.

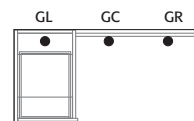

11-2448LF2
 11-2448RF2
 11-2442LF2
 11-2442RF2

11-2448LF1
 11-2448RF1
 11-2442LF1
 11-2442RF1

GL/GR - 6" from ends, 20" from user side.
 GC - 20" from user side.

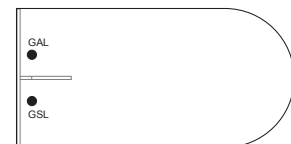

11-3672DUR

GAL/GSL - 6" from ends, 12" from approach/seated side.

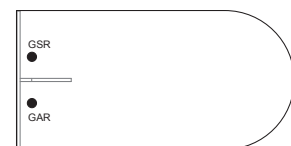

11-3672DUL

GAR/GSR - 6" from ends, 12" from approach/seated side.

LOCKING HUTCH DOORS

Locking doors are available on hutches. Please specify with locking and add \$71 list to the following units.

11-1572HU
 11-1566HU

Please specify with locking and add \$58 list to the following units.

11-1536WD

Item	Model No.	W	D	H	K	R	Ship Wt	Cubic Ft	List Price
EXECUTIVE DOUBLE PED DESK BOW TOP	11-3672BDP	72	36-30	30	40	6	272	51.7	P \$ 2577 W \$ 2829

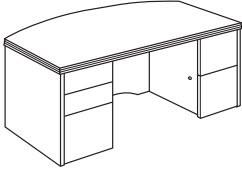

Description

- Bow Top
- Stepped Front
- Arched Modesty Panel
- Locking Pedestals - Top Left Box Drawer Non-Locking
- Letter Width Pedestals
- Box/Box/File in Left Pedestal
- File/File in Right Pedestal

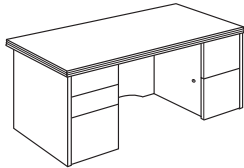
EXECUTIVE DOUBLE PED DESK RECTANGULAR TOP	11-3672DP	72	36	30	40	6	271	51.7	P \$ 2249 W \$ 2592
	11-3072DP	72	30	30	40	6	286	43.9	P \$ 2233 W \$ 2567
	11-3066DP	66	30	30	34	6	240	38.7	P \$ 2209 W \$ 2532
	11-3060DP	60	30	30	28	6	225	35.3	P \$ 2146 W \$ 2463

Description

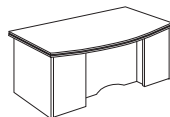
- Rectangular Top
- Stepped Front
- Arched Modesty Panel
- Locking Pedestals - Top Left Box Drawer Non-Locking
- Letter Width Pedestals
- Box/Box/File in Left Pedestal
- File/File in Right Pedestal



Approach View

For ordering options, see back of Allegiance Identification card at the beginning of section.

For grommet options, see page 12.

For center drawer options, see page 24.

Item	Model No.	W	D	H	K	R	Ship Wt	Cubic Ft	List Price	
EXECUTIVE SINGLE PED DESK BOW TOP	Left Ped									
	Right Ped									
	11-3672BLP	11-3672BRP	72	36-30	30	32	6	226	52.3	P \$ 2298 W \$ 2550

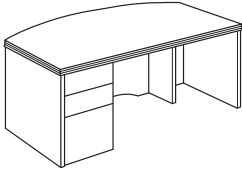
Description

- Bow Top
- Stepped Front
- Arched Modesty Panel
- Locking Pedestal - Top Drawer Non-Locking
- Letter Width Pedestal
- Box/Box/File in Pedestal

EXECUTIVE SINGLE PED DESK RECTANGULAR TOP	Left Ped	Right Ped								
	11-3672LP	11-3672RP	72	36	30	32	6	224	50.0	P \$ 1907 W \$ 2254
	11-3072LP	11-3072RP	72	30	30	32	6	209	43.9	P \$ 1893 W \$ 2226
	11-3066LP	11-3066RP	66	30	30	26	6	193	40.6	P \$ 1867 W \$ 2190

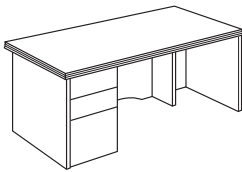
Description

- Rectangular Top
- Stepped Front
- Arched Modesty Panel
- Locking Pedestal - Top Drawer Non-Locking
- Letter Width Pedestal
- Box/Box/File in Pedestal

All pedestal desks shown as left.

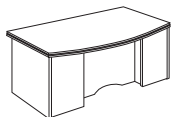

Approach View

For ordering options, see back of Allegiance Identification card at the beginning of section.

For grommet options, see page 12.

For center drawer options, see page 24.

Item	Model No.	W	D	H	K	R	Ship Wt	Cubic Ft	List Price
D-TOP	Left	Right							
	11-3672DUL	11-3672DUR	72	36	30	-	-	133	50.0

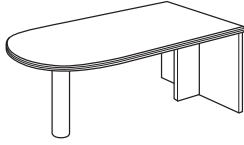
Description

- End Support
- Metal 4 1/2" Cylinder Base. Must specify: Black or Aluminum
- Not Recommended for Freestanding Applications

Options: Specify & Add

11-HMD	Optional Half Modesty Panel	\$ 142
11-FMD	Optional Full Modesty Panel	\$ 214

For ordering options, see back of Allegiance Identification card at the beginning of section.

For grommet options, see page 12.

For center drawer options, see page 24.

Item	Model No.	W	D	H	K	R	Ship Wt	Cubic Ft	List Price	
EXECUTIVE RETURN FILE/FILE	Left Ped	Right Ped								
	11-2448LF2	11-2448RF2	48	24	30	32	1	136	25.0	P \$ 1476 W \$ 1526
	11-2442LF2	11-2442RF2	42	24	30	26	1	126	22.6	P \$ 1397 W \$ 1440

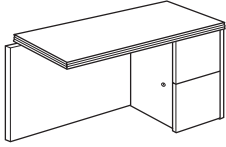
Description

- Locking File Drawers
- Letter Width Pedestal
- File/File in Pedestal
- Grommet in Back Panel
- Grain Direction Runs Front to Back on Worksurface

Item	Model No.	W	D	H	K	R	Ship Wt	Cubic Ft	List Price	
EXECUTIVE RETURN BOX/BOX/FILE	Left Ped	Right Ped								
	11-2448LF1	11-2448RF1	48	24	30	32	1	140	23.1	P \$ 1476 W \$ 1526
	11-2442LF1	11-2442RF1	42	24	30	26	1	126	22.6	P \$ 1397 W \$ 1440

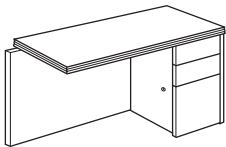
Description

- Locking Pedestal - Top Box Drawer Non-Locking
- Letter Width Pedestal
- Box/Box/File in Pedestal
- Grommet in Back Panel
- Grain Direction Runs Front to Back on Worksurface

All returns shown as right.

For ordering options, see back of Allegiance Identification card at the beginning of section.

For grommet options, see page 12.

For center drawer options, see page 24.

Item	Model No.	W	D	H	K	R	Ship Wt	Cubic Ft	List Price
EXECUTIVE BRIDGE FULL MODESTY	11-2448UF	48	24	30	48	-	84	6.4	P \$ 800 W \$ 850
	11-2442UF	42	24	30	42	-	76	6.4	P \$ 776 W \$ 819

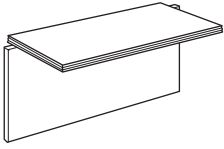
Description

- Grain Direction Runs Front to Back on Worksurface
- Hinged Back Panel

NOTE: Keyboards and center drawers can not be factory installed.

EXECUTIVE BRIDGE HALF MODESTY	11-2448UFH	48	24	11	48	-	64	5.3	P \$ 778 W \$ 828
	11-2442UFH	42	24	11	42	-	56	4.7	P \$ 756 W \$ 801

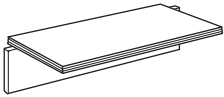
Description

- Grain Direction Runs Front to Back on Worksurface
- Hinged Back Panel

NOTE: Keyboards and center drawers can not be factory installed.

CORNER UNIT	11-4242CU	42	42	30	25 1/2	-	152	34.5	P \$ 1364 W \$ 1684
	11-3636CU	36	36	30	17	-	102	25.7	P \$ 1262 W \$ 1534

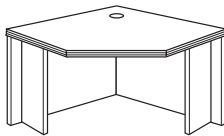
Description

- Free Standing Support Unit
- Connects to 24" Deep Bridge and Return Units
- Grommet in Top
- Grain Direction Runs Front to Back on Veneer Worksurfaces
- Grain Direction Runs with the Long Edge on HPL Worksurfaces

NOTE: Not all keyboards will fit the 11-3636CU. Recommended keyboards are 1-KCWR, 1-KCPR, and 1-KC.

For ordering options, see back of Allegiance Identification card at the beginning of section.

For grommet options, see page 12.

Item	Model No.	W	D	H	K	R	Ship Wt	Cubic Ft	List Price	
EXECUTIVE CREDENZA FILE/FILE	Left Ped	Right Ped								
	11-2472LC2	11-2472RC2	72	24	30	32	-	189	34.2	P \$ 1674 W \$ 2002
	11-2466LC2	11-2466RC2	66	24	30	26	-	177	31.5	P \$ 1659 W \$ 1974

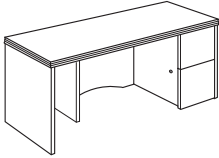
Description

- Arched Modesty Panel
- Locking Pedestal
- File/File in Pedestal
- Grommet in Back Panel

Item	Model No.	W	D	H	K	R	Ship Wt	Cubic Ft	List Price	
EXECUTIVE CREDENZA BOX/BOX/FILE	Left Ped	Right Ped								
	11-2472LC1	11-2472RC1	72	24	30	32	-	189	34.2	P \$ 1674 W \$ 2002
	11-2466LC1	11-2466RC1	66	24	30	26	-	177	31.5	P \$ 1659 W \$ 1972

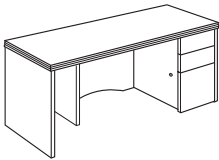
Description

- Arched Modesty Panel
- Locking Pedestal - Top Box Drawer Non-Locking
- Letter Width Pedestal
- Box/Box/File in Pedestal
- Grommet in Back Panel

Item	Model No.	W	D	H	K	R	Ship Wt	Cubic Ft	List Price	
EXECUTIVE CREDENZA LATERAL/LATERAL	Left Ped	Right Ped								
	11-2472LL	11-2472RL	72	24	30	12 3/8	-	228	35.6	P \$ 1946 W \$ 2272

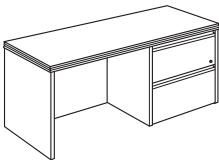
Description

- Locking
- Lateral/Lateral in Pedestal
- Grommet in Back Panel

All credenzas shown as right.

For ordering options, see back of Allegiance Identification card at the beginning of section.

For grommet options, see page 12.

Item	Model No.	W	D	H	K	R	Ship Wt	Cubic Ft	List Price
TRANSACTION RISER FOR DESKS/CREDENZAS	11-1272TR For Use with 72" Worksurfaces	72	12	13	-	-	60	9.0	P \$ 849 W \$ 862
	11-1266TR For Use with 66" Worksurfaces	66	12	13	-	-	54	8.9	P \$ 806 W \$ 819

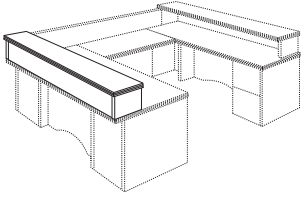
Description

- Freestanding Riser for Desks or Credenzas
- May Be Used in Conjunction with Return Risers or Bridge Risers

TRANSACTION RISER FOR RETURNS	Left Ped	Right Ped	W	D	H	K	R	Ship Wt	Cubic Ft	List Price
	11-1272LU For Use with 36" or 30" Desks and 48" Returns	11-1272RU		74	11 3/4	12	-	-	37	9.7

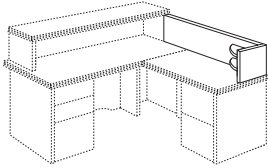
Description

- Must Be Used in Conjunction with a Desk Riser
- Grain Direction Runs Front to Back on Worksurface
- Telescoping Back Panel Attaches Inside Desk Riser

TRANSACTION RISER FOR BRIDGES	11-1288BP For Use with 36" or 30" Desks and 48" Bridge	88	3/4	12	-	-	24	3.6	W \$ 554
----------------------------------	---	----	-----	----	---	---	----	-----	----------

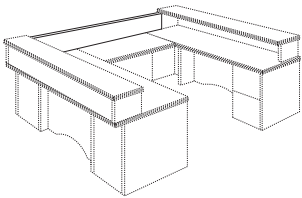
Description

- Must Be Used in Conjunction with Two Desk/Credenza Risers
- Grain Direction Runs Front to Back on Worksurface
- Telescoping Back Panel Attaches Inside Desk & Credenza Risers

For ordering options, see back of Allegiance Identification card at the beginning of section.

Item	Model No.	W	D	H	K	R	Ship Wt	Cubic Ft	List Price
STORAGE CREDENZA FULL PEDESTAL	11-2472SC	72	24	30	-	-	281	34.2	P \$ 2862 W \$ 3189

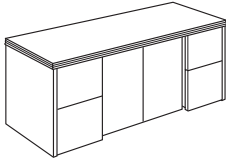
Description

- Recessed Doors
- Pedestals Lock Behind Doors
- Letter Width Pedestals
- File/File in Pedestals
- Fixed Storage Shelf Behind Doors

KNEESPACE CREDENZA FULL PEDESTAL	11-2472KC	72	24	30	40	-	222	34.2	P \$ 1930 W \$ 2258
	11-2466KC	66	24	30	34	-	217	31.5	P \$ 1888 W \$ 2203

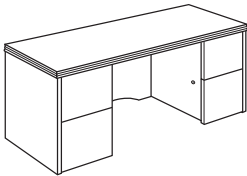
Description

- Arched Modesty Panel
- Locking File Drawers
- Letter Width Pedestals
- File/File in Pedestals
- Grommet in Back Panel

For ordering options, see back of Allegiance Identification card at the beginning of section.

For grommet options, see page 12.

Item	Model No.	W	D	H	K	R	Ship Wt	Cubic Ft	List Price
FOUR DRAWER LATERAL FILE	11-2436L4	35 1/2	24	58	-	-	293	35.6	P \$ 2432 W \$ 2645

Description

- Locking File Drawers
- Anti-Tilt System
- File Drawers Provide Legal or Letter Filing

TWO DRAWER LATERAL FILE	11-2436L2	35 1/2	24	30	-	-	162	18.5	P \$ 1620 W \$ 1830
----------------------------	-----------	--------	----	----	---	---	-----	------	------------------------

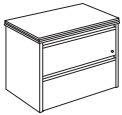
Description

- Locking File Drawers
- Anti-Tilt System
- File Drawers Provide Legal or Letter Filing

MOBILE PEDESTAL	11-1523MP1	16	23	28 1/2	-	-	90	9.0	W \$ 1033
-----------------	------------	----	----	--------	---	---	----	-----	-----------

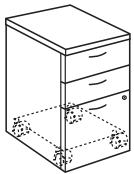
Description

- Locking Pedestal
- Letter Width Pedestal
- Box/Box/File in Pedestal
- Self Edge Top
- Casters Allow for Easy Moving
- Fits Underneath 30" H Worksurfaces

NOTE: Not available with Finger Pull Option.

For ordering options, see back of Allegiance Identification card at the beginning of section.

For grommet options, see page 12.

For center drawer options, see page 24.

Item	Model No.	W	D	H	K	R	Ship Wt	Cubic Ft	List Price
DOOR HUTCH	11-1572HU	72	15	38	-	-	186	30.1	\$ 1734
	11-1566HU	66	15	38	-	-	161	29.3	\$ 1715

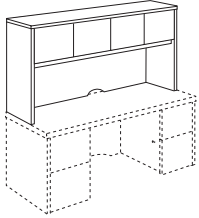
Description

- Storage Behind Doors
- Arched Wire Management in Back Panel
- 21" Clearance Below Doors

OPEN HUTCH	11-1572HN	72	15	38	-	-	173	30.1	\$ 1359
	11-1566HN	66	15	38	-	-	146	29.3	\$ 1337

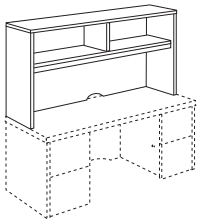
Description

- Open Storage
- Arched Wire Management in Back Panel
- 21" Clearance Below Doors

WOOD DOOR WALL MOUNT HUTCH	11-1536WD	36	15	17 1/8	-	-	60	5.9	\$ 1253
-------------------------------	-----------	----	----	--------	---	---	----	-----	---------

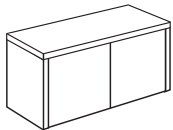
Description

- Mounts to Wall with Mounting Bracket Included

NOTE: Indiana Furniture will not be liable for wall mount hutch units that are not properly installed.

For ordering options, see back of Allegiance Identification card at the beginning of section.

For tackboard and tasklights, see page 27.

Item	Model No.	W	D	H	K	R	Ship Wt	Cubic Ft	List Price
OPEN SHELF WALL MOUNT HUTCH	11-1536WN	36	15	17 1/8	-	-	50	5.9	\$ 1105

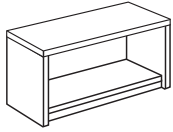
Description

- Mounts to Wall with Mounting Bracket Included

NOTE: Indiana Furniture will not be liable for wall mount hutch units that are not properly installed.

TOP UNIT BOOKCASE	11-1536TU	35 1/4	15	38	-	-	81	15.2	\$ 1058
----------------------	-----------	--------	----	----	---	---	----	------	---------

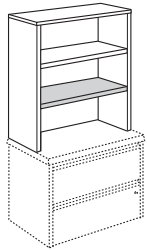
Description

- Fixed Bottom Shelf with 12" Clearance
- One Adjustable Shelf
- For Use on Two Drawer Lateral Files or Credenzas
- Shelves are 1" Thick
- Unfinished Back

NOTE: Recommended for application against a wall.

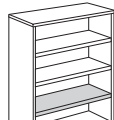
BOOKCASES	Model No.	W	D	H	K	R	Ship Wt	Cubic Ft	List Price
	11-3667BC Three Adjustable Shelves	35 1/4	15	67 5/16	-	-	158	26.6	W \$ 1458
	11-3648BC Two Adjustable Shelves	35 1/4	15	48	-	-	114	20.1	W \$ 1097
	11-3630BC One Adjustable Shelf - Profiled Top	35 1/2	15	29 1/4	-	-	85	11.1	P \$ 1060 W \$ 1072

Description

- 1" Thick Shelves
- Unfinished Back

COMPUTER WORK TABLE	11-2442CW	42	24	30	12	-	101	20.4	P \$ 1160 W \$ 1204
---------------------	-----------	----	----	----	----	---	-----	------	------------------------

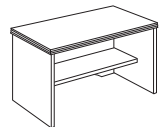

Description

- Arched Modesty Panel
- Fixed Shelf with 16" Clearance
- Grommet in Back Panel

For ordering options, see back of Allegiance Identification card at the beginning of section.

For grommet options, see page 12.

For center drawer options, see page 24.

Item	Model No.	W	D	H	K	R	Ship Wt	Cubic Ft	List Price
CIRCULAR TOP 	11-4242CT Accommodates 4 Chairs	42	42	1	-	-	40	4.4	P \$ 931 W \$ 1196
	11-3636CT Accommodates 3 Chairs	36	36	1	-	-	35	3.4	P \$ 860 W \$ 1096

Description

- 1" Thick Top
- Single Base Required

METAL BASE  Open Market Only	01-0400MBB Black	32	32	27 3/4	-	-	32	3.2	\$ 632
	01-0400MBA Aluminum	32	32	27 3/4	-	-	32	3.2	\$ 632

Description

- Shipped KD - Some Assembly Required
- For use with 42" or 36" Circular Top

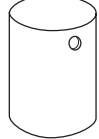
CYLINDER BASE 	01-2020CB For use with 42" Circular Top	20	20	28 1/2	-	-	134	11.1	\$ 977
	01-1616CB For use with 36" Circular Top	16	16	28 1/2	-	-	101	7.2	\$ 892

Description

- Veneer Cylinder Base
- Weighted for Stability
- Wire Management
- 2 Wire Management Grommets Standard at Top with 8" Opening Standard in Bottom

Options: Specify & Add

GCBIS	Optional Grommet Top Edge (1)	\$	N/C
NOGC	Optional No Grommets At Top Edges	\$	N/C

CENTER DRAWER	11-1622CD	22	16	2 3/4	-	-	12	2.0	\$ 299
---------------	-----------	----	----	-------	---	---	----	-----	--------

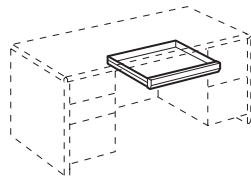

SIN 711-8

Description

- Fits All Desks
- Built in Pen Tray

Options: Specify & Add

Factory Installed	\$	130
-------------------	----	-----

For ordering options, see back of Allegiance Identification card at the beginning of section.

Item	Model No.	W	D	H	K	R	Ship Wt	Cubic Ft	List Price
EXECUTIVE "L" UNIT	11-1	72	84	30	-	-	360	77.3	P \$ 3383 W \$ 3780

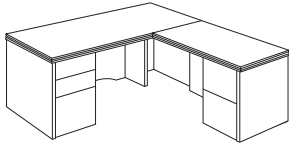
Consists of:
Qty

11-3672LP	1	• Left Pedestal Desk	P \$ 1907 W \$ 2254
11-2448RF2	1	• Executive Right Return	P \$ 1476 W \$ 1526

EXECUTIVE "U" UNIT BOW TOP DESK STEPPED FRONT	11-2	72	108	30	-	-	499	92.9	P \$ 4772 W \$ 5402
---	------	----	-----	----	---	---	-----	------	------------------------

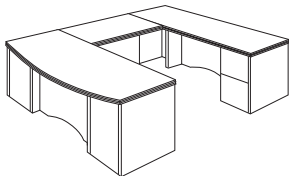
Consists of:
Qty

11-3672BLP	1	• Bow Left Pedestal Desk	P \$ 2298 W \$ 2550
11-2448UF	1	• Bridge	P \$ 800 W \$ 850
11-2472RC2	1	• Executive Single Right Credenza	P \$ 1674 W \$ 2002

All pedestal desks shown as left.
 All returns shown as right.

For ordering options, see back of Allegiance Identification card at the beginning of section.

For grommet options, see page 12.

For center drawer options, see page 24.

Item	Model No.	W	D	H	K	R	Ship Wt	Cubic Ft	List Price
EXECUTIVE "U" UNIT P-TOP	11-3	72	108	30	-	-	406	90.6	P \$ 4030 W \$ 4676

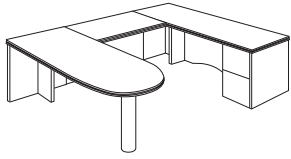
Consists of:
Qty

11-3672DUL	1	• Left D Top Unit	P \$ 1556 W \$ 1824
11-2448UF	1	• Bridge	P \$ 800 W \$ 850
11-2472RC2	1	• Executive Single Right Credenza	P \$ 1674 W \$ 2002

RECEPTION RISER "L" UNIT	11-4	72	84	30	-	-	457	96	P \$ 4896 W \$ 5306
-----------------------------	------	----	----	----	---	---	-----	----	------------------------

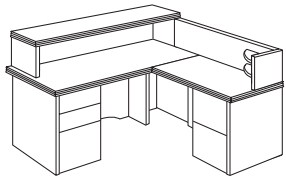
Consists of:
Qty

11-3672LP	1	• Left Single Pedestal Desk	P \$ 1907 W \$ 2254
11-2448RF2	1	• Right Return	P \$ 1476 W \$ 1526
11-1272TR	1	• Desk Riser	P \$ 849 W \$ 862
11-1272RU	1	• Return Riser	\$ 664

For ordering options, see back of Allegiance Identification card at the beginning of section.

For grommet options, see page 12.

For center drawer options, see page 24.

TACKBOARD: SURFACE MOUNTED HUTCHES – 20 1/8" TALL

Size	Model #	COM ydg	COM, Grade 1, 2 or 3 List Price	Grade 4 List Price	Grade 5 List Price	Grade 6 List Price	Grade 7 List Price	Grade 8 List Price	Grade 9 List Price	Grade 10 List Price
66"	TB-1166H	2.00	\$ 336	\$ 518	\$ 600	\$ 690	\$ 810	\$ 937	\$ 1090	\$ 1263
72"	TB-1172H	2.25	\$ 357	\$ 561	\$ 653	\$ 755	\$ 890	\$ 1033	\$ 1204	\$ 1399

TACKBOARD: WALL MOUNTED HUTCHES – 21 7/8" TALL

Size	Model #	COM ydg	COM, Grade 1, 2 or 3 List Price	Grade 4 List Price	Grade 5 List Price	Grade 6 List Price	Grade 7 List Price	Grade 8 List Price	Grade 9 List Price	Grade 10 List Price
36"	TB-0136W	1.25	\$ 274	\$ 387	\$ 438	\$ 495	\$ 570	\$ 649	\$ 744	\$ 853

TASKLIGHTS - Includes 1 Wire Management Grommet

Model #	Size	Description	List Price
TL-0824	22 1/2" x 1 5/8" x 7/8"	84-LED, 7 Watts	\$ 234
TL-0848	47 1/2" x 1 5/8" x 7/8"	240-LED, 18 Watts	\$ 280

CanvasTM

Casegoods Collection

How to Order

MODEL NO.	DESCRIPTION	
68-3672BDP	Chassis	TK
	Top Surface	T
	Top Color	WH
	Profile	F
	Drawer Front	WH
	Pull	AAC

All options must be labeled and specified.



Specifications



LAMINATES

Exposed surfaces are produced from wood grained and solid color laminates fused to a particle-board core. Each laminate offers lasting beauty, superior resistance to normal wear, and easy maintenance. Eight textured laminates are included in the color palette.

TOPS

Tops are 1" thick thermally-fused laminate (TFL) or high pressure laminate using 3mm PVC rims or profiled edges and 1 mm PVC rims on self edges. Grain direction runs left to right unless noted.

CHASSIS CONSTRUCTION

TFL chassis are fastened by screws, glue, and heavy-duty metal fasteners assuring maximum strength. Units ship assembled unless noted. All units ship with leveling glides. All desks, non-lateral credenzas, and returns have wire management access from pedestal to kneespace.

DRAWERS

All drawer fronts are 3-ply construction, 3/4" thick with matched grain. Drawer sides, back, and front are wood grain vinyl wrapped, 1/2" thick. Box and file drawers have 1/8" thick hardboard bottoms. Lateral file drawers feature 1/4" thick bottoms. 5-sided drawer construction allows for easy removal of drawer fronts.

DRAWER SUSPENSIONS

Box and file drawers have full extension, progressive action slides with precision steel ball bearings. All suspensions have a lifetime warranty.

FILING HARDWARE

All file drawers are standard with filing systems designed to accommodate a variety of filing requirements. Letter width file drawers provide letter filing front to back, and letter or legal filing side to side. Lateral file drawers provide legal or letter filing front to back or side to side.

LOCKING

All desks, credenzas, returns, and files feature standard locking. Removable lock cylinders allow for units to be re-keyed at a later date if required. Units ship randomly keyed as standard. Lock cores match pull color.

CORD MANAGEMENT

Route power and data cables away from the worksurface through inherent grommet placement. Grommets may be ordered in the tops of all assembled desks, returns, bridges, credenzas, and component worksurfaces. All desks, returns, and credenzas (except lateral pedestals) have standard wire openings from inside the pedestal to the kneespace allowing quick access to technology below. Additionally, returns, bridge units, kneespace credenzas, and hutch units have standard grommets available in backpanels. Grommets are also standard in the tops of corner units and extended corner units. See page 35 for all optional grommet locations.

Undersurface tracks are available for additional cord management. Silver grommets are also available. See Accessories.

Laminate Options

STANDARD TFL (T) OR HPL (P) TOPS - MUST SPECIFY

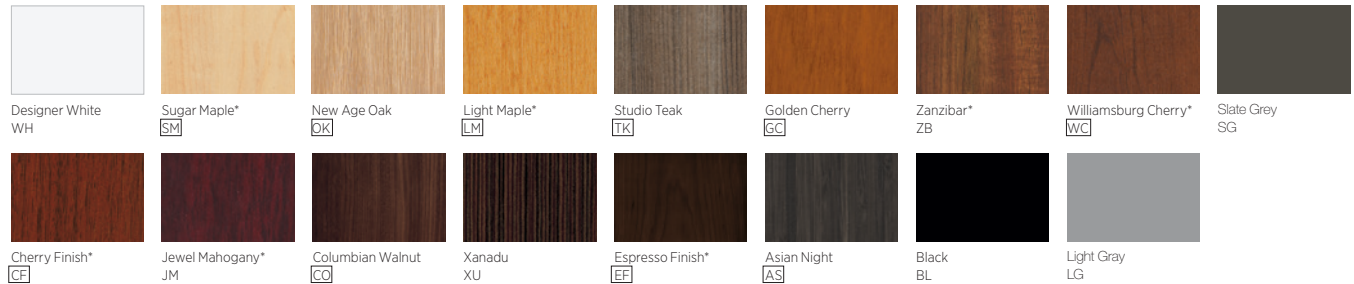

Available in High Pressure Laminate Tops. (P)
 * Not available on laminate framed modesty panels or doors.

TEXTURED TFL - MUST SPECIFY (TXT)



Textured options are available with "H" square edge only.
 Textured laminates are only available up to 96".
 Multi-color units that include textured TFL will be priced as the TXT list price.
 * Not available on laminate framed modesty panels or doors.

METAL FRAME OPTIONS

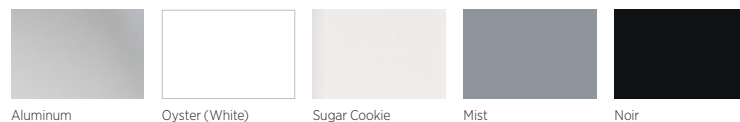

Edge Options



Pull Options

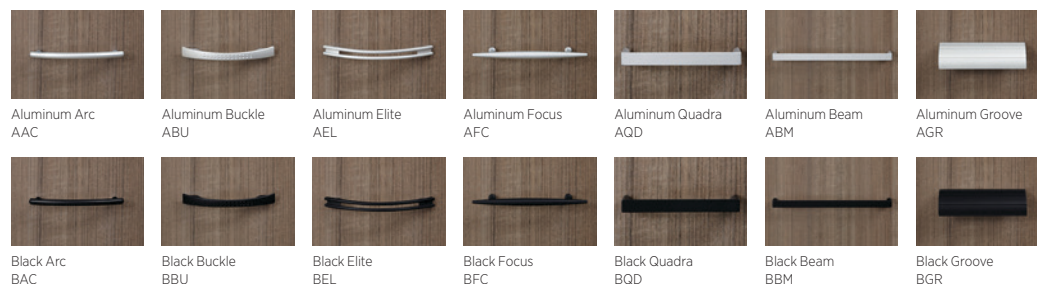

COORDINATING PRODUCTS

Canvas Casegoods offers options to coordinate with Niche Conference.

INTERIOR DRAWER DIMENSIONS

CANVAS 6800 INTERIOR DRAWER DIMENSIONS

Item	Drawers	W	L	D
68-4872CBLP/CBRP	Box	12 1/8	16 3/16	3 1/2
68-4272CLP/CRP	File	12 1/8	16 3/16	9 5/16
68-3672LPS/RPS				
68-3672LP/RP				
68-3672DPS				
68-3672BLPS/BRPS				
68-3672BLP/BRP				
68-3672BDPS				
68-3072LP/RP				
68-3072DP				
68-3066DP				
68-3060DP				
68-4824RF2/LF2	File	12 1/8	16 3/16	9 5/16
68-4224RF2/LF2				
68-2472SC				
68-2472RC2/LC2				
68-2472KC				
68-2466SC				
68-2466RC2/LC2				
68-2466KC				
68-2448RF2/LF2				
68-2442RF2/LF2				
68-4824RF1/LF1	Box	12 1/8	16 3/16	3 1/2
68-4224RF1/LF1	File	12 1/8	16 3/16	9 15/16
68-2472RC1/LC1				
68-2466RC1/LC1				
68-2448RF1/LF1				
68-2442RF1/LF1				

CANVAS 6600 INTERIOR DRAWER DIMENSIONS

Item	Drawers	W	L	D
66-3672LP/RP	Box	12 1/8	16 3/16	3 1/2
66-3672DP	File	12 1/8	16 3/16	9 5/16
66-3672BLP/BRP				
66-3672BDP				
66-3072DP				
66-3066DP				
66-3060DP				
66-2415SHPD2				
66-2515SHPD1				
66-2472SC				
66-2472RC/LC				
66-2472KC				
66-2466SC				
66-2466RC/LC				
66-2466KC				
66-2448RF/LF				
66-2442RF/LF				
66-2415PD1				
66-1519MP				

INTERIOR DRAWER DIMENSIONS

CANVAS 6600 INTERIOR DRAWER DIMENSIONS

Item	Drawers	W	L	D
66-3672WDS2	Lat File	26 9/32	15 1/16	9 7/32
66-3072SU1				
66-2430LF1				
66-3672SU1	Lat File	32 9/32	15 1/16	9 7/32
66-2436LF1				
66-2418LTF	Tray	14 9/32	15 1/16	1 1/8
	File	14 9/32	15 1/16	9 7/32
66-2430LTF	Tray	26 9/32	15 1/16	1 21/32
	Lat File	26 9/32	15 1/16	9 7/32
66-2436LTF	Tray	32 9/32	15 1/16	1 21/32
	Lat File	32 9/32	15 1/16	9 7/32
66-2436OMF	Box	14 9/32	15 1/8	3 1/2
	Lat File	32 9/32	15 1/16	9 7/32
66-2430OMF	Box	11 3/4	16 3/16	3 1/2
	Lat File	26 9/32	15 1/16	9 7/32
66-2472BF	Box	32 1/8	16 3/16	3 1/2
66-2472RMR/LMR	Box	14 9/32	15 1/8	3 1/2
66-2472RMF/LMF	File	14 9/32	15 1/8	9 5/16
66-2436MF	Lat File	32 9/32	15 1/16	9 7/32
66-2436LF2	Box	14 9/32	15 1/8	3 1/2
	File	14 9/32	15 1/8	9 1/4
	Lat File	32 9/32	15 1/16	9 1/4
66-2430LF2	Box	11 23/32	16 3/16	3 1/2
	File	11 23/32	16 3/16	9 1/4
	Lat File	26 9/32	15 1/16	9 1/4
66-2418PD2	File	14 9/32	15 1/8	9 5/16
66-3018PD2				
66-3618PD2				
66-1872WFO				
66-1872WFL/WFR				
66-1872DS2L/DS2R				
66-2418PD1	Box	14 9/32	15 1/8	3 1/2
66-3018PD1	File	14 9/32	15 1/8	9 5/16
66-3618PD1				
66-1872WBO				
66-1872WBL/WBR				
66-1872DS1L/DS1R				
66-2415PD2	File	12 1/8	16 3/16	9 5/16
66-2430L4	Lat File	25 17/32	15 1/16	9 7/32
66-2430L2				
66-2472RL/LL	Lat File	31 1/2	15 1/16	9 7/32
66-2472DL				
66-2436L4				
66-2436L2				
66-1622CD	Center	18 15/16	14 15/16	1 3/4

FILING CAPABILITIES

$11 \frac{23}{32} \times 16 \frac{3}{16}$

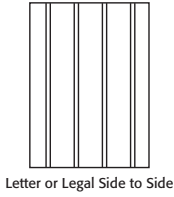

$12 \frac{1}{8} \times 16 \frac{3}{16}$

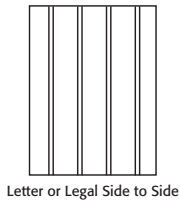

$14 \frac{9}{32} \times 15 \frac{1}{8}$

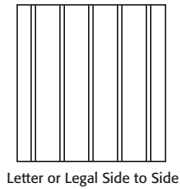
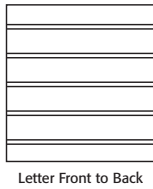

$25 \frac{17}{32} \times 15 \frac{1}{16}$

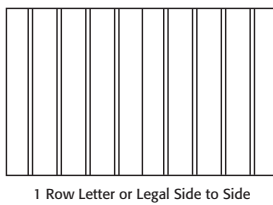
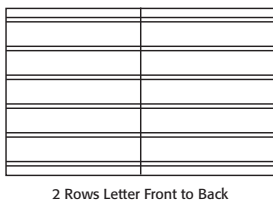

FILING CAPABILITIES

$26 \frac{9}{32} \times 15 \frac{1}{16}$

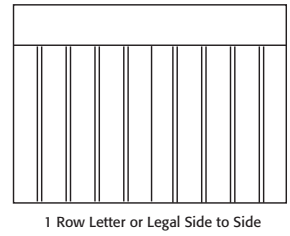
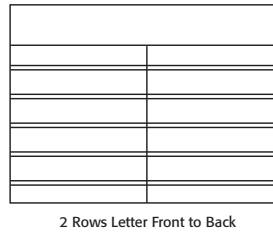

$31 \frac{1}{2} \times 15 \frac{1}{16}$

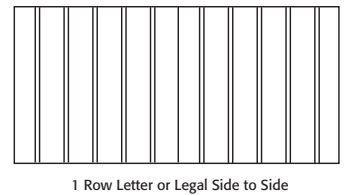
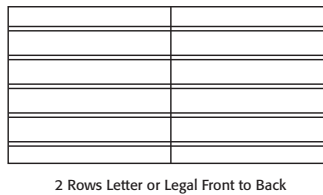

$32 \frac{9}{32} \times 15 \frac{1}{16}$

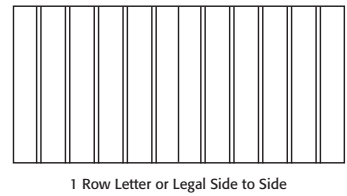
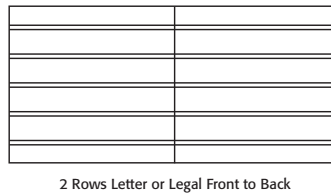

GROMMET LOCATIONS

Grommets are standard in the back panels of returns, bridges, and credenzas. These units may be ordered without grommets at no additional charge. Please specify "NO GROMMET" on order.

Grommets are available on hutches in standard locations for tasklight management at no additional charge. Please specify HUGRMT.

Desk grommets are available in standard locations. Please specify and add an upcharge of \$48 list for each grommet.

Specify grommet locations.

- GL - Grommet Left
- GC - Grommet Center
- GR - Grommet Right

Example: 66-3672DP-GL-GR (Grommet Left, Grommet Right)

Grommets may be ordered in non-standard locations. Please call Customer Service to assist with how to order and additional lead time requirements.

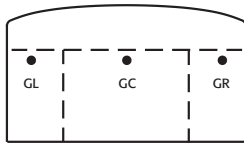

- 68-4872CBLP/CBRP
- 68-3672BDP
- 68-3672BLPS/BRPS
- 68-3672BDPS
- 68-3672BLP/BRP
- 66-3672BDP
- 66-3672BLP/BRP

GL/GR - 6" from ends, 22 1/2" from user side.
 GC - 22 1/2" from user side.

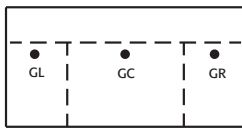

- 68-4272CLP/CRP
- 68-3672DPS
- 68-3672LPS/RPS
- 68-3672LP/RP
- 66-3672TP
- 66-3672DP
- 66-3672LP/RP
- 66-3672SH

GL/GR - 6" from ends, 22 1/2" from user side.
 GC - 22 1/2" from user side.

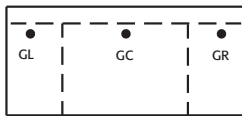

- 68-3072DP
- 68-3066DP
- 68-3060DP
- 68-3072LP/RP
- 68-3066LP/RP
- 66-3072DP
- 66-3066DP
- 66-3060DP
- 66-3072LP/RP
- 66-3066LP/RP
- 66-3072TP
- 66-3066TP
- 66-3060TP

GL/GR - 6" from ends, 22 1/2" from user side.
 GC - 22 1/2" from user side.

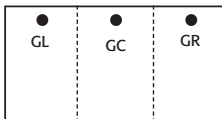

- 68-2448LF1/RF1
- 68-2448LF2/RF2
- 68-2442LF1/RF1
- 68-2442LF2/RF2
- 66-2448LF/RF
- 66-2442LF/RF
- 66-2448UF/UFH
- 66-2442UF/UFH

GL/GR - 6" from ends, 20" from user side.
 GC - 20" from user side.



- 66-2472LMR/RMR
- 66-2472LL/RL
- 66-2472RMF/LMF
- 66-2466LL/RL
- 66-2466RMF/LMF

GL/GR - 6" from ends, 20" from user side.

GROMMET LOCATIONS - CONTINUED

- 68-2472KC
- 68-2472LC1/RC1
- 68-2472LC2/RC2
- 66-2472KC
- 66-2472LC/RC
- 66-2472SH
- 68-2466KC
- 68-2466LC1/RC1
- 68-2466LC2/RC2
- 66-2466KC
- 66-2466LC/RC

All 24" Modular Tops, See Page 75

GL/GR - 6" from ends, 20" from user side.
 GC - 20" from user side.

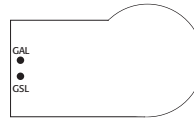

- 66-4284PR
- 66-4284TR
- 66-4272PR
- 66-4272TR



- 66-4284PL
- 66-4284TL
- 66-4272PL
- 66-4272TL

GAL/GSL - 12" from approach or seated side, 6" from end.
 GAR/GSR - 12" from approach or seated side, 6" from end.



- 66-4272EDR

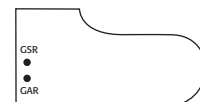

- 66-4272EDL

GAL/GAR - 12" from approach, 6" from end.
 GSL/GSR - 24" from approach, 6" from end.



- 66-3684DUR
- 66-3672DUR
- 66-3072DUR
- 66-3066DUR



- 66-3684DUL
- 66-3672DUL
- 66-3684DR
- 66-3672DR
- 66-3072DUL
- 66-3066DUL
- 66-3066DR

GAL/GSL - 12" from approach or seated side, 6" from end.
 GAR/GSR - 12" from approach or seated side, 6" from end.

LOCKING HUTCH DOORS

Locking doors are available on solid panel hinged doors.

Size		List Upcharge
30" - 42"	=	\$58.00
48" - 78"	=	\$71.00
84" - 108"	=	\$84.00

Sit-To-Stand Mechanisms

Electric powered sit-to-stand mechanisms are offered on select units as noted. Sit-to-stand mechanisms come factory installed and must be specified at the time of order.

Please note, optional modesty panels and kneespace options are not available with the sit-to-stand mechanism.

2 year warranty. Add 100 lbs. to shipping weight.

Description

- Maximum height is 42"
- Load capacity is recommended at a safe 50 lbs; weight distribution is key to capacity
- Safety stop at 2" above the work surface prevents pinches
- Sit-to-stand mechanisms reduce the kneespace depth by 9.5"
- Bridges, returns and credenzas will not have a standard grommet on back panel
- Grommet not an option without vertebrae or box

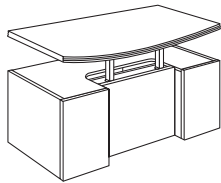

Sit-to-Stand

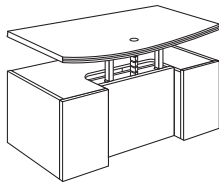

Sit-to-Stand w/Vertebrae

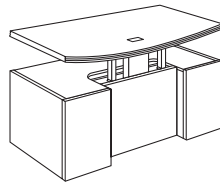

Sit-to-Stand w/Box

Specify & Add

STS Sit-To-Stand	\$ 3528
------------------	---------

Options:

01-BLUETOOTHSWITCH	Blue-Tooth	\$ 52
01-MEMORYSWITCH	Programmable Control	\$ 86

Wire Management and Data

- One data or wire management location per unit
- Order the port and specify the location from chart below

Locations	Grommet w/Vertebrae \$182 List	Grommet w/Box \$323 List	DPORT4 w/Box \$1014 List	Duo Bezel w/Box \$764 List	Trio Bezel w/Box \$795 List
≥66" Desks/Credenzas	Left/Right/Center	Center	Center	Center	Center
60" Desks	Left/Right/Center	-	-	-	-
Returns	Over Ped/Center	-	-	-	-
Bridges	Center	Center	Center	Center	Center

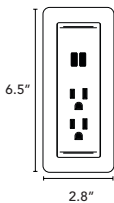

01-DUOBEZELB - Black
01-DUOBEZELW - White
01-DUOBEZELS - Silver
 2 AC outlets
 1 dual 2.1 amp USB port

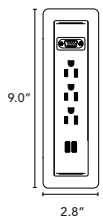

01-TRIOBEZELB - Black
01-TRIOBEZELW - White
01-TRIOBEZELS - Silver
 3 AC outlets
 1 dual 2.1 amp USB port
 1 open space
Optional:
 01-LCOMVGA \$77
 01-LCOMHDMI \$104
 01-LCOMRJ45 \$49

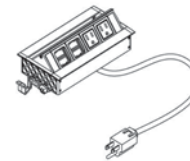

01-DPORT4B - Black
01-DPORT4A - Aluminum

2 AC outlets
 2 open ports

Optional:
 01-USBPORT \$102
 01-VOICE1 \$46
 01-RJ4DATA \$105

NOTE: 01-LCOMHDMI Is Open Market Only

Item	Model No.	W	D	H	K	R	Ship Wt	Cubic Ft	List Price
EXECUTIVE DOUBLE PED DESK BOW TOP	68-3672BDPS	72	36-30	30	40 1/2	-	410	50.0	T\$ 2242
									P\$ 2444
									TXT\$ 2803

Description

- Bow Top
- Stepped Front
- Letter Width Locking Pedestals
- Full Modesty Standard Available in Optional Colors
- Box/Box/File in Left Pedestal; File/File in Right Pedestal
- Wire Management from Pedestal to Kneespace
- Black Utility Tray for Box Drawer
- Sit-to-Stand Option Available, See Page 36

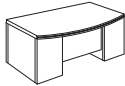
Options: Specify & Add

66-TMD	Optional Laminate 3/4 Modesty Panel	Included
--------	-------------------------------------	----------

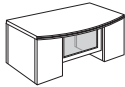

66-TMF	Optional Laminate Framed Acrylic 3/4 Modesty Panel in Select Colors	\$ 214
--------	---	--------

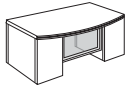

66-TSC	Optional Silver Framed Acrylic 3/4 Modesty Panel	\$ 344
--------	--	--------

EXECUTIVE DOUBLE PED DESK RECTANGULAR TOP	68-3672DPS	72	36	30	40 1/2	-	425	50.0	T\$ 2423
									P\$ 2619
									TXT\$ 2975

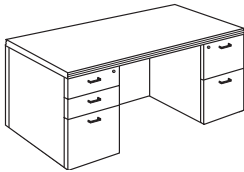
Description

- Stepped Front
- Letter Width Locking Pedestals
- Full Modesty Standard Available in Optional Colors
- Box/Box/File in Left Pedestal; File/File in Right Pedestal
- Wire Management from Pedestal to Kneespace
- Black Utility Tray for Box Drawer
- Sit-to-Stand Option Available, See Page 36

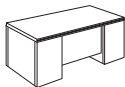
Options: Specify & Add

66-TMD	Optional Laminate 3/4 Modesty Panel	Included
--------	-------------------------------------	----------

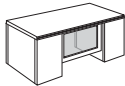

66-TMF	Optional Laminate Framed Acrylic 3/4 Modesty Panel in Select Colors	\$ 214
--------	---	--------

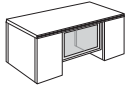

66-TSC	Optional Silver Framed Acrylic 3/4 Modesty Panel	\$ 344
--------	--	--------

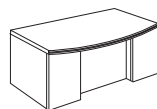

Stepped Front

For ordering options, see back of Canvas Identification card at the beginning of section.

For grommet options, see page 35.

For center drawer options, see page 73.

Item	Model No.	W	D	H	K	R	Ship Wt	Cubic Ft	List Price	
EXECUTIVE DOUBLE PED DESK BOW TOP	68-3672BDP	72	36-30	30	40 1/2	9-3	410	50.0	T\$	2153
									P\$	2353
									TXT\$	2691



Description

- Bow Top
- Recessed Front
- Letter Width Locking Pedestals
- Box/Box/File in Left Pedestal; File/File in Right Pedestal
- Wire Management from Pedestal to Kneespace
- Black Utility Tray for Box Drawer
- Sit-to-Stand Option Available, See Page 36

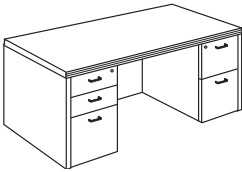
EXECUTIVE DOUBLE PED DESK RECTANGULAR TOP	68-3672DP	72	36	30	40 1/2	9	425	50.0	T\$	1878
									P\$	2074
									TXT\$	2347
68-3072DP	72	30	30	40 1/2	3	410	43.9	T\$	1813	
								P\$	1995	
								TXT\$	2267	
68-3066DP	66	30	30	34 1/2	3	390	38.7	T\$	1747	
								P\$	1924	
								TXT\$	2185	
68-3060DP	60	30	30	28 1/2	3	358	35.3	T\$	1671	
								P\$	1835	
								TXT\$	2089	

Description

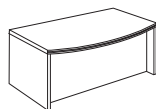
- Recessed Front
- Letter Width Locking Pedestals
- Box/Box/File in Left Pedestal; File/File in Right Pedestal
- Wire Management from Pedestal to Kneespace
- Black Utility Tray for Box Drawer
- Sit-to-Stand Option Available, See Page 36



Recessed Front

For ordering options, see back of Canvas Identification card at the beginning of section.

For grommet options, see page 35.

For center drawer options, see page 73.

Item	Model No.	W	D	H	K	R	Ship Wt	Cubic Ft	List Price
EXECUTIVE DOUBLE 3/4 PED DESK BOW TOP	66-3672BDP	72	36-30	30	40 1/2	9-3	360	50.0	T\$ 1975
									P\$ 2175
									TXT\$ 2469



Description

- Bow Top
- Recessed Front
- Letter Width Locking Pedestals
- Box/File in Pedestals
- Wire Management from Pedestal to Kneespace
- Black Utility Tray for Box Drawer

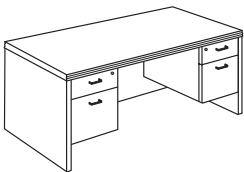
EXECUTIVE DOUBLE 3/4 PED DESK RECTANGULAR TOP	66-3672DP	72	36	30	40 1/2	9	375	50.0	T\$ 1676
									P\$ 1873
									TXT\$ 2096
	66-3072DP	72	30	30	40 1/2	3	360	43.9	T\$ 1588
									P\$ 1770
									TXT\$ 1985
	66-3066DP	66	30	30	34 1/2	3	340	38.7	T\$ 1551
									P\$ 1728
									TXT\$ 1939
	66-3060DP	60	30	30	28 1/2	3	308	35.3	T\$ 1503
									P\$ 1665
									TXT\$ 1879

Description

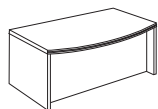
- Recessed Front
- Letter Width Locking Pedestals
- Box/File in Pedestals
- Wire Management from Pedestal to Kneespace
- Black Utility Tray for Box Drawer



Recessed Front

For ordering options, see back of Canvas Identification card at the beginning of section.

For grommet options, see page 35.

For center drawer options, see page 73.

Item	Model No.	W	D	H	K	R	Ship Wt	Cubic Ft	List Price	
EXECUTIVE SINGLE FULL PED DESK BOW TOP	Left Ped	Right Ped								
	68-3672BLPS	68-3672BRPS	72	36-30	30	32 1/4	9-3	320	50.0	T\$ 2013 P\$ 2213 TXT\$ 2516

Description

- Bow Top
- Stepped Front
- Letter Width Locking Pedestal
- Full Modesty Standard Available in Optional Colors
- Box/Box/File in Pedestal
- Wire Management from Pedestal to Kneespace
- Black Utility Tray for Box Drawer
- Sit-to-Stand Option Available, See Page 36

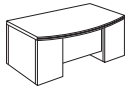
Options: Specify & Add

66-TMD	Optional Laminate 3/4 Modesty Panel	Included
--------	-------------------------------------	----------

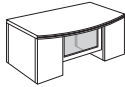

66-TMF	Optional Laminate Framed Acrylic 3/4 Modesty Panel in Select Colors	\$ 214
--------	---	--------

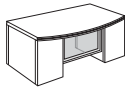

66-TSC	Optional Silver Framed Acrylic 3/4 Modesty Panel	\$ 344
--------	--	--------

Item	Left Ped	Right Ped	W	D	H	K	R	Ship Wt	Cubic Ft	List Price
EXECUTIVE SINGLE FULL PED DESK RECTANGULAR TOP	68-3672LPS	68-3672RPS	72	36	30	32 1/4	-	330	50.0	T\$ 1744 P\$ 1941 TXT\$ 2181

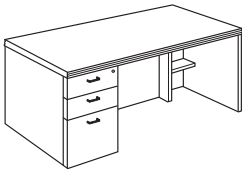
Description

- Stepped Front
- Letter Width Locking Pedestal
- Full Modesty Standard Available in Optional Colors
- Box/Box/File in Pedestal
- Wire Management from Pedestal to Kneespace
- Black Utility Tray for Box Drawer
- Sit-to-Stand Option Available, See Page 36

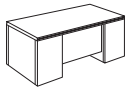
Options: Specify & Add

66-TMD	Optional Laminate 3/4 Modesty Panel	Included
--------	-------------------------------------	----------

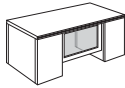

66-TMF	Optional Laminate Framed Acrylic 3/4 Modesty Panel in Select Colors	\$ 214
--------	---	--------

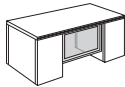

66-TSC	Optional Silver Framed Acrylic 3/4 Modesty Panel	\$ 344
--------	--	--------

All pedestal desks shown as left.

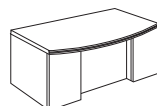

Stepped Front

For ordering options, see back of Canvas Identification card at the beginning of section.

For grommet options, see page 35.

For center drawer options, see page 73.

Item	Model No.	W	D	H	K	R	Ship Wt	Cubic Ft	List Price	
EXECUTIVE SINGLE FULL PED DESK BOW TOP	Left Ped	Right Ped								
	68-3672BLP	68-3672BRP	72	36-30	30	32 1/4	9-3	320	50.0	T\$ 1897
										P\$ 2097
										TXT\$ 2372

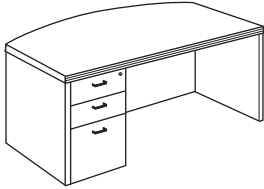
Description

- Bow Top
- Recessed Front
- Letter Width Locking Pedestal
- Box/Box/File in Pedestal
- Wire Management from Pedestal to Kneespace
- Black Utility Tray for Box Drawer
- Sit-to-Stand Option Available, See Page 36

Item	Model No.	W	D	H	K	R	Ship Wt	Cubic Ft	List Price	
EXECUTIVE SINGLE FULL PED DESK RECTANGULAR TOP	Left Ped	Right Ped								
	68-3672LP	68-3672RP	72	36	30	32 1/4	9	330	50.0	T\$ 1596
										P\$ 1793
										TXT\$ 1995
	68-3072LP	68-3072RP	72	30	30	32 1/4	3	210	43.0	T\$ 1573
										P\$ 1757
										TXT\$ 1966
	68-3066LP	68-3066RP	66	30	30	26 1/4	3	160	38.7	T\$ 1509
										P\$ 1684
										TXT\$ 1885

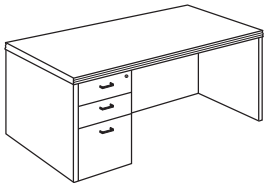
Description

- Recessed Front
- Letter Width Locking Pedestal
- Box/Box/File in Pedestal
- Wire Management from Pedestal to Kneespace
- Black Utility Tray for Box Drawer
- Sit-to-Stand Option Available, See Page 36

All pedestal desks shown as left.



Recessed Front

For ordering options, see back of Canvas Identification card at the beginning of section.

For grommet options, see page 35.

For center drawer options, see page 73.

Item	Model No.	W	D	H	K	R	Ship Wt	Cubic Ft	List Price	
EXECUTIVE SINGLE 3/4 PED DESK BOW TOP	Left Ped	Right Ped								
	66-3672BLP	66-3672BRP	72	36-30	30	32 1/4	9-3	305	50.0	T\$ 1680
										P\$ 1880 TXT\$ 2099

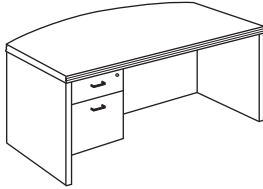
Description

- Bow Top
- Recessed Front
- Letter Width Locking Pedestal
- Box/File in Pedestal
- Wire Management from Pedestal to Kneespace
- Black Utility Tray for Box Drawer

Item	Model No.	W	D	H	K	R	Ship Wt	Cubic Ft	List Price	
EXECUTIVE SINGLE 3/4 PED DESK RECTANGULAR TOP	Left Ped	Right Ped								
	66-3672LP	66-3672RP	72	36	30	32 1/4	9	305	50.0	T\$ 1397
										P\$ 1593 TXT\$ 1746
	66-3072LP	66-3072RP	72	30	30	32 1/4	3	180	43.0	T\$ 1347
										P\$ 1530 TXT\$ 1684
	66-3066LP	66-3066RP	66	30	30	26 1/4	3	150	38.7	T\$ 1248
										P\$ 1425 TXT\$ 1561

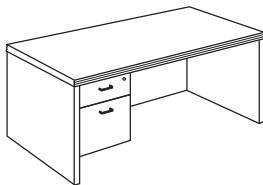
Description

- Recessed Front
- Rectangular Top
- Letter Width Locking Pedestal
- Box/File in Pedestal
- Wire Management from Pedestal to Kneespace
- Black Utility Tray for Box Drawer

All pedestal desks shown as left.



Recessed Front

For ordering options, see back of Canvas Identification card at the beginning of section.

For grommet options, see page 35.

For center drawer options, see page 73.

Item	Model No.	W	D	H	K	R	Ship Wt	Cubic Ft	List Price	
EXECUTIVE CURVED SINGLE FULL PED DESK BOW TOP	Left Ped									
	Right Ped									
	68-4872CBLP	68-4872CBRP	72	48-30	30	-	-	365	68.5	T\$ 2157
										P\$ 2373
										TXT\$ 2696

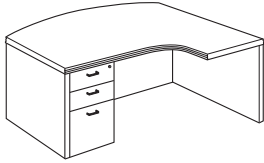
Description

- Bow Top
- Recessed Front
- Letter Width Locking Pedestal
- Box/Box/File in Pedestal
- Wire Management from Pedestal to Kneespace
- Black Utility Tray for Box Drawer

Item	Model No.	W	D	H	K	R	Ship Wt	Cubic Ft	List Price	
EXECUTIVE CURVED SINGLE FULL PED DESK RECTANGULAR TOP	Left Ped									
	Right Ped									
	68-4272CLP	68-4272CRP	72	42-30	30	-	-	350	65.8	T\$ 2044
										P\$ 2255
										TXT\$ 2554

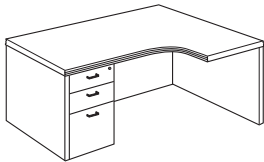
Description

- Rectangular Top
- Recessed Front
- Letter Width Locking Pedestal
- Box/Box/File in Pedestal
- Wire Management from Pedestal to Kneespace
- Black Utility Tray for Box Drawer

All pedestal desks shown as left.

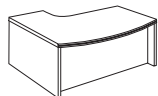

Recessed Front

For ordering options, see back of Canvas Identification card at the beginning of section.

For grommet options, see page 35.

For center drawer options, see page 73.

Item	Model No.	W	D	H	K	R	Ship Wt	Cubic Ft	List Price	
P-TOP CYLINDER BASE	Left Top	Right Top								
	66-4284PL	66-4284PR	84	42-36	30	-	-	161	59.8	T\$ 1803 P\$ 2258 TXT\$ 2254
	66-4272PL	66-4272PR	72	42-36	30	-	-	161	59.8	T\$ 1654 P\$ 2009 TXT\$ 2067

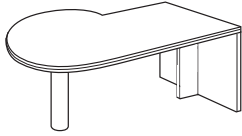

Description

- End Panel Support
- Metal Cylinder Base - 4 1/2" Diameter. Must Specify: Black or Aluminum.
- Not Recommended for Freestanding Applications

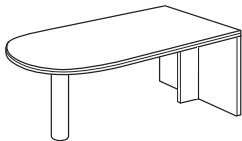

Options: Specify & Add		84"	72"
H66-MD	Optional Half Modesty Panel	\$ 61	\$ 55
66-FMD	Optional Full Modesty Panel	\$ 114	\$ 103
66-HMF	Optional Laminate Framed Acrylic Half Modesty Panel in Select Colors	\$ 315	\$ 281
66-HSC	Optional Metallic Framed Acrylic Half Modesty Panel	\$ 381	\$ 341

Item	Model No.	W	D	H	K	R	Ship Wt	Cubic Ft	List Price	
D-TOP CYLINDER BASE	Left Top	Right Top								
	66-3684DUL	66-3684DUR	84	36	30	-	-	187	60.5	T\$ 1620 P\$ 2063 TXT\$ 2024
	66-3672DUL	66-3672DUR	72	36	30	-	-	160	50.0	T\$ 1378 P\$ 1737 TXT\$ 1723
	66-3084DUL	66-3084DUR	84	30	30	-	-	190	51.0	T\$ 1568 P\$ 1968 TXT\$ 1961
	66-3072DUL	66-3072DUR	72	30	30	-	-	160	44.0	T\$ 1335 P\$ 1687 TXT\$ 1668
	66-3066DUL	66-3066DUR	66	30	30	-	-	146	40.0	T\$ 1275 P\$ 1618 TXT\$ 1594



Description

- End Panel Support
- Metal Cylinder Base - 4 1/2" Diameter. Must Specify: Black or Aluminum.
- Not Recommended for Freestanding Applications

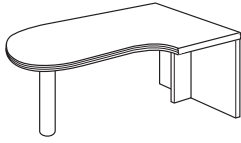

Options: Specify & Add		84"	72"	66"
66-HMD	Optional Half Modesty Panel	\$ 61	\$ 55	\$ 48
66-FMD	Optional Full Modesty Panel	\$ 114	\$ 103	\$ 92
66-HMF	Optional Laminate Framed Acrylic Half Modesty Panel in Select Colors	\$ 314	\$ 281	\$ 250
66-HSC	Optional Metallic Framed Acrylic Half Modesty Panel	\$ 381	\$ 341	\$ 304

Item	Model No.	W	D	H	K	R	Ship Wt	Cubic Ft	List Price	
EXTENDED D-TOP CYLINDER BASE	Left Top									
	Right Top									
	66-4272EDL	66-4272EDR	72	42-30	30	-	-	163	58.0	T\$ 1390
										P\$ 1776
										TXT\$ 1738

Description

- End Panel Support
- Metal Cylinder Base - 4 1/2" Diameter. Must Specify: Black or Aluminum
- Not Recommended for Freestanding Applications

Option: Specify & Add

66-HMD	Optional Half Modesty Panel	\$	55
66-FMD	Optional Full Modesty Panel	\$	103
66-HMF	Optional Laminate Framed Acrylic Half Modesty Panel in Select Colors	\$	281
66-HSC	Optional Metallic Framed Acrylic Half Modesty Panel	\$	341

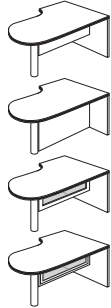

For ordering options, see back of Canvas Identification card at the beginning of section.

For grommet options, see page 35.

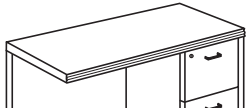
Item	Model No.	W	D	H	K	R	Ship Wt	Cubic Ft	List Price	
EXECUTIVE FULL PEDESTAL RETURN FILE/FILE 	Left Ped	Right Ped								
	68-2448LF2	68-2448RF2	48	24	30	32 1/4	-	151	23.1	T\$ 1037 P\$ 1162 TXT\$ 1298
	68-2442LF2	68-2442RF2	42	24	30	26 1/4	-	133	20.4	T\$ 994 P\$ 1107 TXT\$ 1243

Description

- Letter Width Locking Pedestal
- File/File in Pedestal
- Wire Management from Pedestal to Kneespace
- Optional Grommet Standard in Back Panel
- Grain Direction Runs Front to Back on Worksurface
- Sit-to-Stand Option Available, See Page 36

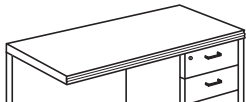
EXECUTIVE FULL PEDESTAL RETURN BOX/BOX/FILE 	Left Ped	Right Ped								
	68-2448LF1	68-2448RF1	48	24	30	32 1/4	-	151	23.1	T\$ 1037 P\$ 1162 TXT\$ 1298
	68-2442LF1	68-2442RF1	42	24	30	26 1/4	-	133	20.4	T\$ 994 P\$ 1107 TXT\$ 1243

Description

- Letter Width Locking Pedestal
- Box/Box/File in Pedestal
- Wire Management from Pedestal to Kneespace
- Optional Grommet Standard in Back Panel
- Grain Direction Runs Front to Back on Worksurface
- Sit-to-Stand Option Available, See Page 36

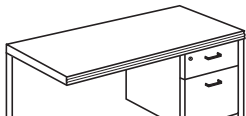
EXECUTIVE 3/4 PEDESTAL RETURN BOX/FILE 	Left Ped	Right Ped								
	66-2448LF	66-2448RF	48	24	30	32 1/4	-	125	23.1	T\$ 958 P\$ 1083 TXT\$ 1198
	66-2442LF	66-2442RF	42	24	30	26 1/4	-	110	20.4	T\$ 866 P\$ 981 TXT\$ 1083

Description

- Letter Width Locking Pedestal
- Box/File in Pedestal
- Wire Management from Pedestal to Kneespace
- Optional Grommet Standard in Back Panel
- Grain Direction Runs Front to Back on Worksurface

All returns shown as right.

For ordering options, see back of Canvas Identification card at the beginning of section.

For grommet options, see page 35.

For center drawer options, see page 73.

Item	Model No.	W	D	H	K	R	Ship Wt	Cubic Ft	List Price
EXECUTIVE MULTI-FILE RETURN BOX/BOX/FILE/LATERAL	Left Ped	Right Ped							
	66-2472LMR	66-2472RMR	72	24	30	36	-	280	33.6

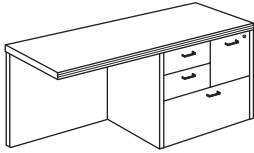
Description

- Locking File Drawers Only
- Box/Box/File/Lateral in Pedestal
- Wire Management from Pedestal to Kneespace
- Optional Grommet Standard in Back Panel
- Grain Direction Runs Left to Right on Worksurface

EXTENDED FULL PEDESTAL RETURN FILE/FILE	Left Ped	Right Ped								
	68-4824LF2	68-4824RF2	48	24	30	32 1/4	-	151	23.1	T\$ 1037 P\$ 1162 TXT\$ 1298
	68-4224LF2	68-4224RF2	42	24	30	26 1/4	-	133	20.4	T\$ 994 P\$ 1107 TXT\$ 1243

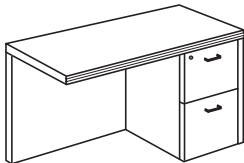
Description

- Letter Width Locking Pedestal
- File/File in Pedestal
- Wire Management from Pedestal to Kneespace
- Optional Grommet Standard in Back Panel
- Grain Direction Runs Left to Right on Worksurface
- For Use with Extended Corner Units and Standard Corner Units
- Sit-to-Stand Option Available, See Page 36

EXTENDED FULL PEDESTAL RETURN BOX/BOX/FILE	Left Ped	Right Ped								
	68-4824LF1	68-4824RF1	48	24	30	32 1/4	-	151	23.1	T\$ 1037 P\$ 1162 TXT\$ 1298
	68-4224LF1	68-4224RF1	42	24	30	26 1/4	-	133	20.4	T\$ 994 P\$ 1107 TXT\$ 1243

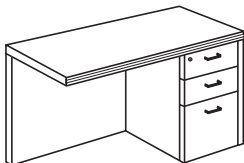
Description

- Letter Width Locking Pedestal
- Box/Box/File in Pedestal
- Wire Management from Pedestal to Kneespace
- Optional Grommet Standard in Back Panel
- Grain Direction Runs Left to Right on Worksurface
- For Use with Extended Corner Units and Standard Corner Units
- Sit-to-Stand Option Available, See Page 36

All returns shown as right.

For ordering options, see back of Canvas Identification card at the beginning of section.

For grommet options, see page 35.

For center drawer options, see page 73.

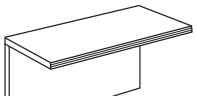
Item	Model No.	W	D	H	K	R	Ship Wt	Cubic Ft	List Price	
EXECUTIVE BRIDGE FULL MODESTY	66-2448UF	48	24	30	48	-	82	5.3	T\$	473
									P\$	599
									TXT\$	593
	66-2442UF	42	24	30	42	-	68	4.7	T\$	456
									P\$	569
									TXT\$	570

Description

- Optional Grommet Standard in Back Panel
- Grain Direction Runs Front to Back on Worksurface
- Hinged Back Panel
- Sit-to-Stand Option Available, See Page 36

NOTE: Keyboards can not be factory installed.

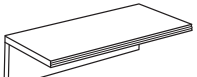
EXECUTIVE BRIDGE HALF MODESTY	66-2448UFH	48	24	11	48	-	78	5.3	T\$	447
									P\$	571
									TXT\$	558
	66-2442UFH	42	24	11	42	-	74	4.6	T\$	429
									P\$	542
									TXT\$	536

Description

- Grain Direction Runs Front to Back on Worksurface
- Hinged Back Panel

NOTE: Keyboards can not be factory installed.

For ordering options, see back of Canvas Identification card at the beginning of section.

Item	Model No.	W	D	H	K	R	Ship Wt	Cubic Ft	List Price
CORNER UNIT	66-4242CU	42	42	30	25 7/16	-	145	34.5	T\$ 1012 P\$ 1164 TXT\$ 1265
	66-3636CU	36	36	30	17	-	109	26.3	T\$ 840 P\$ 964 TXT\$ 1050

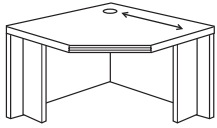
Description

- Freestanding Support Unit
- Connects to 24" Deep Worksurfaces
- Grommet in Top
- Grain Direction Runs as Shown on Worksurface

NOTE: Not all keyboards will fit the 66-3636CU. Recommended keyboards are 1-KCWR, 1-KCPR, and 1-KC.

Item	Model No.	W	D	H	K	R	Ship Wt	Cubic Ft	List Price
CURVED CORNER UNIT	66-4242CCU	42	42	30	25 7/16	-	145	34.5	T\$ 1250 P\$ 1435 TXT\$ 1563
	66-3636CCU	36	36	30	17	-	109	26.3	T\$ 1083 P\$ 1233 TXT\$ 1352

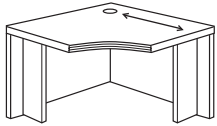
Description

- Freestanding Support Unit
- Connects to 24" Deep Worksurfaces
- Grommet in Top
- Grain Direction Runs as Shown on Worksurface

NOTE: Not all keyboards will fit the 66-3636CCU. Recommended keyboards are 1-KCWR, 1-KCPR, and 1-KC.

Item	Left Unit	Right Unit	W	D	H	K	R	Ship Wt	Cubic Ft	List Price
EXTENDED CORNER UNIT	66-4854ECCL	66-4854ECCR	48	54	30	-	-	174	41.1	T\$ 1549 P\$ 1769 TXT\$ 1936

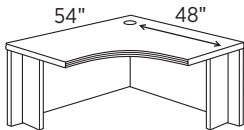

Shown as Right

Description

- Grain Direction Runs as Shown on Worksurface

For ordering options, see back of Canvas Identification card at the beginning of section.

For grommet options, see page 35.

Item	Model No.	W	D	H	K	R	Ship Wt	Cubic Ft	List Price	
EXECUTIVE FULL PEDESTAL CREDENZA FILE/FILE	Left Ped	Right Ped								
	68-2472LC2	68-2472RC2	72	24	30	32 1/4	-	199	35.6	T\$ 1306 P\$ 1467 TXT\$ 1632
	68-2466LC2	68-2466RC2	66	24	30	26 1/4	-	182	32.7	T\$ 1293 P\$ 1446 TXT\$ 1617

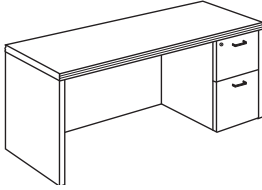
Description

- Letter Width Locking Pedestal
- File/File in Pedestal
- Wire Management from Pedestal to Kneespace
- Optional Grommet Standard in Back Panel
- Sit-to-Stand Option Available, See Page 36

EXECUTIVE FULL PEDESTAL CREDENZA BOX/BOX/FILE	Left Ped	Right Ped								
	68-2472LC1	68-2472RC1	72	24	30	32 1/4	-	199	35.6	T\$ 1306 P\$ 1467 TXT\$ 1632
	68-2466LC1	68-2466RC1	66	24	30	26 1/4	-	182	32.7	T\$ 1293 P\$ 1446 TXT\$ 1617

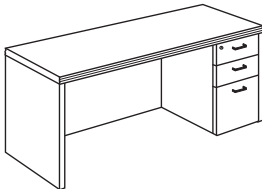
Description

- Letter Width Locking Pedestal
- Box/Box/File in Pedestal
- Wire Management from Pedestal to Kneespace
- Optional Grommet Standard in Back Panel
- Sit-to-Stand Option Available, See Page 36

EXECUTIVE 3/4 PEDESTAL CREDENZA BOX/FILE	Left Ped	Right Ped								
	66-2472LC	66-2472RC	72	24	30	32 1/4	-	242	35.6	T\$ 1175 P\$ 1336 TXT\$ 1469
	66-2466LC	66-2466RC	66	24	30	26 1/4	-	170	32.7	T\$ 1146 P\$ 1300 TXT\$ 1434

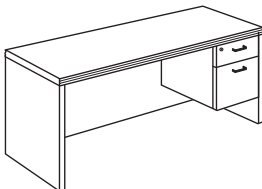
Description

- Letter Width Locking Pedestal
- Box/File in Pedestal
- Wire Management from Pedestal to Kneespace
- Optional Grommet Standard in Back Panel

All credenzas shown as right.

For ordering options, see back of Canvas Identification card at the beginning of section.

For grommet options, see page 35.

Item	Model No.	W	D	H	K	R	Ship Wt	Cubic Ft	List Price	
EXECUTIVE FULL PEDESTAL CREENZA LATERAL/LATERAL	Left Ped	Right Ped								
	66-2472LL	66-2472RL	72	24	30	12	-	277	35.6	T\$ 1716 P\$ 1877 TXT\$ 2145
	66-2466LL	66-2466RL	66	24	30	6	-	264	32.7	T\$ 1693 P\$ 1846 TXT\$ 2116

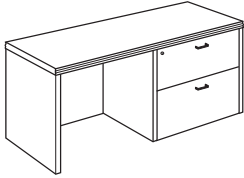
Description

- Central Locking
- Two Lateral File Drawers Provide Legal or Letter Filing Front to Back or Side to Side
- Optional Grommet Standard in Back Panel

Item	Model No.	W	D	H	K	R	Ship Wt	Cubic Ft	List Price	
EXECUTIVE MULTI-FILE PEDESTAL CREENZA BOX/BOX/FILE/LATERAL	Left Ped	Right Ped								
	66-2472LMF	66-2472RMF	72	24	30	12	-	277	35.6	T\$ 1801 P\$ 1962 TXT\$ 2251
	66-2466LMF	66-2466RMF	66	24	30	6	-	264	32.7	T\$ 1776 P\$ 1930 TXT\$ 2221

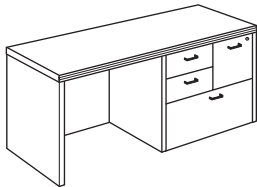

Description

- Locking File Drawers Only
- Box/Box/File/Lateral in Pedestal
- Optional Grommet Standard in Back Panel

All credenzas shown as right.

For ordering options, see back of Canvas Identification card at the beginning of section.

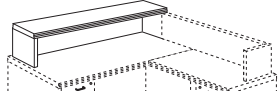
For grommet options, see page 35.

Item	Model No.	W	D	H	K	R	Ship Wt	Cubic Ft	List Price		
TRANSACTION RISER FOR DESKS/CREDENZAS	66-1272TR	72	12	13	-	-	60	9.9	T\$	615	
	For Use with 72" Wide Worksurfaces									P\$	716
										TXT\$	770
	66-1266TR	66	12	13	-	-	52	9.9	T\$	600	
	For Use with 66" Wide Worksurfaces									P\$	697
										TXT\$	750

Description

- Freestanding Riser for Desks or Credenzas
- May Be Used in Conjunction with Return Risers or Bridge Risers

TRANSACTION RISER FOR RETURNS	Left Ped	Right Ped	W	D	H	K	R	Ship Wt	Cubic Ft	List Price		
	66-1272LU	66-1272RU	72	12	12	-	-	40	9.9	T\$	493	
For Use with 36" Desks and 48" Returns											TXT\$	615
66-1266LU	66-1266RU	66	12	12	-	-	35	9.9	T\$	480		
For Use with 30" Desks and 48" Returns											TXT\$	599

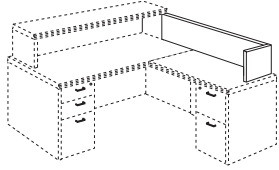
Description

- Must Be Used in Conjunction with a Desk Riser

TRANSACTION RISER FOR BRIDGES	66-1284BP	84	1	12	-	-	47	2.0	T\$	326		
For Use with 36" Desks, 48" Bridge, and Credenza											TXT\$	409

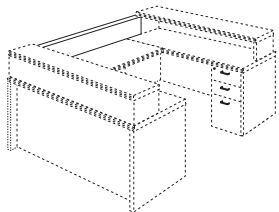

Description

- Must Be Used in Conjunction with Two Desk/Credenza Risers

For ordering options, see back of Canvas Identification card at the beginning of section.

For grommet options, see page 35.

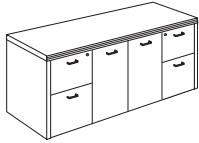
Item	Model No.	W	D	H	K	R	Ship Wt	Cubic Ft	List Price
STORAGE CREENZA FULL PEDESTAL	68-2472SC	72	24	30	-	-	285	35.6	T\$ 1974 P\$ 2133 TXT\$ 2468
	68-2466SC	66	24	30	-	-	261	32.7	T\$ 1893 P\$ 2046 TXT\$ 2367

Description

- Letter Width Locking Pedestals
- File/File in Both Pedestals
- Fixed Storage Shelf Behind Doors

STORAGE CREENZA 3/4 PEDESTAL	66-2472SC	72	24	30	-	-	262	35.6	T\$ 1770 P\$ 1931 TXT\$ 2213
	66-2466SC	66	24	30	-	-	240	32.7	T\$ 1654 P\$ 1807 TXT\$ 2067

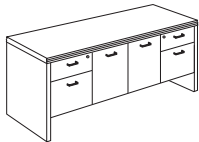
Description

- Letter Width Locking Pedestals
- Box/File in Both Pedestals

KNEESPACE CREENZA FULL PEDESTAL	68-2472KC	72	24	30	39	-	240	35.6	T\$ 1826 P\$ 1987 TXT\$ 2283
	68-2466KC	66	24	30	33	-	220	32.7	T\$ 1699 P\$ 1851 TXT\$ 2124

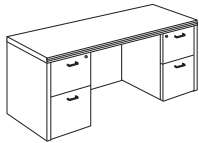
Description

- Letter Width Locking Pedestals
- File/File in Both Pedestals
- Wire Management from Pedestal to Kneespace
- Optional Grommet Standard in Back Panel
- Sit-to-Stand Option Available, See Page 36

KNEESPACE CREENZA 3/4 PEDESTAL	66-2472KC	72	24	30	39	-	227	35.6	T\$ 1622 P\$ 1782 TXT\$ 2027
	66-2466KC	66	24	30	33	-	208	32.7	T\$ 1472 P\$ 1626 TXT\$ 1840

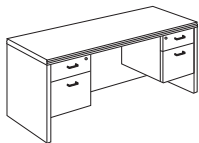
Description

- Letter Width Locking Pedestals
- Box/File in Both Pedestals
- Wire Management from Pedestal to Kneespace
- Optional Grommet Standard in Back Panel

For ordering options, see back of Canvas Identification card at the beginning of section.

Item	Model No.	W	D	H	K	R	Ship Wt	Cubic Ft	List Price
DOUBLE LATERAL CREDENZA	66-2472DL	72	24	30	-	-	360	35.7	T\$ 2375
									P\$ 2536
									TXT\$ 2969

Description

- Dual Locking
- File Drawers Provide Legal or Letter Filing
- 1/4" Thick Drawer Bottoms Allow for Storage Applications

FOUR DRAWER LATERAL FILE	66-2436L4	36	24	57 1/2	-	-	312	32.6	T\$ 2044
									P\$ 2144
									TXT\$ 2554
	66-2430L4	30	24	57 1/2	-	-	260	27.5	T\$ 1947
									P\$ 2044
									TXT\$ 2434

Description

- Central Locking
- Anti-Tilt System
- File Drawers Provide Legal or Letter Filing Front to Back or Side to Side
- 1/4" Thick Drawer Bottoms Allow for Storage Applications

TWO DRAWER LATERAL FILE	66-2436L2	36	24	30	-	-	184	18.3	T\$ 1081
									P\$ 1181
									TXT\$ 1351
	66-2430L2	30	24	30	-	-	153	15.6	T\$ 1026
									P\$ 1124
									TXT\$ 1282

Description

- Central Locking
- Anti-Tilt System
- File Drawers Provide Legal or Letter Filing Front to Back or Side to Side
- 1/4" Thick Drawer Bottoms Allow for Storage Applications

For ordering options, see back of Canvas Identification card at the beginning of section.

Item	Model No.	W	D	H	K	R	Ship Wt	Cubic Ft	List Price	
MULTI-FILE	66-2436MF	36	24	30	-	-	184	18.3	T\$	1162
									P\$	1263
									TXT\$	1452

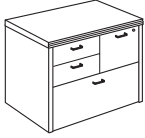
Description

- Upper Section - Box/Box/File
- Lower Section - Lateral File
- Locking File Drawers
- One Lateral File Drawer Provides Legal or Letter Filing

MOBILE PEDESTAL	66-1519MP	15 3/4	19	23	-	-	85	9.0	T\$	829
									TXT\$	1037

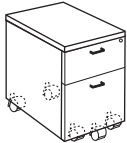
Description

- Letter Width Locking Pedestal
- Box/File in Pedestal
- Casters Allow for Easy Moving
- Fits Underneath 30" H Worksurface

For ordering options, see back of Canvas Identification card at the beginning of section.

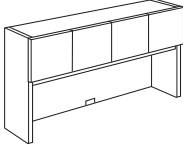
Item	Model No.	W	D	H	K	R	Ship Wt	Cubic Ft	List Price	
	SURFACE MOUNT DOOR HUTCHES	66-15108HU	108	15	40 7/8	-	-	301	51.7	T\$ 2168
	Six Doors	66-15102HU	102	15	40 7/8	-	-	283	48.3	T\$ 2078
	Six Doors	66-1596HU	96	15	40 7/8	-	-	260	46.5	T\$ 2045 TXT\$ 2555
	Six Doors	66-1590HU	90	15	40 7/8	-	-	243	44.3	T\$ 1912 TXT\$ 2390
	Five Doors	66-1584HU	84	15	40 7/8	-	-	228	40.0	T\$ 1648 TXT\$ 2060
	Five Doors	66-1578HU	78	15	40 7/8	-	-	210	36.7	T\$ 1606 TXT\$ 2009
	Four Doors	66-1572HU	72	15	40 7/8	-	-	203	34.1	T\$ 1355 TXT\$ 1695
	Four Doors	66-1566HU	66	15	40 7/8	-	-	166	32.1	T\$ 1307 TXT\$ 1633
	Four Doors									

Description

- Grommet
- Additional Support is Required when Surface Mounted Hutches Do Not Sit Directly Over an End Panel or Pedestal, See Page 80 to Order 66-2812SP
- Component Hutch Tops with Profiles are Available, See Page 62
- Optional Locking Available on Solid Panel Doors Only, See Page 35
- 23 1/8" Clearance Below Doors

Options: Specify & Add

1-AD	Metallic Framed Frosted Acrylic Doors	\$75 per Door
1-MF	Laminate Framed Frosted Acrylic Doors in Select Colors	\$75 per Door

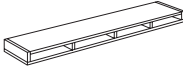
Item	Model No.	W	D	H	K	R	Ship Wt	Cubic Ft	List Price	
	OPTIONAL PAPER SLOTS FOR SURFACE MOUNT HUTCHES	66-11106PS	106 1/2	11 7/8	5 1/4	-	-	62	4.7	T\$ 915
	Six Slots	66-11100PS	100 1/2	11 7/8	5 1/4	-	-	59	4.5	T\$ 857
	Six Slots	66-1194PS	94 1/2	11 7/8	5 1/4	-	-	55	4.2	T\$ 800 TXT\$ 999
	Six Slots	66-1188PS	88 1/2	11 7/8	5 1/4	-	-	52	3.9	T\$ 742 TXT\$ 927
	Five Slots	66-1182PS	82 1/2	11 7/8	5 1/4	-	-	49	3.7	T\$ 683 TXT\$ 854
	Five Slots	66-1176PS	76 1/2	11 7/8	5 1/4	-	-	45	3.4	T\$ 627 TXT\$ 783
	Four Slots	66-1170PS	70 1/2	11 7/8	5 1/4	-	-	42	3.1	T\$ 568 TXT\$ 710
	Four Slots	66-1164PS	64 1/2	11 7/8	5 1/4	-	-	38	2.9	T\$ 508 TXT\$ 636
	Four Slots									

Description

- Optional Paper Slot for Surface Mount Hutches
- Ships Factory Installed

For ordering options, see back of Canvas Identification card at the beginning of section.

For tackboard and tasklights, see pages 96-97.

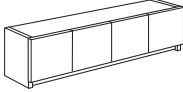
Item	Model No.	W	D	H	K	R	Ship Wt	Cubic Ft	List Price
WALL MOUNT DOOR HUTCHES 	66-15108WD Six Doors	108	15	17 3/16	-	-	178	19.4	T\$ 1952
	66-15102WD Six Doors	102	15	17 3/16	-	-	168	18.3	T\$ 1869
	66-1596WD Six Doors	96	15	17 3/16	-	-	158	17.3	T\$ 1841 TXT\$ 2301
	66-1590WD Five Doors	90	15	17 3/16	-	-	148	16.2	T\$ 1719 TXT\$ 2150
	66-1584WD Five Doors	84	15	17 3/16	-	-	138	15.2	T\$ 1483 TXT\$ 1853
	66-1578WD Four Doors	78	15	17 3/16	-	-	128	14.1	T\$ 1448 TXT\$ 1810
	66-1572WD Four Doors	72	15	17 3/16	-	-	118	13.1	T\$ 1216 TXT\$ 1521
	66-1566WD Four Doors	66	15	17 3/16	-	-	105	12.0	T\$ 1175 TXT\$ 1469
	66-1560WD Four Doors	60	15	17 3/16	-	-	96	11.0	T\$ 1157 TXT\$ 1446
	66-1554WD Three Doors	54	15	17 3/16	-	-	87	9.9	T\$ 1074 TXT\$ 1344
	66-1548WD Three Doors	48	15	17 3/16	-	-	77	8.9	T\$ 994 TXT\$ 1243
	66-1542WD Two Doors	42	15	17 3/16	-	-	67	7.8	T\$ 745 TXT\$ 931
	66-1536WD Two Doors	36	15	17 3/16	-	-	58	6.7	T\$ 649 TXT\$ 812
	66-1530WD Two Doors	30	15	17 3/16	-	-	48	5.6	T\$ 563 TXT\$ 704

Description

- Storage Behind Doors
- Component Hutch Tops with Profiles are Available, See Page 62
- Optional Locking Available on Solid Panel Doors Only, See Page 35

Options: Specify & Add

1-AD	Metallic Framed Frosted Acrylic Doors	\$75 per Door
------	---------------------------------------	---------------

1-MF	Laminate Framed Frosted Acrylic Doors in Select Colors	\$75 per Door
------	--	---------------

NOTE: Indiana Furniture will not be liable for wall mount hutches that are not properly installed.

For ordering options, see back of Canvas Identification card at the beginning of section.

For tackboard and tasklights, see pages 96-97.

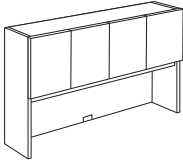
Item	Model No.	W	D	H	K	R	Ship Wt	Cubic Ft	List Price	
TALL SURFACE MOUNT DOOR HUTCHES 	66-15108THU Six Doors	108	15	52 7/8	-	-	313	64.2	T\$	2481
	66-15102THU Six Doors	102	15	52 7/8	-	-	296	60.7	T\$	2402
	66-1596THU Six Doors	96	15	52 7/8	-	-	278	57.7	T\$	2359 TXT\$ 2949
	66-1590THU Five Doors	90	15	52 7/8	-	-	260	53.7	T\$	2239 TXT\$ 2799
	66-1584THU Five Doors	84	15	52 7/8	-	-	243	50.2	T\$	2004 TXT\$ 2506
	66-1578THU Four Doors	78	15	52 7/8	-	-	226	46.7	T\$	1965 TXT\$ 2457
	66-1572THU Four Doors	72	15	52 7/8	-	-	264	43.3	T\$	1727 TXT\$ 2158
	66-1566THU Four Doors	66	15	52 7/8	-	-	242	39.7	T\$	1671 TXT\$ 2089

Description

- One Fixed Shelf Behind Doors
- Grommet
- Additional Support is Required when Surface Mounted Hutches Do Not Sit Directly Over an End Panel or Pedestal, See Page 80 to Order 66-2812SP
- Component Hutch Tops with Profiles are Available, See Page 62
- Optional Locking Available on Solid Panel Doors Only, See Page 35
- Optional Paperslots, See Page 56

Options: Specify & Add

1-AD	Metallic Framed Frosted Acrylic Doors	\$167 per Door
1-MF	Laminate Framed Frosted Acrylic Doors in Select Colors	\$167 per Door

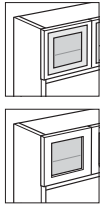

For ordering options, see back of Canvas Identification card at the beginning of section.

For tackboard and tasklights, see pages 96-97.

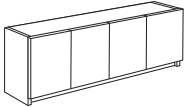
Item	Model No.	W	D	H	K	R	Ship Wt	Cubic Ft	List Price
TALL WALL MOUNT DOOR HUTCHES 	66-15108TWD Six Doors	108	15	29 3/16	-	-	281	55.1	T\$ 2296
	66-15102TWD Six Doors	102	15	29 3/16	-	-	265	60.7	T\$ 2241
	66-1596TWD Six Doors	96	15	29 3/16	-	-	249	57.2	T\$ 2154 TXT\$ 2692
	66-1590TWD Five Doors	90	15	29 3/16	-	-	233	53.7	T\$ 1959 TXT\$ 2449
	66-1584TWD Five Doors	84	15	29 3/16	-	-	217	50.2	T\$ 1843 TXT\$ 2304
	66-1578TWD Four Doors	78	15	29 3/16	-	-	201	28.3	T\$ 1808 TXT\$ 2261
	66-1572TWD Four Doors	72	15	29 3/16	-	-	185	43.2	T\$ 1592 TXT\$ 1990
	66-1566TWD Four Doors	66	15	29 3/16	-	-	170	22.0	T\$ 1523 TXT\$ 1904
	66-1560TWD Four Doors	60	15	29 3/16	-	-	155	20.1	T\$ 1448 TXT\$ 1810
	66-1554TWD Three Doors	54	15	29 3/16	-	-	140	18.1	T\$ 1336 TXT\$ 1669
	66-1548TWD Three Doors	48	15	29 3/16	-	-	124	16.2	T\$ 1248 TXT\$ 1561
	66-1542TWD Two Doors	42	15	29 3/16	-	-	109	12.3	T\$ 1014 TXT\$ 1267
	66-1536TWD Two Doors	36	15	29 3/16	-	-	93	12.3	T\$ 955 TXT\$ 1193
	66-1530TWD Two Doors	30	15	29 3/16	-	-	77	9.1	T\$ 894 TXT\$ 1119

Description

- One Fixed Shelf Behind Doors
- Component Hutch Tops with Profiles are Available, See Page 62
- Optional Locking Available on Solid Panel Doors Only, See Page 35

Options: Specify & Add

1-AD	Metallic Framed Frosted Acrylic Doors	\$167 per Door
------	---------------------------------------	----------------

1-MF	Laminate Framed Frosted Acrylic Doors in Select Colors	\$167 per Door
------	--	----------------

NOTE: Indiana Furniture will not be liable for wall mount hutches that are not properly installed.

For ordering options, see back of Canvas Identification card at the beginning of section.

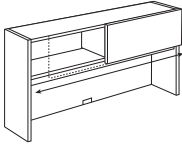
Item	Model No.	W	D	H	K	R	Ship Wt	Cubic Ft	List Price
SURFACE MOUNT SLIDING DOOR HUTCHES 	66-15108SHU Two Doors	108	15	40 7/8	-	-	313	64.2	T\$ 2515
	66-15102SHU Two Doors	102	15	40 7/8	-	-	296	60.7	T\$ 2338
	66-1596SHU Two Doors	96	15	40 7/8	-	-	278	57.7	T\$ 2226 TXT\$ 2782
	66-1590SHU Two Doors	90	15	40 7/8	-	-	260	53.7	T\$ 2174 TXT\$ 2718
	66-1584SHU Two Doors	84	15	40 7/8	-	-	243	50.2	T\$ 1868 TXT\$ 2335
	66-1578SHU One Door	78	15	40 7/8	-	-	226	46.7	T\$ 1788 TXT\$ 2235
	66-1572SHU One Door	72	15	40 7/8	-	-	264	43.3	T\$ 1566 TXT\$ 1958
	66-1566SHU One Door	66	15	40 7/8	-	-	242	39.7	T\$ 1519 TXT\$ 1899

Description

- Grommet
- Additional Support is Required when Surface Mounted Hutches Do Not Sit Directly Over an End Panel or Pedestal, See Page 80 to Order 66-2812SP
- Optional Hutch Tops with Profiles are Available, See Page 62
- Optional Paperslots, See Page 56

Options: Specify & Add

1-AD	Metallic Framed Frosted Acrylic Doors	\$215 per Door
1-MF	Laminate Framed Frosted Acrylic Doors in Select Colors	\$215 per Door

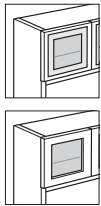

For ordering options, see back of Canvas Identification card at the beginning of section.

For tackboard and tasklights, see pages 96-97.

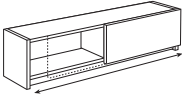
Item	Model No.	W	D	H	K	R	Ship Wt	Cubic Ft	List Price
WALL MOUNT SLIDING DOOR HUTCHES 	66-15108SWD Two Doors	108	15	17 ³ / ₁₆	-	-	281	55.1	T\$ 2328
	66-15102SWD Two Doors	102	15	17 ³ / ₁₆	-	-	265	60.7	T\$ 2215
	66-1596SWD Two Doors	96	15	17 ³ / ₁₆	-	-	249	57.2	T\$ 2120 TXT\$ 2650
	66-1590SWD Two Doors	90	15	17 ³ / ₁₆	-	-	233	53.7	T\$ 1984 TXT\$ 2480
	66-1584SWD Two Doors	84	15	17 ³ / ₁₆	-	-	217	50.2	T\$ 1803 TXT\$ 2254
	66-1578SWD One Door	78	15	17 ³ / ₁₆	-	-	201	28.3	T\$ 1716 TXT\$ 2145
	66-1572SWD One Door	72	15	17 ³ / ₁₆	-	-	185	43.2	T\$ 1593 TXT\$ 1991
	66-1566SWD One Door	66	15	17 ³ / ₁₆	-	-	170	22.0	T\$ 1530 TXT\$ 1913

Description

- Optional Hutch Tops with Profiles are Available, See Page 62

Options: Specify & Add

1-AD	Metallic Framed Frosted Acrylic Doors	\$215 per Door
------	---------------------------------------	----------------

1-MF	Laminate Framed Frosted Acrylic Doors in Select Colors	\$215 per Door
------	--	----------------

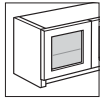
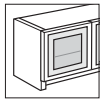

NOTE: Indiana Furniture will not be liable for wall mount hutches that are not properly installed.

For ordering options, see back of Canvas Identification card at the beginning of section.

For tackboard and tasklights, see pages 96-97.

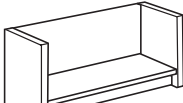
Item	Model No.	W	D	H	K	R	Ship Wt	Cubic Ft	List Price
OPEN STORAGE WALL MOUNT HUTCH 	66-1542WN	42	14 1/4	17 3/16	-	-	55	7.8	T\$ 711 TXT\$ 889
	66-1536WN	36	14 1/4	17 3/16	-	-	42	6.7	T\$ 617 TXT\$ 773
	66-1530WN	30	14 1/4	17 3/16	-	-	36	5.6	T\$ 539 TXT\$ 674

Description

- Open Shelf Storage

NOTE: Indiana Furniture will not be liable for wall mount hutches that are not properly installed.

Item	Model No.	W	D	H	K	R	Ship Wt	Cubic Ft	List Price
COMPONENT TOP FOR 15" DEEP HUTCHES & BOOKCASES 	66-15108HT	108	15	1	-	-	67	5.7	T\$ 413
	66-15102HT	102	15	1	-	-	63	5.4	T\$ 403
	66-1596HT	96	15	1	-	-	61	5.1	T\$ 388 TXT\$ 486
	66-1590HT	90	15	1	-	-	57	4.8	T\$ 374 TXT\$ 466
	66-1584HT	84	15	1	-	-	53	4.5	T\$ 356 TXT\$ 446
	66-1578HT	78	15	1	-	-	50	4.2	T\$ 348 TXT\$ 434
	66-1572HT	72	15	1	-	-	48	3.9	T\$ 324 TXT\$ 405
	66-1566HT	66	15	1	-	-	42	3.5	T\$ 309 TXT\$ 386
	66-1560HT	60	15	1	-	-	38	3.2	T\$ 301 TXT\$ 377
	66-1554HT	54	15	1	-	-	34	2.9	T\$ 295 TXT\$ 369
	66-1548HT	48	15	1	-	-	30	2.6	T\$ 288 TXT\$ 360
	66-1542HT	42	15	1	-	-	27	2.3	T\$ 278 TXT\$ 348
	66-1536HT	36	15	1	-	-	23	2.0	T\$ 269 TXT\$ 334
	66-1530HT	30	15	1	-	-	11	1.0	T\$ 259 TXT\$ 324

Description

- Provides an Edge Profile on Overhead Units While Giving Multiple Overhead Units a Cohesive Appearance
- Profiled on Front Edge Only
- Not Intended for Open Hutches

For ordering options, see back of Canvas Identification card at the beginning of section.

Item	Model No.	W	D	H	K	R	Ship Wt	Cubic Ft	List Price
------	-----------	---	---	---	---	---	---------	----------	------------

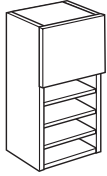
STORAGE TOWER

Hinged Left	Hinged Right	W	D	H	K	R	Ship Wt	Cubic Ft	List Price
66-1518HL1	66-1518HR1	18	15	40 7/8	-	-	78	8.6	T\$ 754 TXT\$ 944

Description

- Storage Behind Door in Upper Section
- Three Adjustable Shelves

Options: Specify & Add

1-AD	Metallic Framed Frosted Acrylic Doors	\$	75
------	---------------------------------------	----	----

1-MF	Laminate Framed Frosted Acrylic Doors in Select	\$	75
------	---	----	----

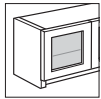
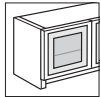
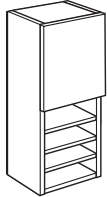
TALL STORAGE TOWER

Hinged Left	Hinged Right	W	D	H	K	R	Ship Wt	Cubic Ft	List Price
66-1518THL1	66-1518THR1	18	15	52 7/8	-	-	95	11.0	T\$ 921 TXT\$ 1151

Description

- Storage Behind Door in Upper Section with One Adjustable Shelf
- Three Adjustable Shelves in Lower Section

Options: Specify & Add

1-AD	Metallic Framed Frosted Acrylic Doors	\$	167
------	---------------------------------------	----	-----

1-MF	Laminate Framed Frosted Acrylic Doors in Select Colors	\$	167
------	--	----	-----

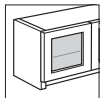
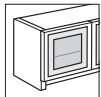
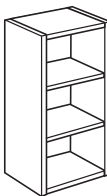
**STORAGE TOWER
OPEN BOOKCASE**

66-1518HB	W	D	H	K	R	Ship Wt	Cubic Ft	List Price
	18	14 1/4	40 7/8	-	-	62	8.6	T\$ 548 TXT\$ 684

Description

- Two Adjustable Shelves

For ordering options, see back of Canvas Identification card at the beginning of section.

Item	Model No.	W	D	H	K	R	Ship Wt	Cubic Ft	List Price	
STORAGE TOWER	Hinged Left									
	Hinged Right									
	66-1518HL3	66-1518HR3	18	15	40 7/8	-	-	78	8.6	T\$ 720 TXT\$ 901

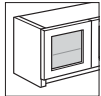
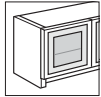
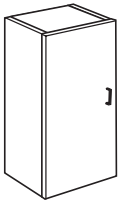
Description

- Two Adjustable Shelves

Options: Specify & Add

1-AD	Metallic Framed Frosted Acrylic Doors	\$ 204
------	---------------------------------------	--------

1-MF	Laminate Framed Frosted Acrylic Doors in Select Colors	\$ 204
------	--	--------



NOTE: A capsule pull will be substituted for Elite, Buckle, or Groove pulls.

Item	Model No.	W	D	H	K	R	Ship Wt	Cubic Ft	List Price	
TALL STORAGE TOWER	Hinged Left									
	Hinged Right									
	66-1518THL3	66-1518THR3	18	15	52 7/8	-	-	95	11.0	T\$ 856 TXT\$ 1070

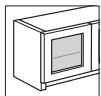
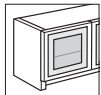
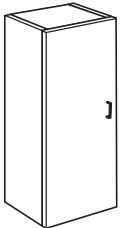
Description

- Three Adjustable Shelves

Options: Specify & Add

1-AD	Metallic Framed Frosted Acrylic Doors	\$ 267
------	---------------------------------------	--------

1-MF	Laminate Framed Frosted Acrylic Doors in Select Colors	\$ 267
------	--	--------



NOTE: A capsule pull will be substituted for Elite, Buckle, or Groove pulls.

For ordering options, see back of Canvas Identification card at the beginning of section.

Item	Model No.	W	D	H	K	R	Ship Wt	Cubic Ft	List Price
TALL STORAGE TOWER OPEN BOOKCASE	66-1518THB	18	14 1/2	52 7/8	-	-	68	11.0	T\$ 652 TXT\$ 816

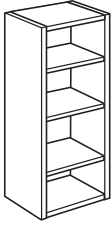
Description

- Three Adjustable Shelves

TOP UNIT DOOR BOOKCASE	66-1536TUDB	36	15	40 7/8	-	-	168	16.1	T\$ 1034 TXT\$ 1293
	66-1530TUDB	30	15	40 7/8	-	-	140	13.4	T\$ 960 TXT\$ 1201

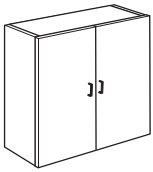
Description

- One Fixed Shelf
- Two Adjustable Shelves

Options: Specify & Add

1-AD	Metallic Framed Frosted Acrylic Doors	\$ 407
------	---------------------------------------	--------



1-MF	Laminate Framed Frosted Acrylic Doors in Select Colors	\$ 407
------	--	--------



NOTE: A capsule pull will be substituted for Elite, Buckle, or Groove pulls.

TALL TOP UNIT DOOR BOOKCASE	66-1536TTUDB	36	15	52 7/8	-	-	216	20.5	T\$ 1214 TXT\$ 1519
	66-1530TTUDB	30	15	52 7/8	-	-	180	17.3	T\$ 1103 TXT\$ 1379

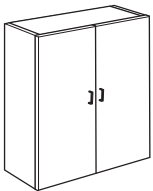
Description

- One Fixed Shelf
- Three Adjustable Shelves

Options: Specify & Add

1-AD	Metallic Framed Frosted Acrylic Doors	\$ 533
------	---------------------------------------	--------



1-MF	Laminate Framed Frosted Acrylic Doors in Select Colors	\$ 533
------	--	--------



NOTE: A capsule pull will be substituted for Elite, Buckle, or Groove pulls.

For ordering options, see back of Canvas Identification card at the beginning of section.

Item	Model No.	W	D	H	K	R	Ship Wt	Cubic Ft	List Price
------	-----------	---	---	---	---	---	---------	----------	------------

STORAGE CABINET FILE/FILE	Hinged Left	Hinged Right							
	66-1872DS2L	66-1872DS2R	18	24	70 7/8	-	-	145	22.0

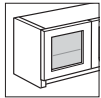
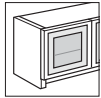
Description

- One Adjustable Shelf Behind Door
- Two Adjustable Shelves in Center Section
- File/File in Lower Section Lock and Provide Legal or Letter Filing

Options: Specify & Add

1-AD	Metallic Framed Frosted Acrylic Doors	\$	167
------	---------------------------------------	----	-----

1-MF	Laminate Framed Frosted Acrylic Doors in Select Colors	\$	167
------	--	----	-----

STORAGE CABINET BOX/BOX/FILE	Hinged Left	Hinged Right							
	66-1872DS1L	66-1872DS1R	18	24	70 7/8	-	-	145	22.0

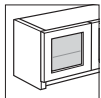
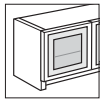
Description

- One Adjustable Shelf Behind Door
- Two Adjustable Shelves in Center Section
- Box/Box/File in Lower Section Lock and Provide Legal or Letter Filing

Options: Specify & Add

1-AD	Metallic Framed Frosted Acrylic Doors	\$	167
------	---------------------------------------	----	-----

1-MF	Laminate Framed Frosted Acrylic Doors in Select Colors	\$	167
------	--	----	-----

STORAGE CABINET FILE/FILE	Hinged Left	Hinged Right							
	66-1872WFL	66-1872WFR	18	24	70 7/8	-	-	145	22.0



NOTE: A capsule pull will be substituted for Elite, Buckle, or Groove pulls.

For ordering options, see back of Canvas Identification card at the beginning of section.

Item	Model No.	W	D	H	K	R	Ship Wt	Cubic Ft	List Price	
STORAGE CABINET BOX/BOX/FILE	Hinged Left									
	Hinged Right									
	66-1872WBL	66-1872WBR	18	24	70 7/8	-	-	145	22.0	T\$ 1538 TXT\$ 1922

Description

- Two Adjustable Shelves Behind Door
- Box/Box/File in Lower Section Lock and Provide Legal or Letter Filing



NOTE: A capsule pull will be substituted for Elite, Buckle, or Groove pulls.

OPEN STORAGE CABINET FILE/FILE	66-1872WFO		18	24	70 7/8	-	-	136	22.0	T\$ 1414 TXT\$ 1768
-----------------------------------	------------	--	----	----	--------	---	---	-----	------	------------------------

Description

- Two Adjustable Shelves in Upper Section
- File/File in Lower Section Lock and Provide Legal or Letter Filing

OPEN STORAGE CABINET BOX/BOX/FILE	66-1872WBO		18	24	70 7/8	-	-	136	22.0	T\$ 1414 TXT\$ 1768
--------------------------------------	------------	--	----	----	--------	---	---	-----	------	------------------------



Description

- Two Adjustable Shelves in Upper Section
- Box/Box/File in Lower Section Lock and Provide Legal or Letter Filing

For ordering options, see back of Canvas Identification card at the beginning of section.

Item	Model No.	W	D	H	K	R	Ship Wt	Cubic Ft	List Price
------	-----------	---	---	---	---	---	---------	----------	------------

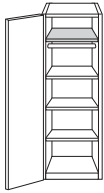
WARDROBE/STORAGE CABINET	Hinged Left	Hinged Right							
	66-1872WL	66-1872WR	18	24	70 7/8	-	-	153	19.2

Description

- Fixed Top Shelf
- Coat Rod Under Fixed Shelf
- Three Adjustable Shelves
- Adjustable Shelves can be Removed for Wardrobe Application

Options: Specify & Add

1-LOCK	Optional Locking	\$ 58
--------	------------------	-------



NOTE: A capsule pull will be substituted for Elite, Buckle, or Groove pulls.

WARDROBE/STORAGE CABINET	Model No.	W	D	H	K	R	Ship Wt	Cubic Ft	List Price
	66-3672WDS2	36	24	70 7/8	-	-	315	42.0	T\$ 2282 TXT\$ 2852

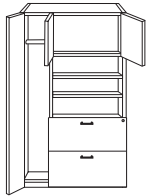
Description

- Left Side Equipped with Coat Rod
- Right Side Upper Section has Storage Behind Two Hutch Style Doors
- Right Middle Section has Two Adjustable Shelves
- Right Lower Section has Two Lateral File Drawers that Lock and Provide Legal or Letter Filing

Options: Specify & Add

1-AD	Metallic Framed Frosted Acrylic Hutch Doors	\$ 149
------	---	--------

1-MF	Laminate Framed Frosted Acrylic Hutch Doors in Select Colors	\$ 149
------	--	--------

PORTABLE PAPERSLOT TOWER	Model No.	W	D	H	K	R	Ship Wt	Cubic Ft	List Price
	66-1218HH	18	12	21	-	-	45	4.4	T\$ 562 TXT\$ 703

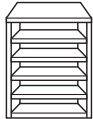
Description

- Three Adjustable Shelves

For ordering options, see back of Canvas Identification card at the beginning of section.

Item	Model No.	W	D	H	K	R	Ship Wt	Cubic Ft	List Price
VISUAL BOARD	66-4848VB	48	5	48	-	-	150	11.0	T\$ 1876 TXT\$ 2345

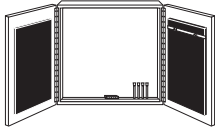
Description

- Tackboard on Each Door is Standard in Black Fabric Unless Specified
- Price Valid for Fabric Grades 1, 2, and 3
- Display Rail with Adjustable Hooks for Flipchart
- Flipchart
- Magnetic Porcelain Non-Glare Writing Surface
- Set of Four Dry Markers and Eraser
- Shipped with Appropriate Rails for Mounting

Options: Specify & Add	Grade 4	Grade 5	Grade 6	Grade 7	Grade 8	Grade 9	Grade 10
Tackboard	\$ 181	\$ 263	\$ 354	\$ 473	\$ 601	\$ 753	\$ 926
1-PS Optional Factory Installed Projection Screen							\$ 667



NOTE: A capsule pull will be substituted for Elite, Buckle, or Groove pulls.
 NOTE: Indiana Furniture will not be liable for visual boards that are not properly installed.

WARDROBE/STORAGE CABINET	Model No.	W	D	H	K	R	Ship Wt	Cubic Ft	List Price
	66-3672WC	36	24	70 7/8	-	-	290	42.0	T\$ 1929 TXT\$ 2411
	66-3072WC	30	24	70 7/8	-	-	240	35.7	T\$ 1878 TXT\$ 2347

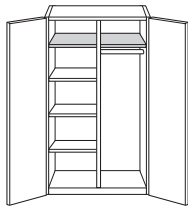
Description

- Storage Behind Two Doors
- Fixed Top Shelf
- Three Adjustable Shelves on Left Side
- Coat Rod on Right Side

Options: Specify & Add

1-LOCK Optional Locking	\$ 58
-------------------------	-------



NOTE: A capsule pull will be substituted for Elite, Buckle, or Groove pulls.

For ordering options, see back of Canvas Identification card at the beginning of section.

Item	Model No.	W	D	H	K	R	Ship Wt	Cubic Ft	List Price
1/4 ROUND BOOKCASE	66-1472QR	14	14	70 7/8	-	-	130	10.8	T\$ 801 TXT\$ 1000

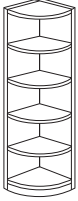
Description

- Four Fixed Shelves
- Must Not be Used as Freestanding

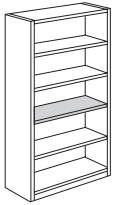
BOOKCASES

66-3672BC	36	14 1/4	70 7/8	-	-	176	26.9	T\$ 1234 TXT\$ 1542	
Three Adjustable Shelves - One Fixed Shelf									
66-3072BC	30	14 1/4	70 7/8	-	-	146	23.3	T\$ 1010 TXT\$ 1263	
Three Adjustable Shelves - One Fixed Shelf									
66-3660BC	36	14 1/4	58 7/8	-	-	147	23.2	T\$ 1063 TXT\$ 1329	
Three Adjustable Shelves									
66-3060BC	30	14 1/4	58 7/8	-	-	122	19.5	T\$ 885 TXT\$ 1106	
Three Adjustable Shelves									
66-3648BC	36	14 1/4	46 7/8	-	-	120	18.7	T\$ 982 TXT\$ 1228	
Two Adjustable Shelves									
66-3048BC	30	14 1/4	46 7/8	-	-	100	15.7	T\$ 764 TXT\$ 954	
Two Adjustable Shelves									
66-3630BC	36	14 1/4	30	-	-	75	11.9	T\$ 744 P\$ 836 TXT\$ 930	
One Adjustable Shelf Top - Profiled on Front Edge									
66-3030BC	30	14 1/4	30	-	-	62	10.1	T\$ 628 P\$ 716 TXT\$ 784	
One Adjustable Shelf Top - Profiled on Front Edge									

Description

- 1" Thick Shelves

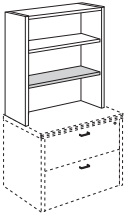
TOP UNIT BOOKCASE

66-1536TU	36	14 1/4	40 7/8	-	-	98	15.9	T\$ 680 TXT\$ 851	
One Adjustable Shelf									
66-1530TU	30	14 1/4	40 7/8	-	-	127	16.4	T\$ 628 TXT\$ 784	
One Adjustable Shelf									

Description

- Fixed Bottom Shelf with 12" Clearance
- For Use on Two Drawer Lateral Files
- 1" Thick Shelves

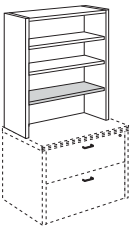
TALL TOP UNIT BOOKCASE

66-1536TTU	36	14 1/4	52 7/8	-	-	169	22.2	T\$ 859 TXT\$ 1074
66-1530TTU	30	14 1/4	52 7/8	-	-	141	17.3	T\$ 783 TXT\$ 980

Description

- One Fixed Shelf
- Two Adjustable Shelves

For ordering options, see back of Canvas Identification card at the beginning of section.

Item	Model No.	W	D	H	K	R	Ship Wt	Cubic Ft	List Price
STORAGE CABINET WITH LATERAL FILES	66-3672SU1	36	24	70 7/8	-	-	298	42.0	T\$ 2341 TXT\$ 2926
	66-3072SU1	30	24	70 7/8	-	-	251	35.7	T\$ 2286 TXT\$ 2858

Description

- Top - Two Doors with Two Adjustable Shelves
- Bottom - File/File
- Locking Drawers
- File Drawers Provide Legal or Letter Filing

NOTE: A capsule pull will be substituted on upper doors for Elite, Buckle, or Groove pulls.

BUFFET CREDENZA	66-2472BF	72	24	36	-	-	342	45.5	T\$ 2294 P\$ 2454 TXT\$ 2867
-----------------	-----------	----	----	----	---	---	-----	------	------------------------------------

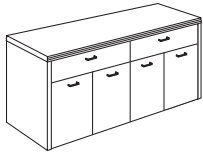
Description

- Two Drawers
- Storage Behind Doors
- Two Adjustable Shelves

SECRET TABLE PENINSULA	TFL/Textured	HPL	W	D	H	K	R	Ship Wt	Cubic Ft	List Price
	01-3660R96	01-3660R96H	60-96	36	30	-	-	145	43.6	T\$ 3639 P\$ 3870 TXT\$ 3783
Expands 36"										
01-3648R72	01-3648R72H	48-72	36	30	-	-	113	35.2	T\$ 3503 P\$ 3699 TXT\$ 3626	
Expands 24"										
01-3060R96	01-3060R96H	60-96	30	30	-	-	120	36.7	T\$ 3535 P\$ 3808 TXT\$ 3669	
Expands 36"										
01-3048R72	01-3048R72H	48-72	30	30	-	-	94	29.6	T\$ 3402 P\$ 3585 TXT\$ 3517	
Expands 24"										

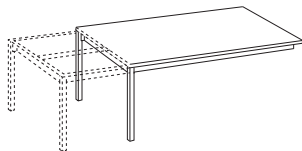
Description

- Aluminum Metal Frame with Aprons
- Expands to Reveal a Hidden Table Leaf
- 3/4" Thick Top with a Self Edge
- Concealed Casters
- Attaches to Fixed Worksurfaces to Create a Run-Off Peninsula Work Table

SECRET TABLE FREE STANDING	TFL/Textured	HPL	W	D	H	K	R	Ship Wt	Cubic Ft	List Price
	01-3660T96	01-3660T96H	60-96	36	30	-	-	150	43.6	T\$ 4460 P\$ 4691 TXT\$ 4604
Expands 36"										
01-3060T96	01-3060T96H	60-96	30	30	-	-	125	36.7	T\$ 4337 P\$ 4553 TXT\$ 4472	
Expands 36"										

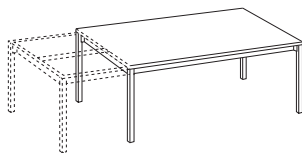
Description

- Aluminum Metal Frame with Aprons
- Expands to Reveal a Hidden Table Leaf
- 3/4" Thick Top with a Self Edge
- Adjustable Glides on Static Legs and Concealed Casters on Expanding End
- Freestanding Desk or Table

For ordering options, see back of Canvas Identification card at the beginning of section.

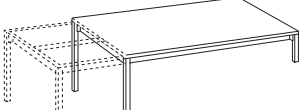
Item	Model No.	W	D	H	K	R	Ship Wt	Cubic Ft	List Price
SECRET TABLE FOR BENCHING 	TFL/Textured	HPL							
	01-3660LT96	60-96	36	30	-	-	148	43.6	T\$ 4216 P\$ 4447 TXT\$ 4360
	Expands 36"								
	01-3060LT96	60-96	30	30	-	-	123	36.7	T\$ 4100 P\$ 4316 TXT\$ 4234
Expands 36"									

Description

- Aluminum Metal Frame with Aprons
- Expands to Reveal a Hidden Table Leaf
- 3/4" Thick Top with a Self Edge
- Concealed Casters
- Installs Over Benching Units Created with Canvas or Gesso Components

COMPUTER WORK TABLE 	66-2442CW	42	24	27	-	-	115	19.2	T\$ 791 P\$ 906 TXT\$ 990
	66-2436CW	36	24	27	-	-	99	16.6	T\$ 777 P\$ 878 TXT\$ 970

Description

- Fixed Shelf
- Grommet in Back Panel

Options: Specify & Add

CS-66BL	Optional Black Casters	\$ 150
---------	------------------------	--------

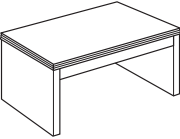
MAGAZINE TABLE 	66-2442MT	42	24	16	-	-	70	11.9	T\$ 657 P\$ 770 TXT\$ 820
--	-----------	----	----	----	---	---	----	------	---------------------------------

Description

- Slab Ends
- Apron Rail

END TABLE 	66-2424ET	24	24	22	-	-	65	9.4	T\$ 624 P\$ 716 TXT\$ 779
---	-----------	----	----	----	---	---	----	-----	---------------------------------

Description

- Slab Ends
- Apron Rail

For ordering options, see back of Canvas Identification card at the beginning of section.

Item	Model No.	W	D	H	K	R	Ship Wt	Cubic Ft	List Price
CIRCULAR TABLE 	66-4848CT Accommodates 5 Chairs	48	48	1	-	-	95	4.3	T\$ 496 P\$ 695 TXT\$ 620
	66-4242CT Accommodates 4 Chairs	42	42	1	-	-	70	3.4	T\$ 480 P\$ 671 TXT\$ 599
	66-3636CT Accommodates 3 Chairs	36	36	1	-	-	37	2.5	T\$ 420 P\$ 588 TXT\$ 525

Description

- Single Base Required

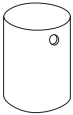

CYLINDER BASE 	01-2020CB For Use with 48" and 42" Circular Tables	20	20	28 1/2	-	-	136	10.8	T\$ 977
	01-1616CB For Use with 36" Circular Table	16	16	28 1/2	-	-	101	7.2	T\$ 892

Description

- Veneer Cylinder Base
- Weighted for Stability
- Not Available in LG, WH, SG, TK, XU or Any Textured Laminates
- 2 Wire Management Grommets Standard at Top with 8" Opening Standard in Bottom

Options: Specify & Add

GCBIS	Optional Grommet Top Edge (1)	\$	N/C
NOGC	Optional No Grommets At Top Edges	\$	N/C

METAL BASE  Open Market Only 	01-0400MBB Black Metal Base	32	32	27 3/4	-	-	32	3.2	T\$ 632
	01-0400MBA Aluminum Metal Base	32	32	27 3/4	-	-	32	3.2	T\$ 632

Description

- Shipped KD - Some Assembly Required
- Can be Used with 42" or 36" Circular Tables

NOTE: For 48" Tops, use 01-0404MB, see Resilience Casegood Series

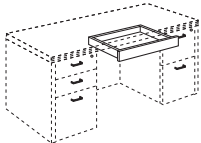
CENTER DRAWER 	66-1622CD	22	16	2	-	-	7	1.4	T\$ 270 TXT\$ 338
--	-----------	----	----	---	---	---	---	-----	----------------------

Description

- Fits Desks, P-Top Units, and D-Top Units
- Will Not Work in Conjunction with Modesty Panels on 30" D-Top Units

Options: Specify & Add

Factory Installed	\$	130
-------------------	----	-----

For ordering options, see back of Canvas Identification card at the beginning of section.

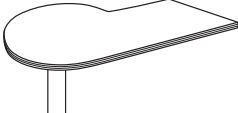
Item	Model No.	W	D	H	K	R	Ship Wt	Cubic Ft	List Price	
P-TOP PENINSULA WITH CYLINDER BASE 	Left Top	Right Top								
	66-4284TL	66-4284TR	84	42-36	30	-	-	120	13.2	T\$ 1385 P\$ 1840 TXT\$ 1732
	66-4272TL	66-4272TR	72	42-36	30	-	-	115	11.3	T\$ 1135 P\$ 1490 TXT\$ 1419

Description

- Metal Cylinder Base Standard - 4" Diameter. Must Specify: Black or Aluminum.
- Shipped KD
- 48" Stiffener Bar Required on 84" Units if Used as Runoff
- Component Pedestals Cannot be Used in Combination with Sit-to-Stand Option

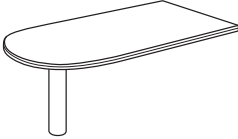
D-TOP PENINSULA WITH CYLINDER BASE 	66-3684DR	84	36	30	-	-	134	13.2	T\$ 1358 P\$ 1803 TXT\$ 1699
	66-3672DR	72	36	30	-	-	115	9.8	T\$ 1146 P\$ 1506 TXT\$ 1434
	66-3066DR	66	30	30	-	-	120	7.5	T\$ 1102 P\$ 1444 TXT\$ 1378

Description

- Metal Cylinder Base Standard - 4" Diameter. Must Specify: Black or Aluminum.
- Shipped KD
- 48" Stiffener Bar Required on 84" Units if Used as Runoff
- Component Pedestals Cannot be Used in Combination with Sit-to-Stand Option

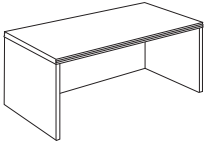
DESK SHELL 	66-3672SH	72	36	30	-	10 1/8	200	52.1	T\$ 1164 P\$ 1359 TXT\$ 1455
--	-----------	----	----	----	---	--------	-----	------	------------------------------------

Description

- For Use with or without Modular Pedestals
- Recessed Front
- Sit-to-Stand Option Available, See Page 36

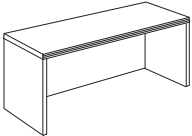
CREDENZA SHELL 	66-2472SH	72	24	30	-	-	135	35.6	T\$ 1009 P\$ 1169 TXT\$ 1262
--	-----------	----	----	----	---	---	-----	------	------------------------------------

Description

- For Use with or without Modular Pedestals
- Sit-to-Stand Option Available, See Page 36

For ordering options, see back of Canvas Identification card at the beginning of section.

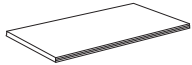
Item	Model No.	W	D	H	K	R	Ship Wt	Cubic Ft	List Price
 MODULAR DESK TOPS	66-3672TP	72	36	1	-	-	115	6.2	T\$ 491 P\$ 686 TXT\$ 613
	66-3072TP	72	30	1	-	-	85	4.6	T\$ 459 P\$ 641 TXT\$ 573
	66-3066TP	66	30	1	-	-	80	4.2	T\$ 442 P\$ 617 TXT\$ 553
	66-3060TP	60	30	1	-	-	75	3.8	T\$ 407 P\$ 570 TXT\$ 508

Description

- For Use as a Desk Top
- Profiled on Approach and User Side
- For Power and Data, See 1-DPORT4 on Page 89
- Stiffener Bar (Page 88) Recommended for Peninsula Application

Item	Model No.	W	D	H	K	R	Ship Wt	Cubic Ft	List Price
 MODULAR CABINET TOPS	66-24108TP	108	24	1	-	-	106	6.6	T\$ 496 P\$ 695
	66-24102TP	102	24	1	-	-	104	6.3	T\$ 485 P\$ 678
	66-2496TP	96	24	1	-	-	100	5.0	T\$ 473 P\$ 664 TXT\$ 593
	66-2490TP	90	24	1	-	-	95	4.6	T\$ 462 P\$ 646 TXT\$ 577
	66-2484TP	84	24	1	-	-	90	4.3	T\$ 423 P\$ 594 TXT\$ 529
	66-2478TP	78	24	1	-	-	85	4.0	T\$ 414 P\$ 578 TXT\$ 518
	66-2472TP	72	24	1	-	-	80	3.7	T\$ 402 P\$ 563 TXT\$ 503
	66-2466TP	66	24	1	-	-	75	3.4	T\$ 384 P\$ 536 TXT\$ 481
	66-2460TP For Front to Back Grain Use 66-6024TP	60	24	1	-	-	70	3.0	T\$ 366 P\$ 515 TXT\$ 459
	66-2454TP For Front to Back Grain Use 66-5424TP	54	24	1	-	-	65	2.8	T\$ 336 P\$ 470 TXT\$ 420
	66-2448TP For Front to Back Grain Use 66-4824TP	48	24	1	-	-	55	2.5	T\$ 312 P\$ 436 TXT\$ 390
	66-2442TP For Front to Back Grain Use 66-4224TP	42	24	1	-	-	50	2.2	T\$ 284 P\$ 397 TXT\$ 355
	66-2436TP For Front to Back Grain Use 66-3624TP	36	24	1	-	-	45	2.0	T\$ 250 P\$ 351 TXT\$ 313
	66-2430TP For Front to Back Grain Use 66-3024TP	30	24	1	-	-	36	1.6	T\$ 242 P\$ 339 TXT\$ 303
	66-2418TP	18	24	1	-	-	28	1.0	T\$ 223 P\$ 313 TXT\$ 280

Description

- For Use as a Bridge, Return or Credenza Top
- Profiled on User/Front Edge Only
- If Modular Tops will have a Kneespace Area of 60" or Greater, a Support Panel is Required, See Page 85
- Stiffener Bar may be Required

Item	Model No.	W	D	H	K	R	Ship Wt	Cubic Ft	List Price
MODULAR PEDESTAL BOX/BOX/FILE 	66-3618PD1	18	35 1/4	28 1/4	-	-	125	13.6	T\$ 978
	Use with Component Tops								
	66-3018PD1	18	29 1/4	28 1/4	-	-	105	11.6	T\$ 906
	Use with Component Tops and Shells								
	66-2515SHPD1	15 3/4	25	28 1/4	-	-	96	8.4	T\$ 772
	Use with 66-3672SH								
	66-2415PD1	15 3/4	23 1/4	28 1/4	-	-	93	7.8	T\$ 801
Use with Component Tops and Shells									
	66-2418PD1	18	23 1/4	28 1/4	-	-	98	8.9	T\$ 845
Use with Component Tops and Shells									

Description

- Modular Pedestal
- Box/Box/File Pedestal
- Open Back
- Top is Required
- Letter Width Locking Pedestal

Item	Model No.	W	D	H	K	R	Ship Wt	Cubic Ft	List Price
MODULAR PEDESTAL FILE/FILE 	66-3618PD2	18	35 1/4	28 1/4	-	-	125	13.6	T\$ 978
	Use with Component Tops								
	66-3018PD2	18	29 1/4	28 1/4	-	-	105	11.6	T\$ 906
	Use with Component Tops and Shells								
	66-2515SHPD2	15 3/4	25	28 1/4	-	-	96	8.4	T\$ 772
	Use with 66-3672SH								
	66-2415PD2	15 3/4	23 1/4	28 1/4	-	-	93	7.8	T\$ 801
Use with Component Tops and Shells									
	66-2418PD2	18	23 1/4	28 1/4	-	-	98	8.9	T\$ 845
Use with Component Tops and Shells									

Description

- Modular Pedestal
- File/File Pedestal
- Open Back
- Top is Required
- Letter Width Locking Pedestal

Item	Left	Right	W	D	H	K	R	Ship Wt	Cubic Ft	List Price
MODULAR PEDESTAL DOOR BOOKCASE 	66-2418PD4L	66-2418PD4R	18	23 1/4	28 1/4	-	-	90	8.9	T\$ 680
									TXT\$	851

Description

- Modular Pedestal
- Adjustable Shelf
- Open Back
- Top is Required

For ordering options, see back of Canvas Identification card at the beginning of section.

Item	Model No.	W	D	H	K	R	Ship Wt	Cubic Ft	List Price	
MODULAR PEDESTAL OPEN MULTI-FILE	66-2436OMF	36	23 1/4	28 1/4	-	-	118	14.9	T\$	1113
									TXT\$	1391
	66-2430OMF	30	23 1/4	28 1/4	-	-	128	18.5	T\$	1068
									TXT\$	1336

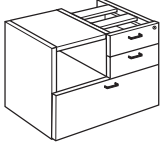
Description

- Upper Section Provides 12 3/4" Clearance for Open Storage and Two Box Drawers
- Lateral File in Lower Section Provides Legal or Letter Filing
- Locking

MODULAR PEDESTAL LATERAL FILE	66-2436LF1	36	23 1/4	28 1/4	-	-	154	18.5	T\$	1009
									TXT\$	1262
	66-2430LF1	30	23 1/4	28 1/4	-	-	128	14.9	T\$	938
									TXT\$	1172

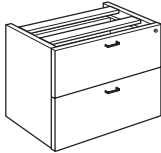
Description

- Modular Pedestal for 24" Deep Tops
- Open Back
- Top is Required
- Locking
- Legal or Letter Filing Front to Back or Side to Side

MODULAR PEDESTAL MULTI-FILE	66-2436LF2	36	23 1/4	28 1/4	-	-	153	18.5	T\$	1158
									TXT\$	1447
	66-2430LF2	30	23 1/4	28 1/4	-	-	128	14.9	T\$	1114
									TXT\$	1392

Description

- Modular Pedestal for 24" Deep Tops
- Locking File Drawers Only
- Open Back
- Top is Required

For ordering options, see back of Canvas Identification card at the beginning of section.

Item	Model No.	W	D	H	K	R	Ship Wt	Cubic Ft	List Price	
MODULAR PEDESTAL DOOR BOOKCASE	66-2436DB	35	23 1/4	28 1/4	-	-	105	18.5	T\$	957
									TXT\$	1197
	66-2430DB	30	23 1/4	28 1/4	-	-	87	14.9	T\$	756
									TXT\$	947

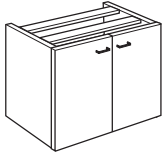

Description

- Modular Pedestal for 24" Deep Tops
- Open Back
- Top is Required
- Adjustable Shelf Behind Doors

Options: Specify & Add

1-LOCK	Optional Door Lock	\$	58
--------	--------------------	----	----

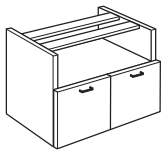
MODULAR PEDESTAL DOOR BOOKCASE W/OPEN COMPARTMENT	66-2436ODB	36	23 1/4	28 1/4	-	-	108	14.9	T\$	904
									TXT\$	1130
	66-2430ODB	30	23 1/4	28 1/4	-	-	118	18.5	T\$	699
									TXT\$	874

Description

- Upper Section Provides 12 3/4" Clearance for Open Storage
- Lower Section Provides Storage Behind Two Doors

MODULAR PEDESTAL OPEN STORAGE	66-2436MBC	36	22 15/32	28 1/4	-	-	108	14.9	T\$	781
									TXT\$	977
	66-2430MBC	30	22 15/32	28 1/4	-	-	118	18.5	T\$	664
									TXT\$	829

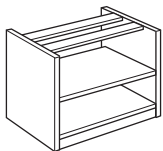
Description

- One Adjustable Shelf

For ordering options, see back of Canvas Identification card at the beginning of section.

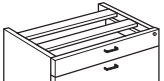
Item	Model No.	W	D	H	K	R	Ship Wt	Cubic Ft	List Price
LOW HEIGHT MODULAR PEDESTAL TRAY/FILE 	66-2436LTF	36	23 1/4	16 1/4	-	-	115	10.3	T\$ 799 TXT\$ 997
	66-2430LTF	30	23 1/4	16 1/4	-	-	96	8.6	T\$ 767 TXT\$ 958
	66-2418LTF	18	23 1/4	16 1/4	-	-	48	5.4	T\$ 650 TXT\$ 814

Description

- For Low Height Credenzas or Benching Applications
- Locking Tray/File
- File Drawer Provides Legal or Letter Filing

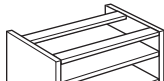
LOW HEIGHT MODULAR PEDESTALS OPEN STORAGE 	66-2436LBC	36	22 15/32	16 1/4	-	-	115	10.3	T\$ 655 TXT\$ 819
	66-2430LBC	30	22 15/32	16 1/4	-	-	96	8.6	T\$ 633 TXT\$ 790
	66-2418LBC	18	22 15/32	16 1/4	-	-	48	5.4	T\$ 576 TXT\$ 720

Description

- For Low Height Credenzas or Benching Applications
- One Adjustable Shelf

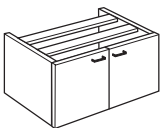
LOW HEIGHT MODULAR PEDESTAL DOOR BOOKCASES 	66-2436LDB	36	23 1/4	16 1/4	-	-	115	10.3	T\$ 747 TXT\$ 933
	66-2430LDB	30	23 1/4	16 1/4	-	-	96	8.6	T\$ 667 TXT\$ 833

Description

- For Low Height Credenzas or Benching Applications

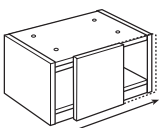
LOW HEIGHT MODULAR PEDESTAL SLIDING DOOR BOOKCASES 	66-2436LSD	36	23 1/4	16 1/4	-	-	115	10.3	T\$ 855 TXT\$ 1069
	66-2430LSD	30	23 1/4	16 1/4	-	-	96	8.6	T\$ 751 TXT\$ 939

Description

- For Low Height Credenzas or Benching Applications
- Storage Behind Sliding Door

For ordering options, see back of Canvas Identification card at the beginning of section.

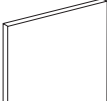
Item	Model No.	W	D	H	K	R	Ship Wt	Cubic Ft	List Price
SEATED HEIGHT MODULAR PENINSULA SUPPORT 	66-3630EP	36	1	28 1/4	-	-	40	2.0	T\$ 270 TXT\$ 338
	66-3030EP	30	1	28 1/4	-	-	34	1.6	T\$ 255 TXT\$ 319
	66-2812SP	12	1	28 1/4	-	-	12	.8	T\$ 167 TXT\$ 208

Description

- To Be Used with Modular Desk Tops at 30" High
- Required to Be Used with T Support or the Support Panel Perpendicular to 36" and 30" Unit

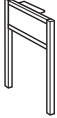
SEATED HEIGHT MODULAR PENINSULA SUPPORT 	01-3628HL Single Mount Plate	36	1	28 1/4	-	-	30	2.0	\$ 680
	01-3028HL Single Mount Plate	30	1	28 1/4	-	-	25	1.7	\$ 669
	01-2428HL Single Mount Plate	24	1	28 1/4	-	-	20	1.4	\$ 502
	01-3628TL Double Mount Plate	36	1	28 1/4	-	-	30	2.0	\$ 702
	01-3028TL Double Mount Plate	30	1	28 1/4	-	-	25	1.7	\$ 690
	01-2428TL Double Mount Plate	24	1	28 1/4	-	-	20	1.4	\$ 519

Description

- Metal End Support to Be Used with Modular Desk Tops at 30" High
- Select From 5 Powdercoat Finishes
- Double Mount Plate Required for Freestanding Table/Desk

Options: Specify & Add

HIM	Laminate Insert	T\$ 42
		TXT\$ 52

SEATED HEIGHT MODULAR PENINSULA SUPPORT 	01-3628OL	36	2	28 1/4	-	-	30	2.7	\$ 698
	01-3028OL	30	2	28 1/4	-	-	25	2.3	\$ 681
	01-2428OL	24	2	28 1/4	-	-	20	1.8	\$ 667

Description

- Metal End Support to Be Used with Modular Desk Tops at 30" High
- Select From 5 Powdercoat Finishes

SEATED HEIGHT MODULAR PENINSULA SUPPORT 	01-3628UL	36	2	28 1/4	-	-	30	2.7	\$ 739
	01-3028UL	30	2	28 1/4	-	-	25	2.3	\$ 726
	01-2428UL	24	2	28 1/4	-	-	20	1.8	\$ 710

Description

- Metal End Support to Be Used with Modular Desk Tops at 30" High
- Select From 5 Powdercoat Finishes

For ordering options, see back of Canvas Identification card at the beginning of section.

Item	Model No.	W	D	H	K	R	Ship Wt	Cubic Ft	List Price
STANDING HEIGHT MODULAR PENINSULA SUPPORT	01-3639HL	36	1	40 1/4	-	-	30	2.7	\$ 721
	01-3039HL	30	1	40 1/4	-	-	25	2.3	\$ 709
	01-2439HL	24	1	40 1/4	-	-	20	1.9	\$ 695

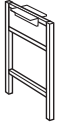

Description

- Metal End Support to Be Used with Modular Desk Tops at 41" High
- Select From 5 Powdercoat Finishes
- Not to Be Used to Create a Freestanding Table Desk

Options: Specify & Add

HIM	Laminate Insert	T\$	42
		TXT\$	52

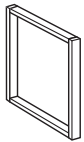
STANDING HEIGHT MODULAR PENINSULA SUPPORT	01-3639OL	36	2	40 1/4	-	-	30	3.6	\$ 723
	01-3039OL	30	2	40 1/4	-	-	25	3.1	\$ 711
	01-2439OL	24	2	40 1/4	-	-	20	2.5	\$ 696

Description

- Metal End Support to Be Used with Modular Desk Tops at 41" High
- Select From 5 Powdercoat Finishes
- Not to Be Used to Create a Freestanding Table Desk

STANDING HEIGHT MODULAR PENINSULA SUPPORT	01-3639UL	36	2	40 1/4	-	-	30	3.6	\$ 769
	01-3039UL	30	2	40 1/4	-	-	25	3.1	\$ 754
	01-2439UL	24	2	40 1/4	-	-	20	2.5	\$ 739

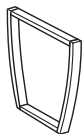
Description

- Metal End Support to Be Used with Modular Desk Tops at 41" High
- Select From 5 Powdercoat Finishes
- Not to Be Used to Create a Freestanding Table Desk

Item	Model No.	W	D	H	K	R	Ship Wt	Cubic Ft	List Price
LAYER SUPPORT OVER LOW HEIGHT CABINETS	66-1811USP	18	5 3/4	11	-	-	20	1.2	T\$ 224 TXT\$ 281

Description

- Supports 30" High Worksurfaces that Overlap Low Height Components
- Open Throughout and On Back Side to Manage Cables

O METAL LAYER SUPPORT OVER LOW HEIGHT CABINETS	01-2411OL	24	2	11	-	-			\$ 641
	01-3011OL	30	2	11	-	-			\$ 655
	01-3611OL	36	2	11	-	-			\$ 667



Description

- Supports 30" High Worksurfaces Over Low Height Components
- Select From 5 Powdercoat Finishes

U METAL LAYER SUPPORT OVER LOW HEIGHT CABINETS	01-2411UL	24	2	11	-	-			\$ 672
	01-3011UL	30	2	11	-	-			\$ 686
	01-3611UL	36	2	11	-	-			\$ 699

Description

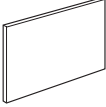
- Supports 30" High Worksurfaces Over Low Height Components
- Select From 5 Powdercoat Finishes

Item	Model No.	W	D	H	K	R	Ship Wt	Cubic Ft	List Price
 MODULAR MODESTY PANEL	66-10828BP	108	3/4	28 1/4	-	-	130	5.7	T\$ 412
	66-10228BP	102	3/4	28 1/4	-	-	122	5.4	T\$ 391
	66-9628BP	96	3/4	28 1/4	-	-	115	5.0	T\$ 376 TXT\$ 469
	66-9028BP	90	3/4	28 1/4	-	-	108	4.6	T\$ 365 TXT\$ 457
	66-8428BP	84	3/4	28 1/4	-	-	101	4.3	T\$ 353 TXT\$ 440
	66-7828BP	78	3/4	28 1/4	-	-	94	4.0	T\$ 344 TXT\$ 429
	66-7228BP	72	3/4	28 1/4	-	-	86	3.7	T\$ 333 TXT\$ 418
	66-6628BP	66	3/4	28 1/4	-	-	79	3.4	T\$ 324 TXT\$ 405
	66-6028BP	60	3/4	28 1/4	-	-	72	3.0	T\$ 318 TXT\$ 397
	66-5428BP	54	3/4	28 1/4	-	-	65	2.8	T\$ 303 TXT\$ 378
	66-4828BP	48	3/4	28 1/4	-	-	55	2.5	T\$ 290 TXT\$ 363
	66-4228BP	42	3/4	28 1/4	-	-	50	2.2	T\$ 252 TXT\$ 316
	66-3628BP	36	3/4	28 1/4	-	-	45	2.0	T\$ 217 TXT\$ 272
	66-3028BP	30	3/4	28 1/4	-	-	30	1.6	T\$ 199 TXT\$ 248
	66-1828BP	18	3/4	28 1/4	-	-	19	1.0	T\$ 171 TXT\$ 213
	66-1528BP	15 3/4	3/4	28 1/4	-	-	18	1.0	T\$ 156 TXT\$ 197

Description

- For Use as a Modesty Panel to Create Bridges, Returns, or Credenzas
- Grain Runs Vertically Up to 60" - All Larger Sizes are Horizontal Grain Patterns

Options: Specify & Add

1-GRMT	Optional Top-Center Grommet	\$ 48
--------	-----------------------------	-------

 FILLER PANEL	66-2803FP	3	3/4	28 1/4	-	-	6	.5	T\$ 135 TXT\$ 169
--	-----------	---	-----	--------	---	---	---	----	----------------------

Description

- Used to Fill Gap Behind Modular Pedestals

For ordering options, see back of Canvas Identification card at the beginning of section.

Item	Model No.	W	D	H	K	R	Ship Wt	Cubic Ft	List Price
LOW HEIGHT BACK PANEL 	66-10816BP	108	3/4	16 1/4	-	-	75	3.4	T\$ 342
	66-10216BP	102	3/4	16 1/4	-	-	70	3.3	T\$ 328
	66-9616BP	96	3/4	16 1/4	-	-	65	3.2	T\$ 309 TXT\$ 386
	66-9016BP	90	3/4	16 1/4	-	-	60	3.1	T\$ 303 TXT\$ 378
	66-8416BP	84	3/4	16 1/4	-	-	55	3.0	T\$ 294 TXT\$ 368
	66-7816BP	78	3/4	16 1/4	-	-	50	2.9	T\$ 279 TXT\$ 349
	66-7216BP	72	3/4	16 1/4	-	-	45	2.8	T\$ 269 TXT\$ 334
	66-6616BP	66	3/4	16 1/4	-	-	40	2.7	T\$ 260 TXT\$ 326
	66-6016BP	60	3/4	16 1/4	-	-	35	2.6	T\$ 216 TXT\$ 271
	66-5416BP	54	3/4	16 1/4	-	-	30	2.5	T\$ 203 TXT\$ 253
	66-4816BP	48	3/4	16 1/4	-	-	25	2.4	T\$ 199 TXT\$ 248
	66-4216BP	42	3/4	16 1/4	-	-	20	2.3	T\$ 187 TXT\$ 235
	66-3616BP	36	3/4	16 1/4	-	-	15	2.2	T\$ 181 TXT\$ 226
	66-3016BP	30	3/4	16 1/4	-	-	10	2.1	T\$ 173 TXT\$ 216
	66-1816BP	18	3/4	16 1/4	-	-	5	2.0	T\$ 153 TXT\$ 191

Description

- For Use as a Modesty Panel to Create Low Height Returns, Credenzas, or Benches
- Grain Runs Vertically Up to 60" - All Larger Sizes are Horizontal Grain Patterns

LOW HEIGHT FILLER PANEL 	66-1603FP	3	3/4	16 1/4	-	-	4	.9	T\$ 119 TXT\$ 149
--	-----------	---	-----	--------	---	---	---	----	----------------------

Description

- For Low Height Credenzas or Benching Applications
- Used to Fill Gap Behind Modular Pedestals

For ordering options, see back of Canvas Identification card at the beginning of section.

Item	Model No.	W	D	H	K	R	Ship Wt	Cubic Ft	List Price
FLIPDOWN MODESTY PANEL	66-2836FDM	36	3 1/2	28 1/4	-	-	35	3.3	T\$ 613 TXT\$ 768
	66-2830FDM	30	3 1/2	28 1/4	-	-	30	2.7	T\$ 542 TXT\$ 678

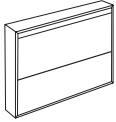
Description

- Modesty Panel with 3" Deep Case Allows Room for Plugs
- Upper Panel is Hinged and Opens Fully to Access Electrical and Data Ports
- Upper Panel is Open at Top for Easy Access and Cord Management

MODULAR END PANEL	66-3530EP	35 1/4	1	28 1/4	-	-	41	2.6	T\$ 268 TXT\$ 333
	66-2930EP	29 1/4	1	28 1/4	-	-	34	2.2	T\$ 253 TXT\$ 316
	66-2330EP	23 1/4	1	28 1/4	-	-	27	1.6	T\$ 239 TXT\$ 297

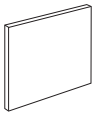
Description

- Required to Be Used with a Backpanel

SUPPORT PANEL	66-2812SP	12	1	28 1/4	-	-	12	.8	T\$ 167 TXT\$ 208
---------------	-----------	----	---	--------	---	---	----	----	----------------------

Description

- Required to be Used Perpendicular to Full Backpanels to Support Kneespace Areas of 60" or Longer

SUPPORT T	66-1010SP	10	10	28 1/4	-	-	20	.8	T\$ 242 TXT\$ 303
-----------	-----------	----	----	--------	---	---	----	----	----------------------

Description

- Supports Worksurfaces
- Required on Kneespace Areas of 60" or More Where Backpanels are Not Used

For ordering options, see back of Canvas Identification card at the beginning of section.

Item	Model No.	W	D	H	K	R	Ship Wt	Cubic Ft	List Price	
LOW HEIGHT END PANEL	66-2416EP	23 1/4	1	16 1/4	-	-	15	.8	T\$	197
									TXT\$	245

Description

- For Low Height Credenzas or Benching Applications
- End Panel for 24" Deep Worksurfaces
- Required to Be Used with a Backpanel

LOW HEIGHT SUPPORT PANEL	66-1612SP	12	1	16 1/4	-	-	7	.4	T\$	144
									TXT\$	180

Description

- Required to be Used Perpendicular to Full Backpanels to Support Kneespace Areas of 60" or Longer

LOW HEIGHT SUPPORT T	66-1610SP	10	10	16 1/4	-	-	11	2.3	T\$	200
									TXT\$	249

Description

- For Low Height Credenzas or Benching Applications
- Required to Be Used on Areas of 60" or Greater Where Backpanels are Not Used

For ordering options, see back of Canvas Identification card at the beginning of section.

Item	Model No.	W	D	H	K	R	Ship Wt	Cubic Ft	List Price
MODULAR TABLE DESK LEG WITH LEVELER	01-0401MLA Aluminum Leg	2	2	28 3/4	-	-	10	.5	\$ 203
	01-0401MLB Black Leg	2	2	28 3/4	-	-	10	.5	\$ 203

Description

- Adjustable Black Leveler

MODULAR TABLE DESK LEG WITH CASTER	01-0400MLA Aluminum Leg	2	2	28 3/4	-	-	10	.5	\$ 174
	01-0400MLB Black Leg	2	2	28 3/4	-	-	10	.5	\$ 174



Description

- Locking Black Casters

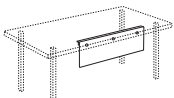
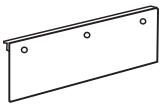
ACRYLIC PRIVACY PANEL OR MODESTY PANEL	66-1054PVS	54	1/4	10	-	-	10	1.2	\$ 504
	66-1042PVS	42	1/4	10	-	-	8	.9	\$ 434

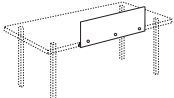

Modesty



Privacy

Description

- Install Downward for Modesty Panel
- Install Upward for Privacy Panel
- Attaches Below Worksurfaces
- Must Be Field Installed
- Ships KD - Some Assembly Required

For ordering options, see back of Canvas Identification card at the beginning of section.

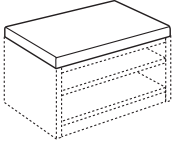
Item	Model No.	W	D	H	K	R	Ship Wt	Cubic Ft	List Price
	66-24108CUSHION	108	24	2 1/4	-	-	24	9.9	\$ 498
	66-2490CUSHION	90	24	2 1/4	-	-	22	8.3	\$ 451
	66-2472CUSHION	72	24	2 1/4	-	-	20	6.7	\$ 379
	66-2460CUSHION	60	24	2 1/4	-	-	18	5.6	\$ 329
	66-2436CUSHION	36	24	2 1/4	-	-	16	3.4	\$ 280
	66-2430CUSHION	30	24	2 1/4	-	-	14	2.9	\$ 242
	66-1519CUSHION	15	19	2 1/4	-	-	9	1.5	\$ 210

Description



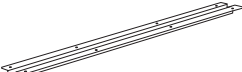

- Create Bench Style Seating Over Low Height Credenzas or Returns
- Must attach to a Modular Top, See Page 75
- Cushions are Shipped with Hardware for Both Fixed and Movable Applications
- Price is Valid for Fabric Grades 1, 2, and 3
- See Page 97 for Additional Fabric Grades

	01-00048SB	48	1 3/4	3/4	-	-	5	.3	\$ 163
	01-00060SB	60	1 3/4	3/4	-	-	8	.3	\$ 172

Description

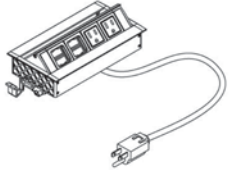
- Reinforces Worksurfaces with Large Kneespace Widths
- Field Installed
- Recommended in Kneespaces 60" or Greater

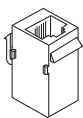
For ordering options, see back of Canvas Identification card at the beginning of section.

Item	Model No.	W	D	H	K	R	Ship Wt	Cubic Ft	List Price	
POWER DATA PORT 	01-DPORT4A Aluminum	8	4	-	-	-	7	.2	\$ 690	
	01-DPORT4B Black	8	4	-	-	-	7	.2	\$ 690	
Description <ul style="list-style-type: none"> Retracts into Work Surface to Regain Productive Space One-Touch Access to Power and Data Two Power Outlets and Two Open Ports for Data Water-Proof Simplex (Outlets) Includes a Voice/Data Adapter Kit to Accept Couplers and Jacks When Required 6' Power Cord Only Available on Modular Desktops (Page 75) Centered, One End 										
USB PORT 	01-USBPORT	-	-	-	-	-	-	-	\$ 102	
Description <ul style="list-style-type: none"> Increases Transfer Speed Up to 5 gbs/sec Simultaneous Read/Write Capability Idle Device Power Saving State 6' Cord 										
VOICE COUPLER 	01-VOICE1	-	-	-	-	-	-	-	\$ 46	
Description <ul style="list-style-type: none"> 6-Pin Modular Plug Molded Black Cord Not included 										
DATA PORT 	01-RJ4DATA	-	-	-	-	-	-	-	\$ 105	
Description <ul style="list-style-type: none"> 8-Pin Modular Plug Cat 5 Ethernet Cable Pre-terminated Cable 9' Cord 										

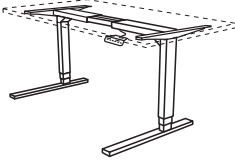
Item	Model No.	W	D	H	Ship Wt	Cubic Ft	List Price	
PNEUMATIC TABLE LIFT 	Silver	Black						
	01-2240PLS	01-2240PLB	36	22	26 - 45 1/2	66	2.3	\$ 3139
	Compatible with 24" Deep Tops that are 48" Long							
	01-2248PLS	01-2248PLB	44	22	26 - 45 1/2	68	2.3	\$ 3159
	Compatible with 24" Deep Tops that are 54" Long							
	01-2256PLS	01-2256PLB	52	22	26 - 45 1/2	70	2.5	\$ 3178
	Compatible with 24" Deep Tops that are 60" or 66" Long							
	01-2264PLS	01-2264PLB	60	22	26 - 45 1/2	71	2.8	\$ 3196
	Compatible with 24" Deep Tops that are 72" Long							
	01-2640PLS	01-2640PLB	36	22	26 - 45 1/2	66	2.3	\$ 3164
Compatible with 30" and 36" Deep Tops that are 48" Long								
01-2648PLS	01-2648PLB	44	22	26 - 45 1/2	68	2.3	\$ 3182	
Compatible with 30" and 36" Deep Tops that are 54" Long								
01-2656PLS	01-2656PLB	52	22	26 - 45 1/2	70	2.5	\$ 3200	
Compatible with 30" and 36" Deep Tops that are 60" or 66" Long								
01-2664PLS	01-2664PLB	60	22	26 - 45 1/2	71	2.8	\$ 3221	
Compatible with 30" and 36" Deep Tops that are 72" Long								

Description

- Pneumatic Lift Operates with Ease
- Stop at Any Position
- Height Adjustment from 26" to 46 1/2"
- Adjustable Levelers
- Tops Sold Separately
- Some Assembly Required
- Optional Grommets Must Be Field Installed

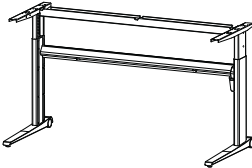
Item	Model No.	W	D	H	Ship Wt	Cubic Ft	List Price
ELECTRIC TABLE LIFT WITH CASTER 	Silver	Black					
	01-2861ELCS	01-2861ELCB	61 7/16	28 3/8	26 - 46 1/2	68	3
Compatible with 30" and 36" Deep Tops that are 72" - 84" Long							

Description

- Height Adjusts from 26" to 46 1/2" at 1" per Second
- Flip Out Tray Stores Cables Under the Desk Top
- Built In Casters Provide Mobility if Desired
- 176 lbs Maximum Load
- Tops Sold Separately
- Some Assembly Required
- Optional Battery Pack Available
- Optional Grommets Must Be Field Installed

Open Market Only

For ordering options, see back of Canvas Identification card at the beginning of section.

Item	Model No.	W	D	H	Ship Wt	Cubic Ft	List Price	
ELECTRIC TABLE LIFT	Silver	Black						
	01-2232ELS	01-2232ELB	32 7/8	22 1/16	21 1/4 - 46 7/8	57	3	\$ 2074
	Compatible with 24" and 30" Deep Tops that are 42" - 48" Long							
	01-2256ELS	01-2256ELB	56 11/16	22 1/16	21 1/4 - 46 7/8	65	3	\$ 2139
Compatible with 24" and 30" Deep Tops that are 60" - 72" Long								
01-2259ELS	01-2259ELB	59 13/16	22 1/16	21 1/4 - 46 7/8	66	3	\$ 2143	
Compatible with 24" and 30" Deep Tops that are 72" - 84" Long								



Open Market Only

Description

- Height Adjusts from 21 1/4" to 46 7/8" at 1.2" per Second
- 220 lbs Maximum Load
- Automatic Safety Stop
- Removable Top Bracket Allows Keyboard Installation
- Tops Sold Separately
- Some Assembly Required
- Optional Battery Pack Available
- Optional Grommets Must Be Field Installed

Options: Specify & Add

01-ELCASTERS							\$ 154
--------------	--	--	--	--	--	--	--------

ELECTRIC TABLE LIFT	Silver	Black					
	01-2445ELS	01-2445ELB	69 5/16 - 45 11/16	27 1/2	24 3/4 - 48 7/16	53	3
Compatible with 24" and 30" Deep Tops that are 60" - 84" Long							

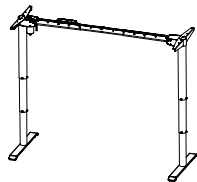

Open Market Only

Description

- Width Adjusts from 45 11/16" to 69 5/16" in Intervals of 3 5/16"
- Height Adjusts from 24 3/4" to 48 7/16" at 1.2" per Second
- 220 lbs Maximum Load
- Silver or Black with Inner Columns in Chrome
- Tops Sold Separately
- Some Assembly Required
- Optional Battery Pack Available
- Optional Grommets Must Be Field Installed

BATTERY PACK	01-BATTERYKIT	-	-	-	1	.5	\$ 879
--------------	---------------	---	---	---	---	----	--------



Open Market Only

Description

- 24 Volt Battery with Charger
- Works with Select Electric Table Lifts As Noted On Lift

For ordering options, see back of Canvas Identification card at the beginning of section.

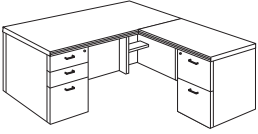
Item	Model No.	W	D	H	K	R	Ship Wt	Cubic Ft	List Price			
EXECUTIVE "L" UNIT 	66-1	72	84	30	-	-	481	73.1	T\$	2781		
									P\$	3103		
									TXT\$	3479		
Consists of:		Qty										
	68-3672LPS	1	• Single Left Pedestal Desk								T\$	1744
											P\$	1941
											TXT\$	2181
	68-2448RF2	1	• Right Return								T\$	1037
											P\$	1162
											TXT\$	1298

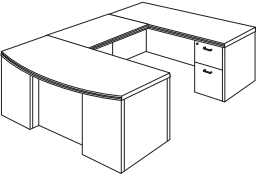
EXECUTIVE "U" UNIT BOW TOP DESK 	66-2	177	96	70.81	-	-	1418	214.3	T\$	3792		
									P\$	4279		
									TXT\$	4741		
Consists of:		Qty										
	68-3672BLPS	1	• Single Pedestal Desk								T\$	2013
											P\$	2213
											TXT\$	2516
	66-2448UF	1	• Bridge								T\$	473
											P\$	599
											TXT\$	593
	68-2472RC2	1	• Right Pedestal Credenza								T\$	1306
											P\$	1467
											TXT\$	1632

For ordering options, see back of Canvas Identification card at the beginning of section.

Item	Model No.	W	D	H	K	R	Ship Wt	Cubic Ft	List Price
EXECUTIVE CURVED "U" UNIT WITH SINGLE PED DESK	66-3	96	102	30	-	-	690	143.5	T\$ 4743
									P\$ 5304
									TXT\$ 5930

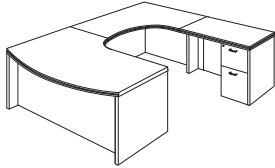
Consists of:
Qty

68-4872CBLP	1	• Executive Curved Left Pedestal Desk	T\$ 2157
			P\$ 2373
			TXT\$ 2696
66-4854ECCR	1	• Extended Corner Unit Right	T\$ 1549
			P\$ 1769
			TXT\$ 1936
68-4824RF2	1	• Extended Return Right	T\$ 1037
			P\$ 1162
			TXT\$ 1298

EXECUTIVE OFFICE	66-4	T\$ 10199
		P\$ 10556
		TXT\$ 12621

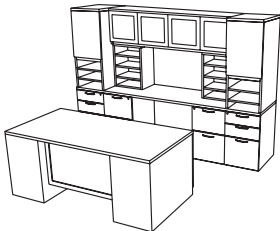
Consists of:
Qty

68-3672DPS	1	• Double Pedestal Desk with Laminate Framed Acrylic Modesty	T\$ 2423
			P\$ 2619
			TXT\$ 2975
68-2472KC	1	• Kneespace Credenza	T\$ 1826
			P\$ 1987
			TXT\$ 2283
66-1872DSIL	1	• Left Hinged Storage Cabinet Box/Box/File	T\$ 1655
			TXT\$ 2068
66-1872DSIR	1	• Right Hinged Storage Cabinet Box/Box/File	T\$ 1655
			TXT\$ 2068
66-1218HH	2	• Portable Paperslot Tower	T\$ 1124
			TXT\$ 1406
66-1572WD	1	• Wall Mount Hutch with Laminate Framed Acrylic Doors	T\$ 1516
			TXT\$ 1821

For ordering options, see back of Canvas Identification card at the beginning of section.

Item	Model No.	W	D	H	K	R	Ship Wt	Cubic Ft	List Price	
EXECUTIVE OFFICE	66-5								T\$ 8625	
									P\$ 8983	

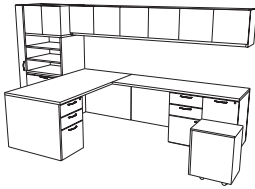

Consists of:	Qty								
68-3672LP	1	• Left Single Pedestal Desk	T\$ 1596						
			P\$ 1793						
66-2472RMR	1	• Right Multi-File Return	T\$ 1966						
			P\$ 2127						
66-3672WDS2	1	• Wardrobe/Storage Unit	T\$ 2282						
66-15108WD	1	• Wall Mount Hutch	T\$ 1952						
66-1519MP	1	• Mobile Pedestal	T\$ 829						

EXECUTIVE OFFICE	66-6								T\$ 9577	
									P\$ 10107	
									TXT\$ 11689	



Consists of:	Qty								
66-3672DUL	1	• Left Peninsula Desk with Silver Framed Modesty	T\$ 1719						
			P\$ 2078						
			TXT\$ 2064						
66-2484TP	1	• Modular Top	T\$ 423						
			P\$ 594						
			TXT\$ 529						
66-8428BP	1	• Modular Back Panel	T\$ 353						
			TXT\$ 440						
66-1584HU	1	• Surface Mount Hutch with Silver Framed Acrylic Doors	T\$ 2023						
			TXT\$ 2435						
66-1182PS	1	• Paperslots	T\$ 683						
			TXT\$ 854						
66-1536TUDB	1	• Top Unit Door Bookcase with Silver Framed Acrylic Doors	T\$ 1441						
			TXT\$ 1700						
66-2436OMF	1	• Modular Open Multi File	T\$ 1113						
			TXT\$ 1391						
66-1872DS1L	1	• Left Hinged Storage Cabinet File/File	T\$ 1655						
			TXT\$ 2068						
66-2812SP	1	• Support Panel	T\$ 167						
			TXT\$ 208						

For ordering options, see back of Canvas Identification card at the beginning of section.

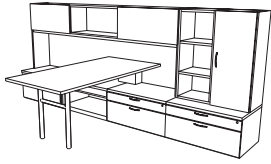
Item	Model No.	W	D	H	K	R	Ship Wt	Cubic Ft	List Price	
EXECUTIVE WORKSTATION	66-7	72	102	30	-	-	690	143.5	T\$ 9269 P\$ 9764	
	Consists of:	Qty								
	66-3672TP	1	• Modular Desk Top							T\$ 491 P\$ 686
	66-1811USP	1	• Desk Support Over Low Height Credenza							T\$ 224
	66-24108TP	1	• Modular Credenza Top							T\$ 496 P\$ 695
	66-2436TP	1	• Modular Credenza Top							T\$ 250 P\$ 351
	66-2436LTF	2	• Low Modular Storage							T\$ 1598
	66-2436LDB	1	• Low Modular Door Bookcase							T\$ 747
	66-2436LBC	1	• Low Modular Bookcase							T\$ 655
	66-10816BP	1	• Low Modular Back Panel							T\$ 342
	66-3616BP	1	• Low Modular Back Panel							T\$ 181
	66-15108SHU	1	• Surface Mounted Hutch with Sliding Doors							T\$ 2515
	66-1518HB	1	• Open Bookcase Tower							T\$ 548
	66-1518HR3	1	• Right Hinged Door Bookcase Tower							T\$ 720
	01-2428HL	1	• Metal Peninsula Support							\$ 502

For ordering options, see back of Canvas Identification card at the beginning of section.

TACKBOARD: SURFACE MOUNTED HUTCHES - 23" TALL

Size	Model #	COM ydg	COM, Grade 1, 2 or 3 List Price	Grade 4 List Price	Grade 5 List Price	Grade 6 List Price	Grade 7 List Price	Grade 8 List Price	Grade 9 List Price	Grade 10 List Price
66"	TB-6666H	2.00	\$ 336	\$ 518	\$ 600	\$ 690	\$ 810	\$ 937	\$ 1090	\$ 1263
72"	TB-6672H	2.25	\$ 357	\$ 561	\$ 653	\$ 755	\$ 890	\$ 1033	\$ 1204	\$ 1399
78"	TB-6678H	2.50	\$ 397	\$ 624	\$ 726	\$ 840	\$ 989	\$ 1148	\$ 1339	\$ 1555
84"	TB-6684H	2.50	\$ 404	\$ 631	\$ 734	\$ 847	\$ 996	\$ 1156	\$ 1346	\$ 1562
90"	TB-6690H	2.75	\$ 425	\$ 674	\$ 787	\$ 912	\$ 1076	\$ 1251	\$ 1461	\$ 1698
96"	TB-6696H	3.00	\$ 446	\$ 717	\$ 841	\$ 977	\$ 1156	\$ 1347	\$ 1575	\$ 1835
102"	TB-66102H	3.25	\$ 461	\$ 755	\$ 889	\$ 1036	\$ 1230	\$ 1438	\$ 1685	\$ 1966
108"	TB-66108H	3.50	\$ 478	\$ 795	\$ 939	\$ 1098	\$ 1307	\$ 1530	\$ 1797	\$ 2099

NOTE: All tackboards 78" and longer are 2 pieces.

TACKBOARD: WALL MOUNTED HUTCHES - 23" TALL

Size	Model #	COM ydg	COM, Grade 1, 2 or 3 List Price	Grade 4 List Price	Grade 5 List Price	Grade 6 List Price	Grade 7 List Price	Grade 8 List Price	Grade 9 List Price	Grade 10 List Price
30"	TB-6630W	1.00	\$ 247	\$ 338	\$ 379	\$ 424	\$ 484	\$ 547	\$ 624	\$ 710
36"	TB-6636W	1.25	\$ 274	\$ 387	\$ 438	\$ 495	\$ 570	\$ 649	\$ 744	\$ 853
42"	TB-6642W	1.25	\$ 281	\$ 394	\$ 446	\$ 502	\$ 577	\$ 657	\$ 752	\$ 860
48"	TB-6648W	1.50	\$ 311	\$ 447	\$ 508	\$ 576	\$ 666	\$ 761	\$ 876	\$ 1005
54"	TB-6654W	1.75	\$ 340	\$ 498	\$ 570	\$ 649	\$ 754	\$ 865	\$ 999	\$ 1150
60"	TB-6660W	2.00	\$ 357	\$ 538	\$ 620	\$ 711	\$ 830	\$ 958	\$ 1110	\$ 1283
66"	TB-6666W	2.00	\$ 383	\$ 564	\$ 646	\$ 737	\$ 856	\$ 984	\$ 1136	\$ 1309
72"	TB-6672W	2.25	\$ 405	\$ 609	\$ 702	\$ 804	\$ 938	\$ 1081	\$ 1253	\$ 1447
78"	TB-6678W	2.50	\$ 439	\$ 666	\$ 769	\$ 882	\$ 1031	\$ 1191	\$ 1381	\$ 1597
84"	TB-6684W	2.50	\$ 449	\$ 675	\$ 778	\$ 891	\$ 1040	\$ 1200	\$ 1390	\$ 1606
90"	TB-6690W	2.75	\$ 474	\$ 723	\$ 837	\$ 961	\$ 1125	\$ 1301	\$ 1510	\$ 1748
96"	TB-6696W	3.00	\$ 496	\$ 768	\$ 891	\$ 1027	\$ 1206	\$ 1397	\$ 1626	\$ 1885
102"	TB-66102W	3.25	\$ 508	\$ 803	\$ 936	\$ 1084	\$ 1278	\$ 1485	\$ 1732	\$ 2013
108"	TB-66108W	3.50	\$ 532	\$ 849	\$ 993	\$ 1151	\$ 1360	\$ 1584	\$ 1850	\$ 2153

NOTE: All tackboards 78" and longer are 2 pieces.

TASKLIGHTS - Includes 3 Wire Management Grommets

Model #	Size	Description	List Price
TL-0824	22 1/2" x 1 5/8" x 7/8"	84-LED, 7 Watts	\$ 234
TL-0848	47 1/2" x 1 5/8" x 7/8"	240-LED, 18 Watts	\$ 280
01-47LED17	16 13/32" x 2" x 1/2"	47-LED, 10.9 Watts	\$ 436
01-94LED31	30 1/8" x 2" x 1/2"	94-LED, 23.4 Watts	\$ 755
01-188LED58	57 13/32" x 2" x 1/2"	188-LED, 43.5 Watts	\$ 1043
01-OSRP	2 5/16" x 2" x 1/2"	Occupancy Sensor	\$ 232

- All LED Lights Include the Power Supply
- Optional Occupancy Sensor Shuts Off After 30 Minutes of Inactivity and Turns on Immediately When Reentering the Detection Area. Does Not Apply to TL Models.

TALL TACKBOARDS - for Wall Mount Hutches Over Low Height Credenzas or Benches - 35" TALL

Size	Model #	COM ydg	COM, Grade 1, 2 or 3 List Price	Grade 4 List Price	Grade 5 List Price	Grade 6 List Price	Grade 7 List Price	Grade 8 List Price	Grade 9 List Price	Grade 10 List Price
30"	TB-6630TW	1.00	\$ 324	\$ 415	\$ 456	\$ 501	\$ 561	\$ 625	\$ 701	\$ 787
36"	TB-6636TW	1.25	\$ 360	\$ 473	\$ 525	\$ 581	\$ 656	\$ 736	\$ 831	\$ 939
42"	TB-6642TW	1.25	\$ 369	\$ 483	\$ 534	\$ 591	\$ 665	\$ 745	\$ 840	\$ 948
48"	TB-6648TW	1.50	\$ 410	\$ 545	\$ 607	\$ 675	\$ 765	\$ 860	\$ 974	\$ 1104
54"	TB-6654TW	1.75	\$ 451	\$ 609	\$ 681	\$ 760	\$ 865	\$ 977	\$ 1110	\$ 1261
60"	TB-6660TW	2.00	\$ 474	\$ 655	\$ 738	\$ 828	\$ 948	\$ 1075	\$ 1228	\$ 1400
66"	TB-6666TW	2.00	\$ 506	\$ 687	\$ 770	\$ 860	\$ 980	\$ 1107	\$ 1259	\$ 1432
72"	TB-6672TW	2.25	\$ 527	\$ 731	\$ 823	\$ 925	\$ 1059	\$ 1203	\$ 1374	\$ 1569
78"	TB-6678TW	2.50	\$ 571	\$ 797	\$ 900	\$ 1014	\$ 1163	\$ 1322	\$ 1513	\$ 1729
84"	TB-6684TW	2.50	\$ 583	\$ 810	\$ 913	\$ 1026	\$ 1175	\$ 1335	\$ 1525	\$ 1741
90"	TB-6690TW	2.75	\$ 615	\$ 864	\$ 978	\$ 1102	\$ 1266	\$ 1442	\$ 1651	\$ 1889
96"	TB-6696TW	3.00	\$ 644	\$ 916	\$ 1039	\$ 1175	\$ 1354	\$ 1546	\$ 1774	\$ 2033
102"	TB-66102TW	3.25	\$ 664	\$ 958	\$ 1092	\$ 1239	\$ 1433	\$ 1640	\$ 1888	\$ 2169
108"	TB-66108TW	3.50	\$ 693	\$ 1009	\$ 1154	\$ 1312	\$ 1521	\$ 1744	\$ 2011	\$ 2313

CUSHIONS

Model #	COM ydg	COM, Grade 1, 2 or 3 List Price	Grade 4 List Price	Grade 5 List Price	Grade 6 List Price	Grade 7 List Price	Grade 8 List Price	Grade 9 List Price	Grade 10 List Price	Grade L1 List Price	Grade L2 List Price
66-1519CUSHION	0.75	\$ 210	\$ 278	\$ 309	\$ 343	\$ 387	\$ 435	\$ 492	\$ 557	\$ 374	\$ 445
66-2430CUSHION	1.25	\$ 242	\$ 332	\$ 374	\$ 419	\$ 478	\$ 542	\$ 618	\$ 705	\$ 460	\$ 556
66-2436CUSHION	1.25	\$ 280	\$ 393	\$ 445	\$ 501	\$ 576	\$ 655	\$ 751	\$ 859	\$ 553	\$ 672
66-2460CUSHION	2.00	\$ 329	\$ 510	\$ 593	\$ 683	\$ 803	\$ 930	\$ 1083	\$ 1255	\$ 766	\$ 957
66-2472CUSHION	2.25	\$ 379	\$ 582	\$ 675	\$ 777	\$ 911	\$ 1055	\$ 1226	\$ 1421	\$ 870	\$ 1085
66-2490CUSHION	2.75	\$ 451	\$ 700	\$ 813	\$ 937	\$ 1102	\$ 1277	\$ 1486	\$ 1724	\$ 1051	\$ 1314
66-24108CUSHION	3.25	\$ 498	\$ 792	\$ 926	\$ 1073	\$ 1267	\$ 1475	\$ 1722	\$ 2003	\$ 1207	\$ 1518

ElevateTM

Casegoods Collection

How to Order

MODEL NO.	DESCRIPTION	
40-3672DP	Finish	EW
	Top Surface	W
	Accent	SLV
	Pull	ABR

All options must be labeled and specified.



Specifications



VENEER

Exposed surfaces feature select grade sliced hardwood veneers in Cherry, Maple, or American Black Walnut. Veneers are carefully selected and matched to assure proper balance and consistency.

TOPS

Tops are 3-ply balanced construction and 1" thick combined with a ½" thick sub-top to create the Elevate edge detail. Grain direction runs left to right unless otherwise noted.

CHASSIS CONSTRUCTION

Tops and end panels are securely fastened using high quality fastening systems to assure maximum strength. All units are equipped with heavy-duty, adjustable glides to ensure proper leveling and compensation for uneven floors. All units have finished backs unless noted. All desks, non-lateral credenzas, and returns have wire management access from pedestal to kneespace.

DRAWERS

All drawer fronts are standard with elegant veneer faces. Fronts are 3-ply construction ¾" thick and vertically matched in sets. Drawer interiors are constructed with wood grain vinyl wrapped sides, ½" thick. Box and file drawers have ⅛" thick hardboard bottoms. Lateral file drawers feature ¼" thick bottoms. 5-sided drawer construction allows for easy removal of drawer fronts.

DRAWER SUSPENSIONS

All drawers feature full extension, progressive action slides with precision steel ball bearings. Box and file drawers are tested for 100 lb capacity. Lateral files are tested for 150 lb capacity. Self-closing suspension tracks are optional on box and file drawers. All suspensions have a limited life-time warranty.

FILING HARDWARE

All file drawers are standard with filing systems designed to accommodate a variety of filing requirements. Fully constructed units have letter width file drawers which provide letter filing front to back and letter or legal filing side to side. Component pedestals provide letter filing front to back and legal filing side to side. Lateral file drawers provide legal or letter filing front to back or side to side.

LOCKING

All desks, credenzas, and lateral files feature locking in black or silver to match the pulls. Removable lock cylinders allow for units to be re-keyed at a later date if required. Units are shipped randomly keyed as standard. Lock cores match pull color.

CORD MANAGEMENT

Route power and data cables away from the worksurface through inherent grommet placement. Grommets may be ordered in the tops of all assembled desks, returns, bridges, credenzas, and component worksurfaces. All desks, returns, and credenzas (except lateral pedestals) have standard wire openings from inside the pedestal to the kneespace allowing quick access to technology below. Additionally, returns, bridge units, kneespace credenzas, and hutch units have standard grommets available in backpanels. Grommets are also standard in the tops of corner units and extended corner units. See page 102 for all optional grommet locations.

Undersurface tracks are available for additional cord management. Silver grommets are also available. See Accessories.

FINISH

Elevate features Ultra-Violet matte finish on all exposed surfaces by utilizing roll-coat UV technology. Our durable UVAdvantage® finish makes surfaces less likely to be damaged by abrasions, scratches, water, alcohol, stains, and common chemicals. Our UVAdvantage® finish magnifies the beauty of our wood finishes and reduces the darkening, aging, and yellowing process of wood furniture that naturally occurs over time. Once cured by UV lighting, our UVAdvantage® finish does not emit irritable toxins, formaldehyde, or solvents into the air creating a safe work environment within new furniture installations. This process has allowed us to achieve third party certification for Indoor Air Quality. Additionally our UVAdvantage® finish greatly reduces hazardous air pollutants which contribute to smog formation, and our UVAdvantage® finish is recaptured over and over again reducing waste materials. Automated production technology eliminates exposure to sprayed chemicals in our factories. High gloss UVAdvantage® finish available on request.

Shape Your Environment

Finish Options

WOOD VENEER (W) OR LAMINATE (P) TOPS – MUST SPECIFY



Clear Maple
CM



Light Maple
LM



Golden Cherry
GC



Legacy Walnut
LW



Autumn Cherry
AC



Columbian Walnut
CO



Artisan Walnut
AW



Harvest Walnut
HW



Bourbon Cherry
BC



Dark Cherry
DC



Mahogany on Walnut
MW



Espresso Walnut
EW

Available in High Pressure Laminate Tops. (P)

Accent Color



Aluminum



Black

All Elevate tops are standard with the elevated profile. The color for tops, locks and mouldings will be determined by the pull option color.

Pull Options



Aluminum Bar
ABR



Aluminum Beam
ABM



Aluminum Ramp
ARM



Black Bar
BBR



Black Beam
BBM



Black Ramp
BRM

INTERIOR DRAWER DIMENSIONS

ELEVATE 4000 INTERIOR DRAWER DIMENSIONS

Item	Drawers	W	L	D
40-4272RPTD/LPTD	Box	12 1/8	16 3/16	9 1/4
40-3672RPS/LPS	File	12 1/8	19 3/16	3 1/2
40-3672RP/LP				
40-3672DPS				
40-3672DP				
40-3072RP/LP				
40-3072DP				
40-3066RP/LP				
40-3066DP				
40-3060DP				
40-2418PD1	Box	14 9/32	15 1/8	3 1/2
40-1872WBL/WBR	File	14 9/32	15 1/8	9 1/4
40-1872MWBL/MWBR				
40-1872AWBL/AWBR				
40-2472LC1/RC1	Box	12 1/8	16 3/16	9 1/4
40-2466LC1/RC1	File	12 1/8	16 3/16	3 1/2
40-2448LF1/RF1				
40-2442LF1/RF1				
40-1622MP				
40-2472LMR/RMR	Box	14 9/32	15 1/8	3 1/2
40-2472LMF/RMF	File	14 9/32	15 1/8	9 1/4
40-2466LMF/RMF	Lat File	31 9/16	15 1/8	9 1/4
40-1622CD	Center	19	15	1 1/8
40-2472SC	File	12 1/8	16 3/16	9 1/4
40-2472LC2/RC2				
40-2472KC				
40-2466SC				
40-2466LC2/RC2				
40-2466KC				
40-2448LF2/RF2				
40-2442LF2/RF2				
40-2418PD2	File	14 9/32	15 1/8	9 1/4
40-1872WFL/WFR				
40-1872MWFL/MWFR				
40-1872AWFL/AWFR				
40-2472LL/RL	Lat File	31 1/2	15 1/8	9 1/4
40-2472DL				
40-2466LL/RL				
40-2436L4				
40-2436L2				
40-2436LF1	Lat File	32 9/32	15 1/8	9 1/4
40-2430LF1	Lat File	26 9/32	15 1/8	9 1/4

FILING CAPABILITIES

12 1/8 x 16 3/16

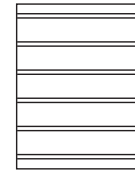

Letter Front to Back

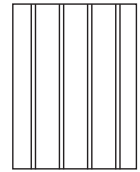

Legal Side to Side

12 1/8 x 19 3/16

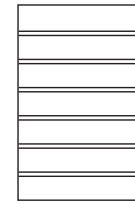

Letter Front to Back

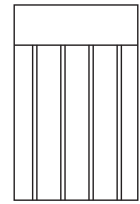

Legal Side to Side

14 9/32 x 15 1/8

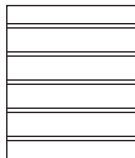

Legal Front to Back

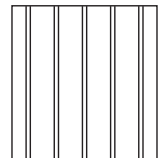

Legal Side to Side

26 9/32 x 15 1/8

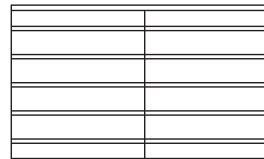

2 Rows Letter Front to Back



1 Row Letter or Legal Side to Side

31 1/2 x 15 1/8

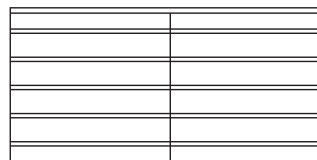

2 Rows Letter or Legal Front to Back

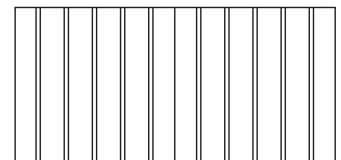

1 Row Letter or Legal Side to Side

32 9/32 x 15 1/8

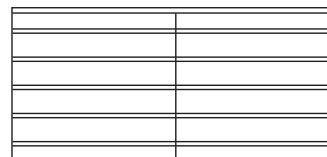

2 Rows Letter or Legal Front to Back

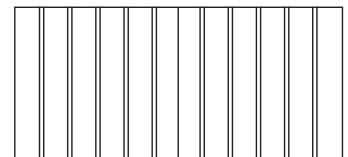

1 Row Letter or Legal Side to Side

GROMMET LOCATIONS

Grommets are standard in the back panels of returns, bridges, and credenzas. These units may be ordered without grommets at no additional charge. Please specify "NO GROMMET" on order.

Grommets are available on hutches in standard locations for tasklight management at no additional charge. Please specify HUGRMT.

Desk grommets are available in standard locations. Please specify and add an upcharge of \$48 list for each grommet.

Specify grommet locations.

- GL - Grommet Left
- GC - Grommet Center
- GR - Grommet Right

Example: 40-3672DP-GL-GR (Grommet Left, Grommet Right)

Grommets may be ordered in non-standard locations. Please call Customer Service to assist with how to order and additional lead time requirements.

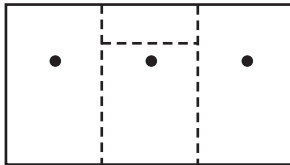

40-3672DPS
40-3672RPS/LPS

GL/GR - 6" from ends, 22 1/2" from user side.
GC - 22 1/2" from user side.

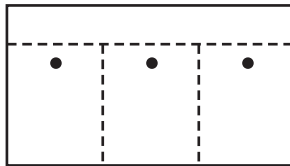

40-3672DP 40-3672RP/LP
40-3072DP 40-3072RP/LP
40-3066DP 40-3066RP/LP
40-3060DP

GL/GR - 6" from ends, 22 1/2" from user side.
GC - 22 1/2" from user side.

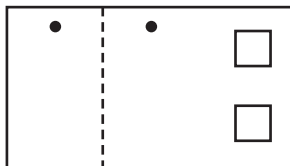

40-4272RPTD - GR and GC Available
40-4272LPTD - GL and GC Available

GL/GR - 6" from ends, 32 1/2" from user side.
GC - 32 1/2" from user side.

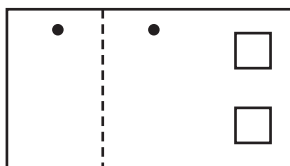

40-3672RPTD - GR and GC Available
40-3672LPTD - GL and GC Available

GL/GR - 6" from ends, 26 1/2" from user side.
GC - 26 1/2" from user side.

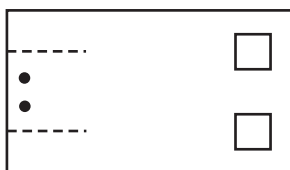

40-4272RRP - GSL Available
40-4272LRP - GSR Available

GSL/GSR - 6" from ends, 18" from user side.

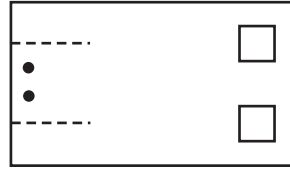
GROMMET LOCATIONS - CONTINUED

40-3672RRP - GSL Available
40-3672LRP - GSR Available

GSL/GSR - 6" from ends, 12" from user side.

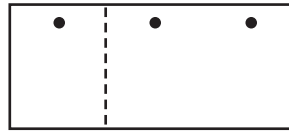

40-2448LF1/RF1 40-2442LF2/RF2
40-2448LF2/RF2 40-2448UF/UFH
40-2442CW 40-2442UF/UFH
40-2442LF1/RF1

All Return Component Tops -
Page 135.

GL/GR - 6" from ends, 20" from user side.
GC - 20" from user side.

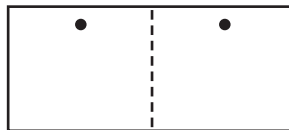

40-2472RMR/LMR 40-2472LL/RL
40-2472LMF/RMF 40-2466LL/RL
40-2466LMF/RMF

GL/GR - 6" from ends, 20" from user side.
Grommets are only available opposite the pedestal.

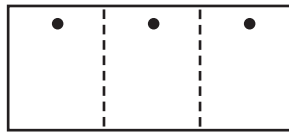

40-2472RC1/LC1 40-2472KC
40-2472RC2/LC2 40-2466KC
40-2466RC1/LC1
40-2466RC2/LC2

All Credenza Component Tops -
Page 134.

GL/GR - 6" from ends, 20" from user side.
GC - 20" from user side.

LOCKING HUTCH DOORS

Locking doors are available on all hutches and surface mounted towers. Please specify locking and add the upcharge according to the size of the unit.

Size		List Upcharge
18"	=	\$43.00
30" - 42"	=	\$58.00
48" - 78"	=	\$71.00
84" - 108"	=	\$84.00

Locking doors are available on wardrobes as noted on pages 125-130. Please specify locking and add \$43.00 list upcharge.

SOFT-CLOSING DRAWERS

Soft-closing drawers are available on units with box and file drawers. All drawers within a unit must be specified as soft-closing. Lateral file drawers are not available with soft-closing hardware.

Please call for prices.

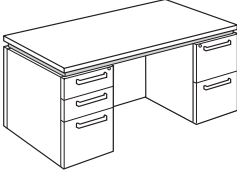
Item	Model No.	W	D	H	K	R	Ship Wt	Cubic Ft	List Price
	40-3672DPS Stepped Front	72	36	30	40 ⁵ / ₁₆	-	319	51.8	P \$ 4357 W \$ 4464
	40-3672DP Recessed Front	72	36	30	39 ⁹ / ₁₆	-	319	51.8	P \$ 3893 W \$ 4001
	40-3072DP Recessed Front	72	30	30	39 ⁹ / ₁₆	-	287	42.8	P \$ 3749 W \$ 3836
	40-3066DP Recessed Front	66	30	30	33 ⁹ / ₁₆	-	258	39.4	P \$ 3571 W \$ 3718
	40-3060DP Recessed Front	60	30	30	27 ⁹ / ₁₆	-	233	35.9	P \$ 3494 W \$ 3563

Description

- Modesty Standard with Molding Accent
- Box/Box/File in Left Pedestal; File/File in Right Pedestal
- Wire Management from Pedestal to Kneespace
- Letter Width Pedestal
- Locking

Options: Specify & Add (ONLY Available on 40-3672DPS)

40-SAM	Optional Aluminum Framed Frosted Acrylic Modesty Panel	\$ 456
40-WAM	Optional Wood Framed Frosted Acrylic Modesty Panel	\$ 338

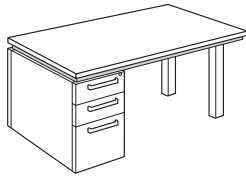
FREESTANDING TABLE DESK WITH PEDESTAL

Left Ped	Right Ped	W	D	H	K	R	Ship Wt	Cubic Ft	List Price
40-4272LPTD	40-4272RPTD	72	42	30	-	-	278	58.9	P \$ 3457 W \$ 3671
40-3672LPTD	40-3672RPTD	72	36	30	-	-	238	50.9	P \$ 3269 W \$ 3375

Description

- Freestanding
- Square Wooden Legs
- Box/Box/File in Pedestal
- Wire Management from Pedestal to Kneespace
- File Drawer Allows Legal or Letter Filing
- Letter Width Pedestal
- Locking

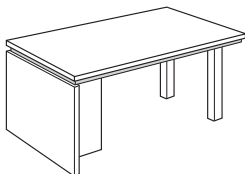
PENINSULA DESK

Shown as a Right Ped

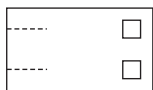

Left Ped	Right Ped	W	D	H	K	R	Ship Wt	Cubic Ft	List Price
40-4272LRP	40-4272RRP	72	42	30	-	-	207	58.9	P \$ 2318 W \$ 2532
40-3672LRP	40-3672RRP	72	36	30	-	-	177	50.9	P \$ 2172 W \$ 2279

Description

- Square Wooden Legs
- End Panel Support
- Includes Stifner Bar

Options: Specify & Add

40-FMD	Optional Full Veneer Modesty Panel	\$ 357
--------	------------------------------------	--------

All pedestal desks shown as left.

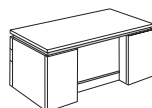

Stepped Front

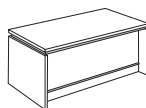

Recessed Front

For ordering options, see back of Elevate Identification card at the beginning of section.

For grommet options, see page 102.

For center drawer options, see page 132.

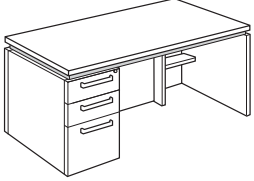
Item	Model No.	W	D	H	K	R	Ship Wt	Cubic Ft	List Price	
EXECUTIVE SINGLE PED DESK 	Left Ped	Right Ped								
	40-3672LPS Stepped Front	40-3672RPS	72	36	30	30 9/16	-	290	50.9	P \$ 3682 W \$ 3789
	40-3672LP Recessed Front	40-3672RP	72	36	30	30 9/16	10 1/8	290	51.8	P \$ 3228 W \$ 3335
	40-3072LP Recessed Front	40-3072RP	72	30	30	30 9/16	4 1/8	242	42.8	P \$ 3090 W \$ 3177
	40-3066LP Recessed Front	40-3066RP	66	30	30	24 9/16	4 1/8	222	39.4	P \$ 2859 W \$ 3006

Description

- Modesty Standard with Molding Accent
- Box/Box/File in Pedestal
- Wire Management from Pedestal to Kneespace
- File Drawer Allows Legal or Letter Filing
- Letter Width Pedestal
- Locking

Options: Specify & Add (ONLY Available on 40-3672LPS or RPS)

40-SAM	Optional Aluminum Framed Frosted Acrylic Modesty Panel	\$ 456
40-WAM	Optional Wood Framed Frosted Acrylic Modesty Panel	\$ 338

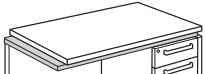
EXECUTIVE RETURN BOX/BOX/FILE 	Left Ped	Right Ped								
	40-2448LF1	40-2448RF1	48	24	30	31 3/4	-	149	23.5	P \$ 2053 W \$ 2108
	40-2442LF1	40-2442RF1	42	24	30	25 3/4	-	130	20.7	P \$ 1996 W \$ 2046

Description

- Box/Box/File in Pedestal
- Wire Management from Pedestal to Kneespace
- File Drawer Allows Legal or Letter Filing
- Letter Width Pedestal
- Locking
- Grommet in Back Panel
- Grain Direction Runs Front to Back on Veneer Worksurface

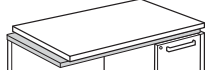
EXECUTIVE RETURN FILE/FILE 	Left Ped	Right Ped								
	40-2448LF2	40-2448RF2	48	24	30	31 3/4	-	149	23.5	P \$ 2053 W \$ 2108
	40-2442LF2	40-2442RF2	42	24	30	25 3/4	-	130	20.7	P \$ 1996 W \$ 2046

Description

- File/File in Pedestal
- Wire Management from Pedestal to Kneespace
- File Drawer Allows Legal or Letter Filing
- Letter Width Pedestal
- Locking
- Grommet in Back Panel
- Grain Direction Runs Front to Back on Veneer Worksurface

All pedestal desks shown as left.
 All returns shown as right.

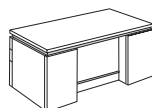

Stepped Front

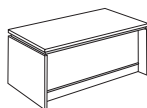

Recessed Front

For ordering options, see back of Elevate Identification card at the beginning of section.

For grommet options, see page 102.

For center drawer options, see page 132.

Item	Model No.	W	D	H	K	R	Ship Wt	Cubic Ft	List Price	
EXECUTIVE RETURN MULTI-FILE PEDESTAL BOX/BOX/FILE/LATERAL	Left Ped									
	Right Ped									
	40-2472LMR	40-2472RMR	72	24	30	35 31/32	-	272	35.5	P \$ 3320 W \$ 3410

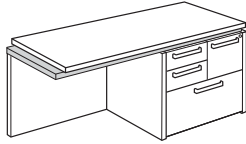
Description

- Box/Box/File/Lateral in Pedestal
- Legal Width File Drawer
- Locking File Drawers Only
- File Drawers Provide Legal or Letter Filing
- Grain Direction Runs Front to Back on Veneer Worksurfaces
- Grommet in Back Panel

CORNER UNIT	40-4242CU	42	42	30	25 7/16	-	145	35.0	P \$ 2030 W \$ 2203
	40-3636CU	36	36	30	17	-	135	26.1	P \$ 1800 W \$ 1977

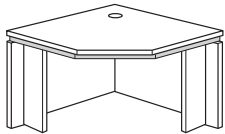
Description

- Connects to 24" Deep Bridge and Return Units
- Grommet in Top
- Grain Direction Runs Front to Back on Worksurface

NOTE: Not all keyboards will fit the 40-3636CU. Recommended keyboards are 1-KCWR, 1-KCPR, and 1-KC.

All returns shown as right.

For ordering options, see back of Elevate Identification card at the beginning of section.

For grommet options, see page 102.

Item	Model No.	W	D	H	K	R	Ship Wt	Cubic Ft	List Price
EXECUTIVE BRIDGE FULL MODESTY	40-2448UF	48	24	30	-	-	78	4.5	P \$ 1077 W \$ 1134
	40-2442UF	42	24	30	-	-	71	4.0	P \$ 1009 W \$ 1058

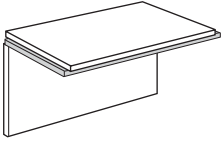
Description

- Grommet in Back Panel
- Grain Direction Runs Front to Back on Veneer Worksurface
- Hinged Back Panel

NOTE: Keyboards can not be factory installed.

EXECUTIVE BRIDGE HALF MODESTY	40-2448UFH	48	24	30	-	-	68	4.5	P \$ 855 W \$ 911
	40-2442UFH	42	24	30	-	-	61	4.0	P \$ 820 W \$ 870

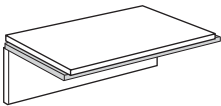

Description

- Grain Direction Runs Front to Back on Veneer Worksurface
- Hinged Back Panel

NOTE: Keyboards can not be factory installed.

For ordering options, see back of Elevate Identification card at the beginning of section.

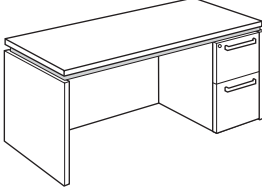
For grommet options, see page 102.

Item	Model No.	W	D	H	K	R	Ship Wt	Cubic Ft	List Price	
EXECUTIVE CREDENZA FILE/FILE 	Left Ped	Right Ped								
	40-2472LC2	40-2472RC2	72	24	30	30 5/8	-	235	34.8	P \$ 2693 W \$ 2784
	40-2466LC2	40-2466RC2	66	24	30	24 5/8	-	215	32.0	P \$ 2637 W \$ 2725

Description

- File/File in Pedestal
- Wire Management from Pedestal to Kneespace
- File Drawers Provide Legal or Letter Filing
- Letter Width Pedestal
- Locking
- Grommet in Back Panel

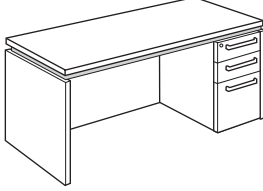
Item	Model No.	W	D	H	K	R	Ship Wt	Cubic Ft	List Price	
EXECUTIVE CREDENZA BOX/BOX/FILE 	Left Ped	Right Ped								
	40-2472LC1	40-2472RC1	72	24	30	30 5/8	-	235	34.8	P \$ 2693 W \$ 2784
	40-2466LC1	40-2466RC1	66	24	30	24 5/8	-	215	32.0	P \$ 2637 W \$ 2725

Description

- Box/Box/File in Pedestal
- Wire Management from Pedestal to Kneespace
- File Drawer Provides Legal or Letter Filing
- Letter Width Pedestal
- Locking
- Grommet in Back Panel

All credenzas shown as right.

For ordering options, see back of Elevate Identification card at the beginning of section.

For grommet options, see page 102.

Item	Model No.	W	D	H	K	R	Ship Wt	Cubic Ft	List Price	
EXECUTIVE CREDENZA LATERAL/LATERAL	Left Ped	Right Ped								
	40-2472LL	40-2472RL	72	24	30	10 ¹³ / ₁₆	-	280	34.8	P \$ 3164 W \$ 3257
	40-2466LL	40-2466RL	66	24	30	4 ¹³ / ₁₆	-	252	32.0	P \$ 3102 W \$ 3190

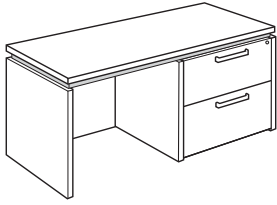
Description

- Two Lateral Files
- Provides Legal or Letter Filing
- Locking
- Grommet in Back Panel

Item	Model No.	W	D	H	K	R	Ship Wt	Cubic Ft	List Price	
EXECUTIVE CREDENZA MULTI-FILE PEDESTAL BOX/BOX/FILE/LATERAL	Left Ped	Right Ped								
	40-2472LMF	40-2472RMF	72	24	30	10 ¹³ / ₁₆	-	290	35.5	P \$ 3572 W \$ 3664
	40-2466LMF	40-2466RMF	66	24	30	4 ¹³ / ₁₆	-	261	32.7	P \$ 3508 W \$ 3595

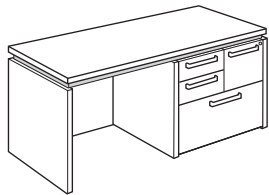
Description

- Box/Box/File/Lateral in Pedestal
- File Drawers Provide Legal or Letter Filing
- Locking File Drawers Only
- Grommet in Back Panel

All credenzas shown as right.

For ordering options, see back of Elevate Identification card at the beginning of section.

For grommet options, see page 102.

Item	Model No.	W	D	H	K	R	Ship Wt	Cubic Ft	List Price
STORAGE CREDENZA FULL PEDESTAL	40-2472SC	72	24	30	-	-	273	35.6	P \$ 3940 W \$ 4034
	40-2466SC	66	24	30	-	-	246	32.0	P \$ 3827 W \$ 3914

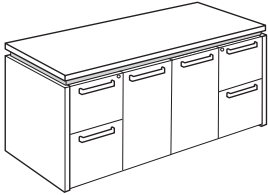
Description

- File/File in Both Pedestals
- File Drawers Provide Legal or Letter Filing
- Locking Pedestals
- Letter Width Pedestals
- 12" Fixed Shelf in Storage Behind Doors

KNEESPACE CREDENZA FULL PEDESTAL	40-2472KC	72	24	30	39 ⁹ / ₁₆	-	256	35.6	P \$ 3381 W \$ 3473
	40-2466KC	66	24	30	33 ⁹ / ₁₆	-	230	32.0	P \$ 3299 W \$ 3386

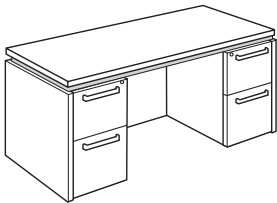

Description

- File/File in Both Pedestals
- Wire Management from Pedestal to Kneespace
- File Drawers Provide Legal or Letter Filing
- Locking Pedestals
- Letter Width Pedestals
- Grommet in Back Panel

For ordering options, see back of Elevate Identification card at the beginning of section.

For grommet options, see page 102.

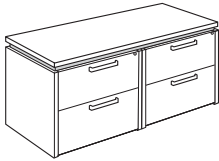
Item	Model No.	W	D	H	K	R	Ship Wt	Cubic Ft	List Price
DOUBLE LATERAL CREDENZA	40-2472DL	72	24	30	-	-	370	34.8	P \$ 4281 W \$ 4373

Description

- Dual Locking
- File Drawers Provide Legal or Letter Filing
- 1/4" Thick Drawer Bottoms Allow for Storage Applications

FOUR DRAWER LATERAL FILE	40-2436L4	36	24	57 5/16	-	-	260	33.2	P \$ 3707 W \$ 3756
--------------------------	-----------	----	----	---------	---	---	-----	------	------------------------

Description

- Locking Drawers
- Anti-Tilt System
- File Drawers Provide Legal or Letter Filing Front to Back or Side to Side
- 1/4" Thick Drawer Bottoms Allow for Storage Applications

TWO DRAWER LATERAL FILE	40-2436L2	36	24	30	-	-	185	17.9	P \$ 2244 W \$ 2294
-------------------------	-----------	----	----	----	---	---	-----	------	------------------------

Description

- Locking Drawers
- Anti-Tilt System
- File Drawers Provide Legal or Letter Filing Front to Back or Side to Side
- 1/4" Thick Drawer Bottoms Allow for Storage Applications

MOBILE PEDESTAL	40-1622MP	16	22	23 3/8	-	-	73	5.0	\$ 1571
-----------------	-----------	----	----	--------	---	---	----	-----	---------

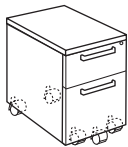
Description

- Box/File in Pedestal
- File Drawers Provide Legal or Letter Filing Front to Back or Side to Side
- Letter Width Pedestal
- Locking Drawers
- Casters Allow for Easy Moving
- Fits Underneath 30" H Worksurface

For ordering options, see back of Elevate Identification card at the beginning of section.

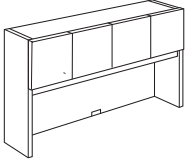
Item	Model No.	W	D	H	K	R	Ship Wt	Cubic Ft	List Price
VENEER DOOR SURFACE MOUNT HUTCHES 	40-15108HU Six Doors	108	15	40 ¹³ / ₁₆	-	-	206	50.4	\$ 4736
	40-15102HU Six Doors	102	15	40 ¹³ / ₁₆	-	-	195	47.7	\$ 4651
	40-1596HU Six Doors	96	15	40 ¹³ / ₁₆	-	-	184	44.9	\$ 4554
	40-1590HU Five Doors	90	15	40 ¹³ / ₁₆	-	-	172	42.2	\$ 4146
	40-1584HU Five Doors	84	15	40 ¹³ / ₁₆	-	-	160	39.4	\$ 3860
	40-1578HU Four Doors	78	15	40 ¹³ / ₁₆	-	-	148	36.7	\$ 3440
	40-1572HU Four Doors	72	15	40 ¹³ / ₁₆	-	-	201	34.1	\$ 3127
	40-1566HU Four Doors	66	15	40 ¹³ / ₁₆	-	-	184	32.1	\$ 2980
	40-1560HU Four Doors	60	15	40 ¹³ / ₁₆	-	-	167	28.4	\$ 2852
	40-1554HU Three Doors	54	15	40 ¹³ / ₁₆	-	-	150	25.7	\$ 2592
	40-1548HU Three Doors	48	15	40 ¹³ / ₁₆	-	-	133	22.9	\$ 2389
	40-1542HU Two Doors	42	15	40 ¹³ / ₁₆	-	-	116	20.2	\$ 2110
	40-1536HU Two Doors	36	15	40 ¹³ / ₁₆	-	-	99	17.4	\$ 1963

Description

- Storage Behind Wood Doors
- Grommet
- 23 ³/₄" Clearance Below Doors

For ordering options, see back of Elevate Identification card at the beginning of section.

For tackboard and tasklights, see page 142.

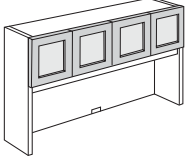
Item	Model No.	W	D	H	K	R	Ship Wt	Cubic Ft	List Price
METALLIC FROSTED ACRYLIC DOOR SURFACE MOUNT HUTCHES 	40-15108HM Six Doors	108	15	40 ¹³ / ₁₆	-	-	206	50.4	\$ 5200
	40-15102HM Six Doors	102	15	40 ¹³ / ₁₆	-	-	195	47.7	\$ 5029
	40-1596HM Six Doors	96	15	40 ¹³ / ₁₆	-	-	184	44.9	\$ 4887
	40-1590HM Five Doors	90	15	40 ¹³ / ₁₆	-	-	172	42.2	\$ 4527
	40-1584HM Five Doors	84	15	40 ¹³ / ₁₆	-	-	160	39.4	\$ 4297
	40-1578HM Four Doors	78	15	40 ¹³ / ₁₆	-	-	148	36.7	\$ 3703
	40-1572HM Four Doors	72	15	40 ¹³ / ₁₆	-	-	201	34.1	\$ 3420
	40-1566HM Four Doors	66	15	40 ¹³ / ₁₆	-	-	184	32.1	\$ 3248
	40-1560HM Four Doors	60	15	40 ¹³ / ₁₆	-	-	167	28.4	\$ 3022
	40-1554HM Three Doors	54	15	40 ¹³ / ₁₆	-	-	150	25.7	\$ 2775
	40-1548HM Three Doors	48	15	40 ¹³ / ₁₆	-	-	133	22.9	\$ 2543
	40-1542HM Two Doors	42	15	40 ¹³ / ₁₆	-	-	116	20.2	\$ 2210
	40-1536HM Two Doors	36	15	40 ¹³ / ₁₆	-	-	99	17.4	\$ 2074

Description

- Storage Behind Metallic Framed Frosted Acrylic Doors
- Grommet
- 23 ³/₄" Clearance Below Doors

For ordering options, see back of Elevate Identification card at the beginning of section.

For tackboard and tasklights, see page 142.

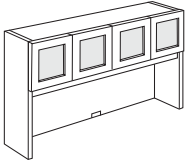
Item	Model No.	W	D	H	K	R	Ship Wt	Cubic Ft	List Price
WOOD FROSTED ACRYLIC DOOR SURFACE MOUNT HUTCHES 	40-15108AH Six Doors	108	15	40 ¹³ / ₁₆	-	-	206	50.4	\$ 5529
	40-15102AH Six Doors	102	15	40 ¹³ / ₁₆	-	-	195	47.7	\$ 5382
	40-1596AH Six Doors	96	15	40 ¹³ / ₁₆	-	-	184	44.9	\$ 5202
	40-1590AH Five Doors	90	15	40 ¹³ / ₁₆	-	-	172	42.2	\$ 4643
	40-1584AH Five Doors	84	15	40 ¹³ / ₁₆	-	-	160	39.4	\$ 4461
	40-1578AH Four Doors	78	15	40 ¹³ / ₁₆	-	-	148	36.7	\$ 4057
	40-1572AH Four Doors	72	15	40 ¹³ / ₁₆	-	-	201	34.1	\$ 3557
	40-1566AH Four Doors	66	15	40 ¹³ / ₁₆	-	-	184	32.1	\$ 3430
	40-1560AH Four Doors	60	15	40 ¹³ / ₁₆	-	-	167	28.4	\$ 3241
	40-1554AH Three Doors	54	15	40 ¹³ / ₁₆	-	-	150	25.7	\$ 2900
	40-1548AH Three Doors	48	15	40 ¹³ / ₁₆	-	-	133	22.9	\$ 2722
	40-1542AH Two Doors	42	15	40 ¹³ / ₁₆	-	-	116	20.2	\$ 2374
	40-1536AH Two Doors	36	15	40 ¹³ / ₁₆	-	-	99	17.4	\$ 2138

Description

- Storage Behind Wood Framed Frosted Acrylic Doors
- Grommet
- 23 ³/₄" Clearance Below Doors

For ordering options, see back of Elevate Identification card at the beginning of section.

For tackboard and tasklights, see page 142.

Item	Model No.	W	D	H	K	R	Ship Wt	Cubic Ft	List Price
VENEER DOOR WALL MOUNT HUTCHES 	40-15108WD Six Doors	108	15	17 1/16	-	-	155	41.3	\$ 4206
	40-15102WD Six Doors	102	15	17 1/16	-	-	146	39.0	\$ 4099
	40-1596WD Six Doors	96	15	17 1/16	-	-	138	36.8	\$ 3974
	40-1590WD Five Doors	90	15	17 1/16	-	-	150	34.5	\$ 3626
	40-1584WD Five Doors	84	15	17 1/16	-	-	140	32.3	\$ 3465
	40-1578WD Four Doors	78	15	17 1/16	-	-	130	15.0	\$ 3114
	40-1572WD Four Doors	72	15	17 1/16	-	-	120	13.9	\$ 2758
	40-1566WD Four Doors	66	15	17 1/16	-	-	110	12.8	\$ 2658
	40-1560WD Four Doors	60	15	17 1/16	-	-	100	11.6	\$ 2520
	40-1554WD Three Doors	54	15	17 1/16	-	-	90	10.5	\$ 2264
	40-1548WD Three Doors	48	15	17 1/16	-	-	80	9.4	\$ 2100
	40-1542WD Two Doors	42	15	17 1/16	-	-	70	8.3	\$ 1788
	40-1536WD Two Doors	36	15	17 1/16	-	-	60	7.2	\$ 1661

Description

- Mounts to Wall with Mounting Brackets Included
- Storage Behind Wood Grained Doors
- Unfinished Back

NOTE: Indiana Furniture will not be liable for wall mount hutch units that are not properly installed.

For ordering options, see back of Elevate Identification card at the beginning of section.

For tackboard and tasklights, see page 142.

Item	Model No.	W	D	H	K	R	Ship Wt	Cubic Ft	List Price
METALLIC FROSTED ACRYLIC DOOR WALL MOUNT HUTCHES 	40-15108WM Six Doors	108	15	17 1/16	-	-	155	41.3	\$ 4633
	40-15102WM Six Doors	102	15	17 1/16	-	-	146	39.0	\$ 4484
	40-1596WM Six Doors	96	15	17 1/16	-	-	138	36.8	\$ 4305
	40-1590WM Five Doors	90	15	17 1/16	-	-	150	34.5	\$ 3978
	40-1584WM Five Doors	84	15	17 1/16	-	-	140	32.3	\$ 3677
	40-1578WM Four Doors	78	15	17 1/16	-	-	130	15.0	\$ 3385
	40-1572WM Four Doors	72	15	17 1/16	-	-	120	13.9	\$ 3061
	40-1566WM Four Doors	66	15	17 1/16	-	-	110	12.8	\$ 2956
	40-1560WM Four Doors	60	15	17 1/16	-	-	100	11.6	\$ 2769
	40-1554WM Three Doors	54	15	17 1/16	-	-	90	10.5	\$ 2479
	40-1548WM Three Doors	48	15	17 1/16	-	-	80	9.4	\$ 2256
	40-1542WM Two Doors	42	15	17 1/16	-	-	70	8.3	\$ 1923
	40-1536WM Two Doors	36	15	17 1/16	-	-	60	7.2	\$ 1762

Description

- Mounts to Wall with Mounting Brackets Included
- Storage Behind Metallic Framed Frosted Acrylic Doors
- Unfinished Back

NOTE: Indiana Furniture will not be liable for wall mount hutch units that are not properly installed.

For ordering options, see back of Elevate Identification card at the beginning of section.

For tackboard and tasklights, see page 142.

Item	Model No.	W	D	H	K	R	Ship Wt	Cubic Ft	List Price
WOOD FROSTED ACRYLIC DOOR WALL MOUNT HUTCHES 	40-15108AW Six Doors	108	15	17 1/16	-	-	155	41.3	\$ 4917
	40-15102AW Six Doors	102	15	17 1/16	-	-	146	39.0	\$ 4757
	40-1596AW Six Doors	96	15	17 1/16	-	-	138	36.8	\$ 4563
	40-1590AW Five Doors	90	15	17 1/16	-	-	150	34.5	\$ 4149
	40-1584AW Five Doors	84	15	17 1/16	-	-	140	32.3	\$ 3967
	40-1578AW Four Doors	78	15	17 1/16	-	-	130	15.0	\$ 3735
	40-1572AW Four Doors	72	15	17 1/16	-	-	120	13.9	\$ 3193
	40-1566AW Four Doors	66	15	17 1/16	-	-	110	12.8	\$ 3098
	40-1560AW Four Doors	60	15	17 1/16	-	-	100	11.6	\$ 2920
	40-1554AW Three Doors	54	15	17 1/16	-	-	90	10.5	\$ 2619
	40-1548AW Three Doors	48	15	17 1/16	-	-	80	9.4	\$ 2485
	40-1542AW Two Doors	42	15	17 1/16	-	-	70	8.3	\$ 2092
	40-1536AW Two Doors	36	15	17 1/16	-	-	60	7.2	\$ 1822

Description

- Mounts to Wall with Mounting Brackets Included
- Storage Behind Wood Framed Frosted Acrylic Doors
- Unfinished Back

NOTE: Indiana Furniture will not be liable for wall mount hutch units that are not properly installed.

For ordering options, see back of Elevate Identification card at the beginning of section.

For tackboard and tasklights, see page 142.

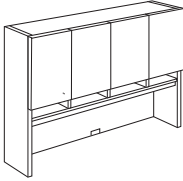
Item	Model No.	W	D	H	K	R	Ship Wt	Cubic Ft	List Price
VENEER DOOR SURFACE MOUNT HUTCHES PAPERSLOTS 	40-15108THUS Six Doors	108	15	52 7/8	-	-	313	64.2	\$ 7126
	40-15102THUS Six Doors	102	15	52 7/8	-	-	296	60.7	\$ 6992
	40-1596THUS Six Doors	96	15	52 7/8	-	-	278	57.7	\$ 6790
	40-1590THUS Five Doors	90	15	52 7/8	-	-	260	53.7	\$ 6257
	40-1584THUS Five Doors	84	15	52 7/8	-	-	243	50.2	\$ 5885
	40-1578THUS Four Doors	78	15	52 7/8	-	-	226	46.7	\$ 5231
	40-1572THUS Four Doors	72	15	52 7/8	-	-	264	43.3	\$ 4828
	40-1566THUS Four Doors	66	15	52 7/8	-	-	242	39.7	\$ 4633
	40-1560THUS Four Doors	60	15	52 7/8	-	-	220	36.2	\$ 4300
	40-1554THUS Three Doors	54	15	52 7/8	-	-	198	30.9	\$ 4001
	40-1548THUS Three Doors	48	15	52 7/8	-	-	176	27.5	\$ 3562
	40-1542THUS Two Doors	42	15	52 7/8	-	-	154	24.2	\$ 2978
	40-1536THUS Two Doors	36	15	52 7/8	-	-	132	20.9	\$ 2708

Description

- Storage Behind Wood Doors
- One Fixed Shelf Behind Doors
- Overall Installed Height 83"
- Paperslots
- Grommet
- Unfinished Back
- 19 1/4" Clearance Below Paperslots

For ordering options, see back of Elevate Identification card at the beginning of section.

For tackboard and tasklights, see page 142.

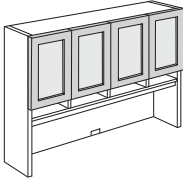
Item	Model No.	W	D	H	K	R	Ship Wt	Cubic Ft	List Price
METALLIC FROSTED ACRYLIC DOOR SURFACE MOUNT HUTCHES PAPERSLOTS 	40-15108THMS Six Doors	108	15	52 7/8	-	-	313	64.2	\$ 7923
	40-15102THMS Six Doors	102	15	52 7/8	-	-	296	60.7	\$ 7766
	40-1596THMS Six Doors	96	15	52 7/8	-	-	278	57.7	\$ 7496
	40-1590THMS Five Doors	90	15	52 7/8	-	-	260	53.7	\$ 6898
	40-1584THMS Five Doors	84	15	52 7/8	-	-	243	50.2	\$ 6490
	40-1578THMS Four Doors	78	15	52 7/8	-	-	226	46.7	\$ 5702
	40-1572THMS Four Doors	72	15	52 7/8	-	-	264	43.3	\$ 5322
	40-1566THMS Four Doors	66	15	52 7/8	-	-	242	39.7	\$ 5054
	40-1560THMS Four Doors	60	15	52 7/8	-	-	220	36.2	\$ 4712
	40-1554THMS Three Doors	54	15	52 7/8	-	-	198	30.9	\$ 4362
	40-1548THMS Three Doors	48	15	52 7/8	-	-	176	27.5	\$ 3918
	40-1542THMS Two Doors	42	15	52 7/8	-	-	154	24.2	\$ 3253
	40-1536THMS Two Doors	36	15	52 7/8	-	-	132	20.9	\$ 3006

Description

- Storage Behind Metallic Framed Frosted Acrylic Doors
- One Fixed Shelf Behind Doors
- Overall Installed Height 83"
- Paperslots
- Grommet
- Unfinished Back
- 19 1/4" Clearance Below Paperslots

For ordering options, see back of Elevate Identification card at the beginning of section.

For tackboard and tasklights, see page 142.

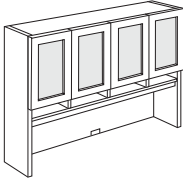
Item	Model No.	W	D	H	K	R	Ship Wt	Cubic Ft	List Price
WOOD FROSTED ACRYLIC DOOR SURFACE MOUNT HUTCHES PAPERSLOTS 	40-15108TAHS Six Doors	108	15	52 7/8	-	-	313	64.2	\$ 8068
	40-15102TAHS Six Doors	102	15	52 7/8	-	-	296	60.7	\$ 7914
	40-1596TAHS Six Doors	96	15	52 7/8	-	-	278	57.7	\$ 7671
	40-1590TAHS Five Doors	90	15	52 7/8	-	-	260	53.7	\$ 6988
	40-1584TAHS Five Doors	84	15	52 7/8	-	-	243	50.2	\$ 6603
	40-1578TAHS Four Doors	78	15	52 7/8	-	-	226	46.7	\$ 5926
	40-1572TAHS Four Doors	72	15	52 7/8	-	-	264	43.3	\$ 5374
	40-1566TAHS Four Doors	66	15	52 7/8	-	-	242	39.7	\$ 5129
	40-1560TAHS Four Doors	60	15	52 7/8	-	-	220	36.2	\$ 4794
	40-1554TAHS Three Doors	54	15	52 7/8	-	-	198	30.9	\$ 4417
	40-1548TAHS Three Doors	48	15	52 7/8	-	-	176	27.5	\$ 4034
	40-1542TAHS Two Doors	42	15	52 7/8	-	-	154	24.2	\$ 3340
	40-1536TAHS Two Doors	36	15	52 7/8	-	-	132	20.9	\$ 3059

Description

- Storage Behind Wood Framed Frosted Acrylic Doors
- One Fixed Shelf Behind Doors
- Overall Installed Height 83"
- Paperslots
- Grommet
- Unfinished Back
- 19 1/4" Clearance Below Paperslots

For ordering options, see back of Elevate Identification card at the beginning of section.

For tackboard and tasklights, see page 142.

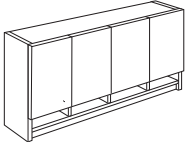
Item	Model No.	W	D	H	K	R	Ship Wt	Cubic Ft	List Price
VENEER DOOR WALL MOUNT HUTCHES PAPERSLOTS 	40-15108TWDS Six Doors	108	15	33 5/8	-	-	281	55.1	\$ 6657
	40-15102TWDS Six Doors	102	15	33 5/8	-	-	265	60.7	\$ 6498
	40-1596TWDS Six Doors	96	15	33 5/8	-	-	249	57.2	\$ 6309
	40-1590TWDS Five Doors	90	15	33 5/8	-	-	233	53.7	\$ 5784
	40-1584TWDS Five Doors	84	15	33 5/8	-	-	217	50.2	\$ 5385
	40-1578TWDS Four Doors	78	15	33 5/8	-	-	201	28.3	\$ 4796
	40-1572TWDS Four Doors	72	15	33 5/8	-	-	185	43.2	\$ 4377
	40-1566TWDS Four Doors	66	15	33 5/8	-	-	170	22.0	\$ 4247
	40-1560TWDS Four Doors	60	15	33 5/8	-	-	155	20.1	\$ 3892
	40-1554TWDS Three Doors	54	15	33 5/8	-	-	140	18.1	\$ 3545
	40-1548TWDS Three Doors	48	15	33 5/8	-	-	124	16.2	\$ 3257
	40-1542TWDS Two Doors	42	15	33 5/8	-	-	109	14.2	\$ 2780
	40-1536TWDS Two Doors	36	15	33 5/8	-	-	93	12.3	\$ 2566

Description

- Mounts to Wall with Mounting Brackets Included
- Storage Behind Wood Grained Doors
- One Fixed Shelf Behind Doors
- Paperslots
- Unfinished Back

NOTE: Indiana Furniture will not be liable for wall mount hutch units that are not properly installed.

For ordering options, see back of Elevate Identification card at the beginning of section.

For tackboard and tasklights, see page 142.

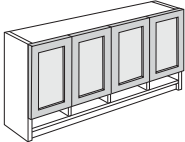
Item	Model No.	W	D	H	K	R	Ship Wt	Cubic Ft	List Price
METALLIC FROSTED ACRYLIC DOOR WALL MOUNT HUTCHES PAPERSLOTS 	40-15108TWMS Six Doors	108	15	33 5/8	-	-	281	55.1	\$ 7385
	40-15102TWMS Six Doors	102	15	33 5/8	-	-	265	60.7	\$ 7179
	40-1596TWMS Six Doors	96	15	33 5/8	-	-	249	57.2	\$ 7000
	40-1590TWMS Five Doors	90	15	33 5/8	-	-	233	53.7	\$ 6251
	40-1584TWMS Five Doors	84	15	33 5/8	-	-	217	50.2	\$ 5918
	40-1578TWMS Four Doors	78	15	33 5/8	-	-	201	28.3	\$ 5385
	40-1572TWMS Four Doors	72	15	33 5/8	-	-	185	43.2	\$ 4815
	40-1566TWMS Four Doors	66	15	33 5/8	-	-	170	22.0	\$ 4648
	40-1560TWMS Four Doors	60	15	33 5/8	-	-	155	20.1	\$ 4304
	40-1554TWMS Three Doors	54	15	33 5/8	-	-	140	18.1	\$ 3871
	40-1548TWMS Three Doors	48	15	33 5/8	-	-	124	16.2	\$ 3608
	40-1542TWMS Two Doors	42	15	33 5/8	-	-	109	14.2	\$ 3016
	40-1536TWMS Two Doors	36	15	33 5/8	-	-	93	12.3	\$ 2642

Description

- Mounts to Wall with Mounting Brackets Included
- Storage Behind Metallic Framed Frosted Acrylic Doors
- One Fixed Shelf Behind Doors
- Paperslots
- Unfinished Back

NOTE: Indiana Furniture will not be liable for wall mount hutch units that are not properly installed.

For ordering options, see back of Elevate Identification card at the beginning of section.

For tackboard and tasklights, see page 142.

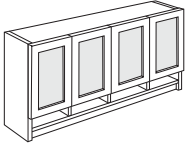
Item	Model No.	W	D	H	K	R	Ship Wt	Cubic Ft	List Price
WOOD FROSTED ACRYLIC DOOR WALL MOUNT HUTCHES PAPERSLOTS 	40-15108TAWS Six Doors	108	15	33 5/8	-	-	281	55.1	\$ 7516
	40-15102TAWS Six Doors	102	15	33 5/8	-	-	265	60.7	\$ 7311
	40-1596TAWS Six Doors	96	15	33 5/8	-	-	249	57.2	\$ 7149
	40-1590TAWS Five Doors	90	15	33 5/8	-	-	233	53.7	\$ 6404
	40-1584TAWS Five Doors	84	15	33 5/8	-	-	217	50.2	\$ 6106
	40-1578TAWS Four Doors	78	15	33 5/8	-	-	201	28.3	\$ 5502
	40-1572TAWS Four Doors	72	15	33 5/8	-	-	185	43.2	\$ 4960
	40-1566TAWS Four Doors	66	15	33 5/8	-	-	170	22.0	\$ 4716
	40-1560TAWS Four Doors	60	15	33 5/8	-	-	155	20.1	\$ 4380
	40-1554TAWS Three Doors	54	15	33 5/8	-	-	140	18.1	\$ 3966
	40-1548TAWS Three Doors	48	15	33 5/8	-	-	124	16.2	\$ 3702
	40-1542TAWS Two Doors	42	15	33 5/8	-	-	109	14.2	\$ 3109
	40-1536TAWS Two Doors	36	15	33 5/8	-	-	93	12.3	\$ 2726

Description

- Mounts to Wall with Mounting Brackets Included
- Storage Behind Wood Framed Frosted Acrylic Doors
- One Fixed Shelf Behind Doors
- Paperslots
- Unfinished Back

NOTE: Indiana Furniture will not be liable for wall mount hutch units that are not properly installed.

For ordering options, see back of Elevate Identification card at the beginning of section.

For tackboard and tasklights, see page 142.

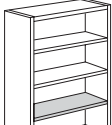
Item	Model No.	W	D	H	K	R	Ship Wt	Cubic Ft	List Price
BOOKCASES 	40-3672BC Three Adjustable Shelves - One Fixed Shelf	36	15	70 5/16	-	-	185	27.7	W \$ 2911
	40-3648BC Two Adjustable Shelves	36	15	48	-	-	139	18.7	P \$ 2424 W \$ 2450
	40-3630BC One Adjustable Shelf	36	15	30	-	-	85	12.0	P \$ 2008 W \$ 2032

Description

- 1" Thick Shelves

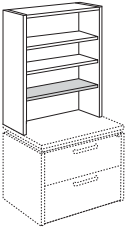
TALL TOP UNIT BOOKCASE 	40-1536TTU	36	15	52 7/8	-	-	169	22.2	\$ 2138
---	------------	----	----	--------	---	---	-----	------	---------

Description

- Fixed Bottom Shelf with 12" Clearance
- Two Adjustable Shelves
- Use on Two Drawer Lateral Files
- 1" Thick Shelves

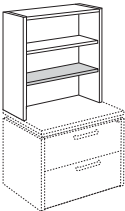
TOP UNIT BOOKCASE 	40-1536TU	36	15	40 13/16	-	-	127	16.4	\$ 1595
---	-----------	----	----	----------	---	---	-----	------	---------

Description

- Fixed Bottom Shelf with 12" Clearance
- One Adjustable Shelf
- Use on Two Drawer Lateral Files
- 1" Thick Shelves

For ordering options, see back of Elevate Identification card at the beginning of section.

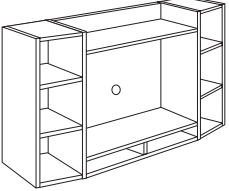
Item	Model No.	W	D	H	K	R	Ship Wt	Cubic Ft	List Price
FLAT PANEL TV HUTCH 	40-1572HFP	72	15	40 ¹³ / ₁₆	-	-	201	34.1	\$ 3689
	40-1566HFP	66	15	40 ¹³ / ₁₆	-	-	184	31.2	\$ 3508

Description

- Designed to Hold Freestanding TV's
- 72" Model Center Section Measures 30"H x 49"W
- 66" Model Center Section Measures 30"H x 43"W
- Center Section has 4" Divided Opening at the Bottom and a 5 ³/₈" Open Shelf at the Top
- Angled Shelving on Each Side with Two Fixed Shelves

NOTE: Indiana Furniture will not be liable for TV's mounted on the hutch.
 NOTE: Optional hutch top will not work due to the design of this unit.

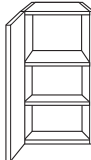
VENEER DOOR STORAGE TOWER 	Hinged Left	Hinged Right	W	D	H	K	R	Ship Wt	Cubic Ft	List Price
	40-1518HL3	40-1518HR3	18	15	40 ¹³ / ₁₆	-	-	78	8.6	\$ 1847

Description

- Storage Behind Veneer Door with Two Adjustable Shelves

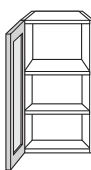
METALLIC FROSTED ACRYLIC DOOR STORAGE TOWER 	Hinged Left	Hinged Right	W	D	H	K	R	Ship Wt	Cubic Ft	List Price
	40-1518MHL3	40-1518MHR3	18	15	40 ¹³ / ₁₆	-	-	78	8.6	\$ 2048

Description

- Storage Behind Metallic Framed Frosted Acrylic Door with Two Adjustable Shelves

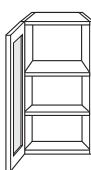
WOOD FROSTED ACRYLIC DOOR STORAGE TOWER 	Hinged Left	Hinged Right	W	D	H	K	R	Ship Wt	Cubic Ft	List Price
	40-1518AHL3	40-1518AHR3	18	15	40 ¹³ / ₁₆	-	-	78	8.6	\$ 2130

Description

- Storage Behind Wood Framed Frosted Acrylic Door with Two Adjustable Shelves

For ordering options, see back of Elevate Identification card at the beginning of section.

Item	Model No.	W	D	H	K	R	Ship Wt	Cubic Ft	List Price	
VENEER DOOR TALL STORAGE TOWER	Hinged Left									
	Hinged Right									
	40-1518THL1	40-1518THR1	18	15	52 7/8	-	-	95	11.0	\$ 2427

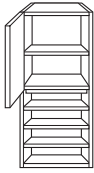
Description

- Storage Behind Veneer Door
- Three Adjustable Shelves in Lower Section
- One Adjustable Shelf in Top Section

METALLIC FROSTED ACRYLIC DOOR TALL STORAGE TOWER	Hinged Left									
	Hinged Right									
	40-1518MTHL1	40-1518MTHR1	18	15	52 7/8	-	-	95	11.0	\$ 2522

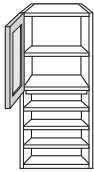
Description

- Storage Behind Metallic Framed Frosted Acrylic Door
- Three Adjustable Shelves in Lower Section
- One Adjustable Shelf in Top Section

WOOD FROSTED ACRYLIC DOOR TALL STORAGE TOWER	Hinged Left									
	Hinged Right									
	40-1518ATHL1	40-1518ATHR1	18	15	52 7/8	-	-	95	11.0	\$ 2543

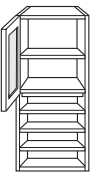
Description

- Storage Behind Wood Framed Frosted Acrylic Door
- Three Adjustable Shelves in Lower Section
- One Adjustable Shelf in Top Section

For ordering options, see back of Elevate Identification card at the beginning of section.

Item	Model No.	W	D	H	K	R	Ship Wt	Cubic Ft	List Price	
VENEER DOOR STORAGE TOWER	Hinged Left									
	Hinged Right									
	40-1518HL1	40-1518HR1	18	15	40 ¹³ / ₁₆	-	-	78	8.6	\$ 1929

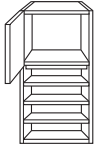
Description

- Storage Behind Veneer Door
- Three Adjustable Shelves in Lower Section

METALLIC FROSTED ACRYLIC DOOR STORAGE TOWER	Hinged Left									
	Hinged Right									
	40-1518MHL1	40-1518MHR1	18	15	40 ¹³ / ₁₆	-	-	78	8.6	\$ 1998

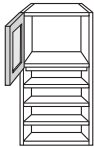
Description

- Storage Behind Metallic Framed Frosted Acrylic Door
- Three Adjustable Shelves in Lower Section

WOOD FROSTED ACRYLIC DOOR STORAGE TOWER	Hinged Left									
	Hinged Right									
	40-1518AHL1	40-1518AHR1	18	15	40 ¹³ / ₁₆	-	-	78	8.6	\$ 2050

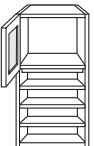
Description

- Storage Behind Wood Framed Frosted Acrylic Door
- Three Adjustable Shelves in Lower Section

For ordering options, see back of Elevate Identification card at the beginning of section.

Item	Model No.	W	D	H	K	R	Ship Wt	Cubic Ft	List Price
WARDROBE/STORAGE CABINET	40-3672WD	36	24	70 5/16	-	-	290	42.0	\$ 5361

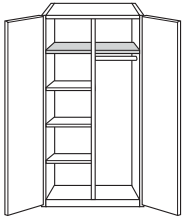

Description

- Storage Behind Two Veneer Doors
- Fixed Top Shelf Behind Each Door
- Three Adjustable Shelves on Left Side
- Coat Rod on Right Side

Options: Specify & Add

Optional Locking	\$ 43
------------------	-------

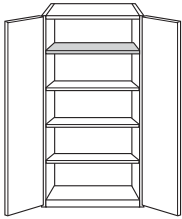
WARDROBE/STORAGE CABINET	40-3672SD	36	24	70 5/16	-	-	290	42.0	\$ 5102
--------------------------	-----------	----	----	---------	---	---	-----	------	---------

Description

- Storage Behind Two Veneer Doors
- Fixed Top Shelf Behind Each Door
- Three Adjustable 1" Thick Shelves

WARDROBE/STORAGE CABINET	Hinged Left	Hinged Right	W	D	H	K	R	Ship Wt	Cubic Ft	List Price
	40-1872WL	40-1872WR	18	24	70 5/16	-	-	175	23.0	\$ 3598

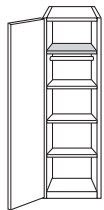
Description

- Fixed Top Shelf
- Coat Rod Under Fixed Shelf
- Three Adjustable Shelves
- Adjustable Shelves can be Removed for Wardrobe Applications

Options: Specify & Add

Optional Locking	\$ 43
------------------	-------

For ordering options, see back of Elevate Identification card at the beginning of section.

Item	Model No.	W	D	H	K	R	Ship Wt	Cubic Ft	List Price	
VENEER DOOR STORAGE CABINET	Hinged Left									
	Hinged Right									
	40-1872SL	40-1872SR	18	24	70 ⁵ / ₁₆	-	-	175	23.0	\$ 3694

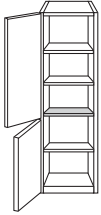
Description

- Veneer Doors Provide Storage
- Two Adjustable Shelves in Upper Section
- One Adjustable Shelf in Lower Section

METALLIC FROSTED ACRYLIC DOOR STORAGE CABINET	Hinged Left	Hinged Right	W	D	H	K	R	Ship Wt	Cubic Ft	List Price
		40-1872MSL	40-1872MSR	18	24	70 ⁵ / ₁₆	-	-	175	23.0

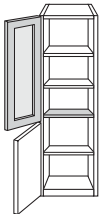
Description

- Upper Storage is Provided by Metallic Framed Frosted Acrylic Door with Two Adjustable Shelves
- Lower Storage is Provided by Veneer Door with One Adjustable Shelf

WOOD FROSTED ACRYLIC DOOR STORAGE CABINET	Hinged Left	Hinged Right	W	D	H	K	R	Ship Wt	Cubic Ft	List Price
		40-1872ASL	40-1872ASR	18	24	70 ⁵ / ₁₆	-	-	175	23.0

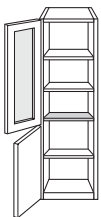
Description

- Upper Storage is Provided by Wood Framed Frosted Acrylic Door with Two Adjustable Shelves
- Lower Storage is Provided by Veneer Door with One Adjustable Shelf

For ordering options, see back of Elevate Identification card at the beginning of section.

Item	Model No.	W	D	H	K	R	Ship Wt	Cubic Ft	List Price	
VENEER DOOR STORAGE CABINET	Hinged Left									
	Hinged Right									
	40-1872WFL	40-1872WFR	18	24	70 ⁵ / ₁₆	-	-	145	22.0	\$ 3835

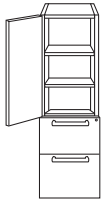

Description

- Upper Storage is Provided by Veneer Door with Two Adjustable Shelves
- Lower Storage is Provided by Two File Drawers
- Locking File Drawers Provide Legal or Letter Filing
- Optional Locking Available for Upper Storage

Options: Specify & Add

Optional Door Locking	\$ 43
-----------------------	-------

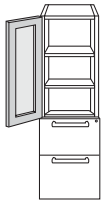
METALLIC FROSTED ACRYLIC DOOR STORAGE CABINET	Hinged Left									
	Hinged Right									
	40-1872MWFL	40-1872MWFR	18	24	70 ⁵ / ₁₆	-	-	145	22.0	\$ 4011

Description

- Upper Storage is Provided by Metallic Framed Frosted Acrylic Door with Two Adjustable Shelves
- Lower Storage is Provided by Two File Drawers
- Locking File Drawers Provide Legal or Letter Filing
- Optional Locking Available for Upper Storage

Options: Specify & Add

Optional Door Locking	\$ 43
-----------------------	-------

WOOD FROSTED ACRYLIC DOOR STORAGE CABINET	Hinged Left									
	Hinged Right									
	40-1872AWFL	40-1872AWFR	18	24	70 ⁵ / ₁₆	-	-	145	22.0	\$ 4117

Description

- Upper Storage is Provided by Wood Framed Frosted Acrylic Door with Two Adjustable Shelves
- Lower Storage is Provided by Two File Drawers
- Locking File Drawers Provide Legal or Letter Filing
- Optional Locking Available for Upper Storage

Options: Specify & Add

Optional Door Locking	\$ 43
-----------------------	-------

For ordering options, see back of Elevate Identification card at the beginning of section.

Item	Model No.	W	D	H	K	R	Ship Wt	Cubic Ft	List Price	
VENEER DOOR STORAGE CABINET	Hinged Left									
	Hinged Right									
	40-1872WBL	40-1872WBR	18	24	70 ⁵ / ₁₆	-	-	145	22.0	\$ 3835



Description

- Upper Storage is Provided by Veneer Door with Two Adjustable Shelves
- Lower Storage is Provided by Box/Box/File Drawers
- File Drawer Provides Legal or Letter Filing
- Locking Drawers
- Optional Locking Available for Upper Storage

Options: Specify & Add

Optional Door Locking	\$ 43
-----------------------	-------

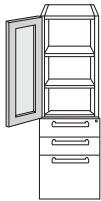
METALLIC FROSTED ACRYLIC DOOR STORAGE CABINET	Hinged Left									
	Hinged Right									
	40-1872MWBL	40-1872MWBR	18	24	70 ⁵ / ₁₆	-	-	145	22.0	\$ 4011

Description

- Upper Storage is Provided by Metallic Framed Frosted Acrylic Door with Two Adjustable Shelves
- Lower Storage is Provided by Box/Box/File Drawers
- File Drawer Provides Legal or Letter Filing
- Locking Drawers
- Optional Locking Available for Upper Storage

Options: Specify & Add

Optional Door Locking	\$ 43
-----------------------	-------

WOOD FROSTED ACRYLIC DOOR STORAGE CABINET	Hinged Left									
	Hinged Right									
	40-1872AWBL	40-1872AWBR	18	24	70 ⁵ / ₁₆	-	-	145	22.0	\$ 4117



Description

- Upper Storage is Provided by Wood Framed Frosted Acrylic Door with Two Adjustable Shelves
- Lower Storage is Provided by Box/Box/File Drawers
- File Drawer Provides Legal or Letter Filing
- Locking Drawers
- Optional Locking Available for Upper Storage

Options: Specify & Add

Optional Door Locking	\$ 43
-----------------------	-------

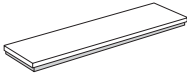
For ordering options, see back of Elevate Identification card at the beginning of section.

Item	Model No.	W	D	H	K	R	Ship Wt	Cubic Ft	List Price
OPTIONAL OVERHEAD TOP FOR 15" DEEP UNITS 	40-15108HT	108	15	1 ⁵ / ₁₆	-	-	67	5.7	\$ 688
	40-15102HT	102	15	1 ⁵ / ₁₆	-	-	63	5.4	\$ 671
	40-1596HT	96	15	1 ⁵ / ₁₆	-	-	60.5	5.1	\$ 650
	40-1590HT	90	15	1 ⁵ / ₁₆	-	-	56.7	4.8	\$ 624
	40-1584HT	84	15	1 ⁵ / ₁₆	-	-	53	4.5	\$ 604
	40-1578HT	78	15	1 ⁵ / ₁₆	-	-	49.5	4.2	\$ 582
	40-1572HT	72	15	1 ⁵ / ₁₆	-	-	48	3.9	\$ 529
	40-1566HT	66	15	1 ⁵ / ₁₆	-	-	41.5	3.5	\$ 508
	40-1560HT	60	15	1 ⁵ / ₁₆	-	-	37.8	3.2	\$ 487
	40-1554HT	54	15	1 ⁵ / ₁₆	-	-	34	2.9	\$ 448
	40-1548HT	48	15	1 ⁵ / ₁₆	-	-	30	2.6	\$ 419
	40-1542HT	42	15	1 ⁵ / ₁₆	-	-	26.5	2.3	\$ 397
	40-1536HT	36	15	1 ⁵ / ₁₆	-	-	23	2.0	\$ 360
	40-1518HT	18	15	1 ⁵ / ₁₆	-	-	11	1.0	\$ 295

Description

- Provides an Edge Profile on Overhead Units While Giving Multiple Overhead Units a Cohesive Appearance
- Profiled on All Sides
- Not Intended for Open Hutches

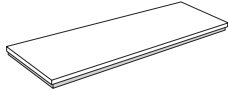
OPTIONAL OVERHEAD TOP FOR 24" DEEP UNITS 	40-2436HT	36	24	1 ⁵ / ₁₆	-	-	37	2.9	\$ 462
	40-2418HT	18	24	1 ⁵ / ₁₆	-	-	18	1.5	\$ 358

Description

- Provides an Edge Profile on Overhead Units While Giving Multiple Overhead Units a Cohesive Appearance
- Profiled on All Sides
- Not Intended for Open Hutches

For ordering options, see back of Elevate Identification card at the beginning of section.

Item	Model No.	W	D	H	K	R	Ship Wt	Cubic Ft	List Price
COMPUTER WORKSTATION	40-2442CW	42	24	27	-	-	115	19.2	P \$ 1635 W \$ 1683

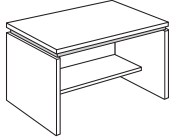

Description

- Fixed Shelf in Kneespace
- Grommet in Back Panel

Options: Specify & Add

CS-40BL	Optional Casters	\$ 150
---------	------------------	--------

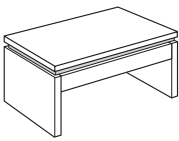
MAGAZINE TABLE	40-2442MT	42	24	16	-	-	76	7.5	P \$ 1093 W \$ 1141
----------------	-----------	----	----	----	---	---	----	-----	------------------------

Description

- Ships Assembled

END TABLE	40-2424ET	24	24	22	-	-	50	9.3	P \$ 959 W \$ 1063
-----------	-----------	----	----	----	---	---	----	-----	-----------------------

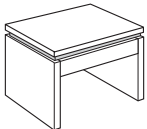
Description

- Ships Assembled

CENTER DRAWER	40-1622CD	22	16	2 3/4	-	-	7	1.4	\$ 202
---------------	-----------	----	----	-------	---	---	---	-----	--------

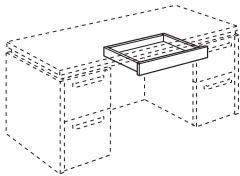

Description

- Fits Desks, P-Top Units, and D-Top Units
- Will Not Work in Conjunction with Modesty Panels on 30" D-Top Units
- Built In Pen Tray

Options: Specify & Add

Factory Installed	\$ 130
-------------------	--------

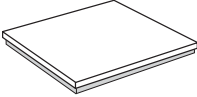
For ordering options, see back of Elevate Identification card at the beginning of section.

Item	Model No.	W	D	H	K	R	Ship Wt	Cubic Ft	List Price
SQUARE CONFERENCE TABLE TOPS 	40-4848SQT	48	48	1 ⁵ / ₁₆	-	-	82	7.2	P \$ 654 W \$ 854
	40-4242SQT	42	42	1 ⁵ / ₁₆	-	-	72	5.6	P \$ 573 W \$ 709
	40-3636SQT	36	36	1 ⁵ / ₁₆	-	-	62	4.2	P \$ 474 W \$ 546

Description

- Accommodates 4 Chairs
- Base Must be Specified Separately

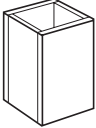
SQUARE TABLE BASE 	40-2020SB	20	20	28 1/4	-	-	39	8.4	\$ 898	
	For Use on 48" and 42" Square Tops									
	40-1616SB	16	16	28 1/4	-	-	39	5.6	\$ 844	
	For Use on 36" Square Tops									

Description

- Veneer Square Base
- Weighted for Stability
- 2 Wire Management Grommets Standard at Top with 8" Opening Standard in Bottom

SQUARE TABLE LEGS 	40-0303SWL	3	3	28 1/4	-	-	31	3.2	\$ 557
--	------------	---	---	--------	---	---	----	-----	--------

Description

- Four Hardwood Legs

For ordering options, see back of Elevate Identification card at the beginning of section.

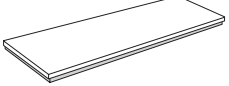
Item	Model No.	W	D	H	K	R	Ship Wt	Cubic Ft	List Price
OPTIONAL CREENZA TOP FOR 24" DEEP UNITS 	40-24108TP	108	24	1 ⁵ / ₁₆	-	-	104	8.3	P \$ 882 W \$ 958
	40-24102TP	102	24	1 ⁵ / ₁₆	-	-	98	7.8	P \$ 836 W \$ 906
	40-2496TP	96	24	1 ⁵ / ₁₆	-	-	92	7.4	P \$ 770 W \$ 863
	40-2490TP	90	24	1 ⁵ / ₁₆	-	-	86	6.9	P \$ 747 W \$ 846
	40-2484TP	84	24	1 ⁵ / ₁₆	-	-	81	6.5	P \$ 720 W \$ 826
	40-2478TP	78	24	1 ⁵ / ₁₆	-	-	75	6.0	P \$ 699 W \$ 807
	40-2472TP	72	24	1 ⁵ / ₁₆	-	-	69	5.6	P \$ 633 W \$ 724
	40-2466TP	66	24	1 ⁵ / ₁₆	-	-	63	5.1	P \$ 595 W \$ 682
	40-2460TP	60	24	1 ⁵ / ₁₆	-	-	58	4.7	P \$ 569 W \$ 616
	40-2454TP	54	24	1 ⁵ / ₁₆	-	-	52	4.2	P \$ 547 W \$ 588
	40-2448TP	48	24	1 ⁵ / ₁₆	-	-	46	3.8	P \$ 465 W \$ 522
	40-2442TP	42	24	1 ⁵ / ₁₆	-	-	40	3.3	P \$ 445 W \$ 493
	40-2436TP	36	24	1 ⁵ / ₁₆	-	-	35	2.9	P \$ 425 W \$ 474
	40-2430TP	30	24	1 ⁵ / ₁₆	-	-	29	2.4	P \$ 394 W \$ 435
	40-2418TP	18	24	1 ⁵ / ₁₆	-	-	17	1.5	P \$ 343 W \$ 358

Description

- For Use as a Credenza Top
- Profiled on Four Sides
- Grain Runs Left to Right
- If Modular Tops have a Kneespace of 60" or Greater, a Support T is Required, See Page 138
- For Table Lift Options, See Accessories

For ordering options, see back of Elevate Identification card at the beginning of section.

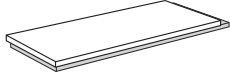
Item	Model No.	W	D	H	K	R	Ship Wt	Cubic Ft	List Price	
OPTIONAL RETURN TOP FOR 24" DEEP UNITS 	Left Top	Right Top								
	40-24108RTL	40-24108RTR	108	24	1 ⁵ / ₁₆	-	-	104	8.3	P \$ 882 W \$ 958
	40-24102RTL	40-24102RTR	102	24	1 ⁵ / ₁₆	-	-	98	7.8	P \$ 836 W \$ 906
	40-2496RTL	40-2496RTR	96	24	1 ⁵ / ₁₆	-	-	92	7.4	P \$ 770 W \$ 863
	40-2490RTL	40-2490RTR	90	24	1 ⁵ / ₁₆	-	-	86	6.9	P \$ 747 W \$ 846
	40-2484RTL	40-2484RTR	84	24	1 ⁵ / ₁₆	-	-	81	6.5	P \$ 720 W \$ 826
	40-2478RTL	40-2478RTR	78	24	1 ⁵ / ₁₆	-	-	75	6.0	P \$ 699 W \$ 807
	40-2472RTL	40-2472RTR	72	24	1 ⁵ / ₁₆	-	-	69	5.6	P \$ 633 W \$ 724
	40-2466RTL	40-2466RTR	66	24	1 ⁵ / ₁₆	-	-	63	5.1	P \$ 595 W \$ 682
	40-2460RTL	40-2460RTR	60	24	1 ⁵ / ₁₆	-	-	58	4.7	P \$ 569 W \$ 616
	40-2454RTL	40-2454RTR	54	24	1 ⁵ / ₁₆	-	-	52	4.2	P \$ 547 W \$ 588
	40-2448RTL	40-2448RTR	48	24	1 ⁵ / ₁₆	-	-	46	3.8	P \$ 465 W \$ 522
	40-2442RTL	40-2442RTR	42	24	1 ⁵ / ₁₆	-	-	40	3.3	P \$ 445 W \$ 493
	40-2436RTL	40-2436RTR	36	24	1 ⁵ / ₁₆	-	-	35	2.9	P \$ 425 W \$ 474

Description

- For Use as a Return Top
- Profiled on Four Sides
- Grain Runs Front to Back
- If Modular Tops have a Kneespace of 60" or Greater, a Support T is Required, See Page 138

For ordering options, see back of Elevate Identification card at the beginning of section.

ELEVATE™ 4000 SERIES
 Modular Components

Item	Model No.	W	D	H	K	R	Ship Wt	Cubic Ft	List Price
COMPONENT PEDESTAL BOX/BOX/FILE	40-2418PD1	18	24	28 1/4	-	-	82	9.4	\$ 1517

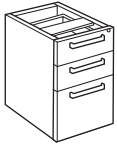
Description

- Used to Construct Credenzas or Returns
- Finished Back
- File Drawer Provides Legal or Letter Filing
- Legal Width Pedestal
- Component Top Must be Specified Separately
- Locking

COMPONENT PEDESTAL FILE/FILE	40-2418PD2	18	24	28 1/4	-	-	82	9.4	\$ 1517
---------------------------------	------------	----	----	--------	---	---	----	-----	---------

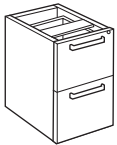
Description

- Used to Construct Credenzas or Returns
- Finished Back
- File Drawer Provides Legal or Letter Filing
- Legal Width Pedestal
- Component Top Must be Specified Separately
- Locking

COMPONENT PEDESTAL FALSE PEDESTAL	Left Ped	Right Ped	W	D	H	K	R	Ship Wt	Cubic Ft	List Price
	40-2418PD3L	40-2418PD3R	18	24	28 1/4	-	-	40	9.4	\$ 827

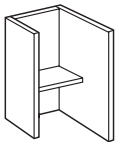
Description

- Used to Construct Credenzas or Returns
- Finished Back
- Middle Shelf for Support and Storage
- Component Top Must be Specified Separately

For ordering options, see back of Elevate Identification card at the beginning of section.

Item	Model No.	W	D	H	K	R	Ship Wt	Cubic Ft	List Price
COMPONENT PEDESTAL DOOR BOOKCASE	Left Ped								
	Right Ped								
	40-2418PD4L	18	24	28 1/4	-	-	82	9.4	\$ 1486

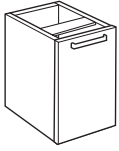
Description

- Used to Construct Credenzas or Returns
- Finished Back
- Adjustable Shelf
- Locking
- Component Top Must be Specified Separately

COMPONENT PEDESTAL LATERAL FILE	40-2436LF1	36	24	28 1/4	-	-	143	17.2	\$ 2092
	40-2430LF1	30	24	28 1/4	-	-	119	14.4	\$ 2035

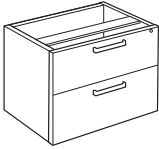
Description

- Used to Construct Credenzas or Returns
- Finished Back
- Locking
- Anti-Tilt System
- Component Top Must be Specified Separately

COMPONENT PEDESTAL DOUBLE DOOR BOOKCASE	40-2436DB	36	24	28 1/4	-	-	145	17.2	\$ 1884
	40-2430DB	30	24	28 1/4	-	-	105	14.4	\$ 1794

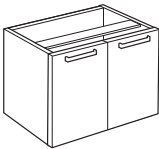
Description

- Used to Construct Credenzas or Returns
- Adjustable 12 1/8" Deep Shelf
- Finished Back
- Component Top Must be Specified Separately

For ordering options, see back of Elevate Identification card at the beginning of section.

ELEVATE™ 4000 SERIES
 Modular Components

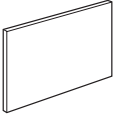
Item	Model No.	W	D	H	K	R	Ship Wt	Cubic Ft	List Price
OPTIONAL MODESTY PANEL 	40-5428BP	54	3/4	28 1/4	-	-	65	3.7	\$ 628
	40-4828BP	48	3/4	28 1/4	-	-	55	3.3	\$ 528
	40-4228BP	42	3/4	28 1/4	-	-	50	2.9	\$ 488
	40-3628BP	36	3/4	28 1/4	-	-	28	2.7	\$ 417
	40-3028BP	30	3/4	28 1/4	-	-	30	2.1	\$ 376
	40-2428BP	24	3/4	28 1/4	-	-	18	1.7	\$ 333
	40-1828BP	18	3/4	28 1/4	-	-	12	1.4	\$ 285
	40-1228BP	12	3/4	28 1/4	-	-	8	.7	\$ 247
	Description								
<ul style="list-style-type: none"> • Shipped with Attachment Hardware • Finished on Both Sides 									
Options: Specify & Add									
1-GRMT Optional Top-Center Grommet									\$ 48

SUPPORT T	40-1010SP	10	10	28 1/4	-	-	20	2.5	\$ 387
Description									
<ul style="list-style-type: none"> • Required for Added Support When Open Kneespace is 60" or Greater Under Worksurfaces • Shipped with Attachment Hardware • Finished on All Sides 									



For ordering options, see back of Elevate Identification card at the beginning of section.

Item	Model No.	W	D	H	K	R	Ship Wt	Cubic Ft	List Price
EXECUTIVE OFFICE	40-1	108	36	72 1/8	-	-	857	135.2	P \$ 13515 W \$ 13712

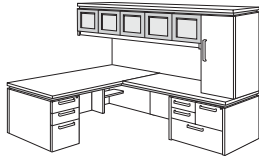

Consists of:		Qty		
40-3572LPS	1	• Single Pedestal Desk	P \$	3682
			W \$	3789
40-2472RMR	1	• Right Multi-Return	P \$	3320
			W \$	3410
40-1590WM	1	• Wall Mount Aluminum Framed Acrylic Door Hutch	\$	3978
40-1518HR3	1	• Storage Tower	\$	1847
40-15108HT	1	• Component Hutch Top	\$	688

EXECUTIVE U GROUP	40-2	108	36	72 1/8	-	-	914	159.5	P \$ 14358 W \$ 14713
-------------------	------	-----	----	--------	---	---	-----	-------	--------------------------

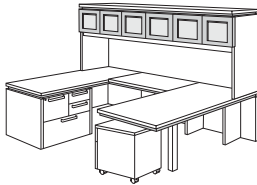

Consists of:		Qty		
40-4272RRP	1	• Right Peninsula Desk	P \$	2318
			W \$	2532
40-2442UF	1	• Bridge	P \$	1009
			W \$	1058
40-2472LMF	1	• Left Multi-File Credenza	P \$	3572
			W \$	3664
40-15108HM	1	• Acrylic Door Hutch	\$	5200
40-15108HT	1	• Component Hutch Top	\$	688
40-1622MP	1	• Mobile Ped	\$	1571

For ordering options, see back of Elevate Identification card at the beginning of section.

For grommet options, see page 102.

Item	Model No.	W	D	H	K	R	Ship Wt	Cubic Ft	List Price
EXECUTIVE OFFICE	40-3	108	36	85	-	-	1576	209.2	P \$ 27361 W \$ 27545

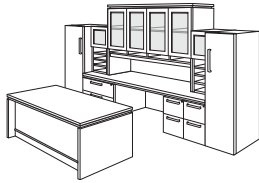

Consists of:	Qty		
40-3672DP	1	• Double Pedestal Desk	P \$ 3893 W \$ 4001
40-24108TP	1	• Component Credenza Top	P \$ 882 W \$ 958
40-2436LF1	1	• Component Lateral File	\$ 2092
40-3628BP	1	• Component Back Panel	\$ 417
40-2418PD2	2	• Component File/File Pedestal	\$ 3034
40-1872WL	1	• Wardrobe Left	\$ 3598
40-1872WR	1	• Wardrobe Right	\$ 3598
40-1518MHL1	1	• Left Hinged Storage Tower Metallic Framed Frosted Acrylic Door	\$ 1998
40-1518MHR1	1	• Right Hinged Storage Tower Metallic Framed Frosted Acrylic Door	\$ 1998
40-1572THMS	1	• Tall Metallic Framed Acrylic Door Hutch	\$ 5322
40-1572HT	1	• Component Hutch Top	\$ 529

EXECUTIVE OFFICE	40-4	72	36	84	-	-	776	121.5	P \$ 11427 W \$ 11626
------------------	------	----	----	----	---	---	-----	-------	--------------------------

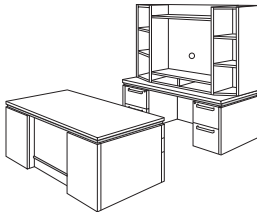

Consists of:	Qty		
40-3672DPS	1	• Stepped Front Double Pedestal Desk	P \$ 4357 W \$ 4464
40-2472KC	1	• Kneespace Credenza	P \$ 3381 W \$ 3473
40-1572HFP	1	• Flat Panel TV Hutch	\$ 3689

For ordering options, see back of Elevate Identification card at the beginning of section.

For grommet options, see page 102.

Item	Model No.	W	D	H	K	R	Ship Wt	Cubic Ft	List Price
EXECUTIVE WORKSTATION	40-5	108	84	85	-	-	865	135.2	P \$ 16176 W \$ 16486

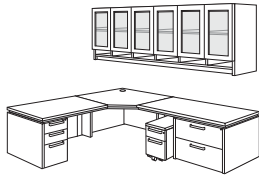
Consists of:
Qty

40-4242CU	1	• Corner Unit	P \$ 2030 W \$ 2203
40-2442LF1	1	• Left Return Box/Box/File	P \$ 1996 W \$ 2046
40-2466RTR	1	• Component Return Top Right	P \$ 595 W \$ 682
40-2436LF1	1	• Component Lateral File	\$ 2092
40-3028BP	1	• Component Backpanel	\$ 376
40-1622MP	1	• Mobile Pedestal	\$ 1571
40-15108TAWS	1	• Tall Wall-Mount Wood Framed Acrylic Door Hutch	\$ 7516

MANAGER OFFICE	40-6	72	36	30	-	-	439	74.4	P \$ 5735 W \$ 5897
----------------	------	----	----	----	---	---	-----	------	------------------------

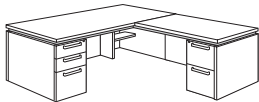
Consists of:
Qty

40-3672LPS	1	• Stepped Front Double Pedestal Desk	P \$ 3682 W \$ 3789
40-2448RF2	1	• Right Return File/File	P \$ 2053 W \$ 2108

For ordering options, see back of Elevate Identification card at the beginning of section.

For grommet options, see page 102.

TACKBOARDS: SURFACE MOUNTED HUTCHES WITHOUT PAPER SLOTS – 23" TALL

Size	Model #	COM ydg	COM, Grade 1, 2 or 3 List Price	Grade 4 List Price	Grade 5 List Price	Grade 6 List Price	Grade 7 List Price	Grade 8 List Price	Grade 9 List Price	Grade 10 List Price
36"	TB-4036H	1.25	\$ 242	\$ 355	\$ 406	\$ 463	\$ 538	\$ 617	\$ 713	\$ 821
42"	TB-4042H	1.25	\$ 249	\$ 362	\$ 414	\$ 470	\$ 545	\$ 625	\$ 720	\$ 828
48"	TB-4048H	1.50	\$ 275	\$ 411	\$ 472	\$ 540	\$ 630	\$ 725	\$ 840	\$ 969
54"	TB-4054H	1.75	\$ 306	\$ 464	\$ 536	\$ 615	\$ 720	\$ 831	\$ 965	\$ 1116
60"	TB-4060H	1.75	\$ 314	\$ 472	\$ 544	\$ 624	\$ 728	\$ 840	\$ 973	\$ 1124
66"	TB-4066H	2.00	\$ 336	\$ 518	\$ 600	\$ 690	\$ 810	\$ 937	\$ 1090	\$ 1263
72"	TB-4072H	2.25	\$ 357	\$ 561	\$ 653	\$ 755	\$ 890	\$ 1033	\$ 1204	\$ 1399
78"	TB-4078H	2.50	\$ 397	\$ 624	\$ 726	\$ 840	\$ 989	\$ 1148	\$ 1339	\$ 1555
84"	TB-4084H	2.50	\$ 404	\$ 631	\$ 734	\$ 847	\$ 996	\$ 1156	\$ 1346	\$ 1562
90"	TB-4090H	2.75	\$ 425	\$ 674	\$ 787	\$ 912	\$ 1076	\$ 1251	\$ 1461	\$ 1698
96"	TB-4096H	3.00	\$ 446	\$ 717	\$ 841	\$ 977	\$ 1156	\$ 1347	\$ 1575	\$ 1835
102"	TB-40102H	3.25	\$ 461	\$ 755	\$ 889	\$ 1036	\$ 1230	\$ 1438	\$ 1685	\$ 1966
108"	TB-40108H	3.50	\$ 478	\$ 795	\$ 939	\$ 1098	\$ 1307	\$ 1530	\$ 1797	\$ 2099

NOTE: All tackboards 78" and longer are 2 pieces.

TACKBOARDS: WALL MOUNTED HUTCHES WITHOUT PAPER SLOTS – 23" TALL

Size	Model #	COM ydg	COM, Grade 1, 2 or 3 List Price	Grade 4 List Price	Grade 5 List Price	Grade 6 List Price	Grade 7 List Price	Grade 8 List Price	Grade 9 List Price	Grade 10 List Price
36"	TB-4036W	1.25	\$ 274	\$ 387	\$ 438	\$ 495	\$ 570	\$ 649	\$ 744	\$ 853
42"	TB-4042W	1.25	\$ 281	\$ 394	\$ 446	\$ 502	\$ 577	\$ 657	\$ 752	\$ 860
48"	TB-4048W	1.50	\$ 311	\$ 447	\$ 508	\$ 576	\$ 666	\$ 761	\$ 876	\$ 1005
54"	TB-4054W	1.75	\$ 340	\$ 498	\$ 570	\$ 649	\$ 754	\$ 865	\$ 999	\$ 1150
60"	TB-4060W	2.00	\$ 357	\$ 538	\$ 620	\$ 711	\$ 830	\$ 958	\$ 1110	\$ 1283
66"	TB-4066W	2.00	\$ 383	\$ 564	\$ 646	\$ 737	\$ 856	\$ 984	\$ 1136	\$ 1309
72"	TB-4072W	2.25	\$ 405	\$ 609	\$ 702	\$ 804	\$ 938	\$ 1081	\$ 1253	\$ 1447
78"	TB-4078W	2.50	\$ 439	\$ 666	\$ 769	\$ 882	\$ 1031	\$ 1191	\$ 1381	\$ 1597
84"	TB-4084W	2.50	\$ 449	\$ 675	\$ 778	\$ 891	\$ 1040	\$ 1200	\$ 1390	\$ 1606
90"	TB-4090W	2.75	\$ 474	\$ 723	\$ 837	\$ 961	\$ 1125	\$ 1301	\$ 1510	\$ 1748
96"	TB-4096W	3.00	\$ 496	\$ 768	\$ 891	\$ 1027	\$ 1206	\$ 1397	\$ 1626	\$ 1885
102"	TB-40102W	3.25	\$ 508	\$ 803	\$ 936	\$ 1084	\$ 1278	\$ 1485	\$ 1732	\$ 2013
108"	TB-40108W	3.50	\$ 532	\$ 849	\$ 993	\$ 1151	\$ 1360	\$ 1584	\$ 1850	\$ 2153

NOTE: All tackboards 78" and longer are 2 pieces.

TASKLIGHTS – Includes 3 Wire Management Grommets

Model #	Size	Description	List Price
TL-0824	22 1/2" x 1 5/8" x 7/8"	84-LED, 7 Watts	\$ 234
TL-0848	47 1/2" x 1 5/8" x 7/8"	240-LED, 18 Watts	\$ 280

TACKBOARDS: SURFACE MOUNTED HUTCHES WITH PAPER SLOTS - 17 3/4" TALL

Size	Model #	COM ydg	COM, Grade 1, 2 or 3 List Price	Grade 4 List Price	Grade 5 List Price	Grade 6 List Price	Grade 7 List Price	Grade 8 List Price	Grade 9 List Price	Grade 10 List Price
36"	TB-4036HPS	1.25	\$ 242	\$ 355	\$ 406	\$ 463	\$ 538	\$ 617	\$ 713	\$ 821
42"	TB-4042HPS	1.25	\$ 249	\$ 362	\$ 414	\$ 470	\$ 545	\$ 625	\$ 720	\$ 828
48"	TB-4048HPS	1.50	\$ 275	\$ 411	\$ 472	\$ 540	\$ 630	\$ 725	\$ 840	\$ 969
54"	TB-4054HPS	1.75	\$ 306	\$ 464	\$ 536	\$ 615	\$ 720	\$ 831	\$ 965	\$ 1116
60"	TB-4060HPS	1.75	\$ 314	\$ 472	\$ 544	\$ 624	\$ 728	\$ 840	\$ 973	\$ 1124
66"	TB-4066HPS	2.00	\$ 336	\$ 518	\$ 600	\$ 690	\$ 810	\$ 937	\$ 1090	\$ 1263
72"	TB-4072HPS	2.25	\$ 357	\$ 561	\$ 653	\$ 755	\$ 890	\$ 1033	\$ 1204	\$ 1399
78"	TB-4078HPS	2.50	\$ 397	\$ 624	\$ 726	\$ 840	\$ 989	\$ 1148	\$ 1339	\$ 1555
84"	TB-4084HPS	2.50	\$ 404	\$ 631	\$ 734	\$ 847	\$ 996	\$ 1156	\$ 1346	\$ 1562
90"	TB-4090HPS	2.75	\$ 425	\$ 674	\$ 787	\$ 912	\$ 1076	\$ 1251	\$ 1461	\$ 1698
96"	TB-4096HPS	3.00	\$ 446	\$ 717	\$ 841	\$ 977	\$ 1156	\$ 1347	\$ 1575	\$ 1835
102"	TB-40102HPS	3.25	\$ 461	\$ 755	\$ 889	\$ 1036	\$ 1230	\$ 1438	\$ 1685	\$ 1966
108"	TB-40108HPS	3.50	\$ 478	\$ 795	\$ 939	\$ 1098	\$ 1307	\$ 1530	\$ 1797	\$ 2099

NOTE: All tackboards 78" and longer are 2 pieces.

TACKBOARDS: WALL MOUNTED HUTCHES WITH PAPER SLOTS - 17 3/4" TALL

Size	Model #	COM ydg	COM, Grade 1, 2 or 3 List Price	Grade 4 List Price	Grade 5 List Price	Grade 6 List Price	Grade 7 List Price	Grade 8 List Price	Grade 9 List Price	Grade 10 List Price
36"	TB-4036WPS	1.25	\$ 274	\$ 387	\$ 438	\$ 495	\$ 570	\$ 649	\$ 744	\$ 853
42"	TB-4042WPS	1.25	\$ 281	\$ 394	\$ 446	\$ 502	\$ 577	\$ 657	\$ 752	\$ 860
48"	TB-4048WPS	1.50	\$ 311	\$ 447	\$ 508	\$ 576	\$ 666	\$ 761	\$ 876	\$ 1005
54"	TB-4054WPS	1.75	\$ 340	\$ 498	\$ 570	\$ 649	\$ 754	\$ 865	\$ 999	\$ 1150
60"	TB-4060WPS	2.00	\$ 357	\$ 538	\$ 620	\$ 711	\$ 830	\$ 958	\$ 1110	\$ 1283
66"	TB-4066WPS	2.00	\$ 383	\$ 564	\$ 646	\$ 737	\$ 856	\$ 984	\$ 1136	\$ 1309
72"	TB-4072WPS	2.25	\$ 405	\$ 609	\$ 702	\$ 804	\$ 938	\$ 1081	\$ 1253	\$ 1447
78"	TB-4078WPS	2.50	\$ 439	\$ 666	\$ 769	\$ 882	\$ 1031	\$ 1191	\$ 1381	\$ 1597
84"	TB-4084WPS	2.50	\$ 449	\$ 675	\$ 778	\$ 891	\$ 1040	\$ 1200	\$ 1390	\$ 1606
90"	TB-4090WPS	2.75	\$ 474	\$ 723	\$ 837	\$ 961	\$ 1125	\$ 1301	\$ 1510	\$ 1748
96"	TB-4096WPS	3.00	\$ 496	\$ 768	\$ 891	\$ 1027	\$ 1206	\$ 1397	\$ 1626	\$ 1885
102"	TB-40102WPS	3.25	\$ 508	\$ 803	\$ 936	\$ 1084	\$ 1278	\$ 1485	\$ 1732	\$ 2013
108"	TB-40108WPS	3.50	\$ 532	\$ 849	\$ 993	\$ 1151	\$ 1360	\$ 1584	\$ 1850	\$ 2153

NOTE: All tackboards 78" and longer are 2 pieces.

EncompassTM

Casegoods Collection

How to Order

MODEL NO.	DESCRIPTION	
57-3672DP	Finish	AC
	Top Surface	W
	Edge	A
	Pull	BBU

All options must be labeled and specified.



Specifications



veneer

Exposed surfaces feature select grade sliced Cherry, Maple, and American Black Walnut hardwood veneers carefully selected and matched to assure proper balance and consistency.

tops

Wood veneer tops are 5-ply balanced construction and 1 $\frac{1}{32}$ " thick. High pressure laminate tops are 3-ply balanced construction and 1 $\frac{1}{32}$ " thick. Grain direction runs left to right unless noted.

chassis construction

Veneer chassis are fastened by screws, glue, and heavy-duty metal fasteners assuring maximum strength. All units have full modesty panels. Units feature finished backs unless noted. Units ship assembled. All units ship with leveling glides.

drawers

All drawer fronts are 3-ply construction, $\frac{3}{4}$ " thick with matched wood grain. Drawer sides, back and front are wood grain vinyl wrapped, $\frac{1}{2}$ " thick. Box and file drawers have $\frac{1}{8}$ " thick hardboard bottoms. Lateral file drawers feature $\frac{1}{4}$ " thick bottoms. 5-sided drawer construction allows for easy removal of drawer fronts.

drawer suspensions

Box and file drawers have full extension, progressive action slides with precision steel ball bearings. All suspensions have a lifetime warranty.

filing hardware

All file drawers are standard with filing systems designed to accommodate a variety of filing requirements. Letter width file drawers provide letter filing front to back, and letter or legal filing side to side. Lateral file drawers provide legal or letter filing front to back or side to side.

locking

All desks, credenzas, returns, and files feature standard locking. Removable lock cylinders allow for units to be re-keyed at a later date if required. Units ship randomly keyed as standard.

cord management

Route power and data cables away from the worksurface through inherent grommet placement. Black grommets are standard in back panels of assembled returns, bridge units, kneespace credenzas, and hutch units. A grommet is standard in tops of corner units. Grommets may be ordered in the tops of desks, returns, bridge units, credenzas, and component work-surfaces. See page 148 for all optional grommet locations.

Undersurface tracks are available for additional cord management. Silver grommets are also available. See Accessories.

finish

The multi-step finish process used by Indiana Furniture provides years of lasting beauty. High quality finish materials offer distinctive grain clarity, superior resistance to normal wear, and ease of maintenance.

Finish Options

WOOD VENEER (W) OR LAMINATE (P) TOPS – MUST SPECIFY



Light Maple
LM



Mahogany on Walnut
MW

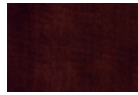

Espresso Walnut
EW



Bourbon Cherry
BC



Dark Cherry
DC



Autumn Cherry
AC



Golden Cherry
GC



Presidential Walnut
PW



Legacy Walnut
LW



Harvest Walnut
HW

Available in High Pressure Laminate Tops. (P)

Edge Options



Waterfall
N



Bevel
B



Radius
A



Flute
X



Square
Y

Pull Options



Aluminum Arc
AAC



Aluminum Orbit
AOR



Aluminum Buckle
ABU



Aluminum Elite
AEL



Aluminum Focus
AFC



Aluminum Bar
ABR



Black Arc
BAC



Black Orbit
BOR



Black Buckle
BBU



Black Elite
BEL



Black Focus
BFC



Black Bar
BBR

COORDINATING PRODUCTS

Encompass Casegoods offers options to coordinate with Aura Conference and Aura Reception.

INTERIOR DRAWER DIMENSIONS

ENCOMPASS 5700 INTERIOR DRAWER DIMENSIONS

Item	Drawers	W	L	D
57-3672BDP	Box	12 1/8	16 3/16	3 1/2
57-3672DP	File	12 1/8	16 3/16	9 5/16
57-3072DP				
57-3066DP				
57-3060DP				
57-3672BLP/BRP				
57-3672LP/RP				
57-3072LP/RP				
57-3066LP/RP				
57-2448LF/RF				
57-2442LF/RF				
57-2072KC				
57-2072SC				
57-2072LC/RC				
57-2066LC/RC/KC/SC				
57-1519MP1				
57-2036L2	File	31 1/2	15 1/16	9 7/32
57-2036L4				
57-2072DL				
57-2072LL/RL				
57-2066LL/RL				
57-2472LMR/RMR	Box	16 3/16	12 1/8	3 1/2
57-2072LMF/RMF	Upper File	12 1/8	16 3/16	9 7/32
57-2066LMF/RMF	Lat File	31 1/2	15 1/16	9 7/32
57-2036MF				
57-1622CD	Center	18 15/16	14 15/16	1 3/4

ENCOMPASS 5900 INTERIOR DRAWER DIMENSIONS

Item	Drawers	W	L	D
59-3672BDP/BDPS	Box	12 1/8	16 3/16	3 1/2
59-3672DP/DPS	File	12 1/8	16 3/16	9 5/16
59-3072DP				
59-3066DP				
59-3060DP				
59-3672BLP/BRP				
59-3672BLPS/BRPS				
59-3672LP/RP				
59-3672LPS/RPS				
59-3072LP/RP				
59-3066LP/RP				
59-2448LF1/RF1				
59-2442LF1/RF1				
59-2072LC1/RC1				
59-2066LC1/RC1				
59-2448LF2/RF2	File	12 1/8	16 3/16	9 5/16
59-2442LF2/RF2				
59-2072KC				
59-2072SC				
59-2072LC2/RC2				
59-2066LC2/RC2/KC/SC				

FILING CAPABILITIES

12 1/8 x 16 3/16

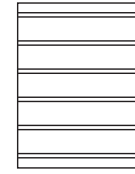

Letter Front to Back

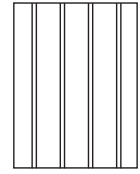

Legal Side to Side

31 1/2 x 15 1/16

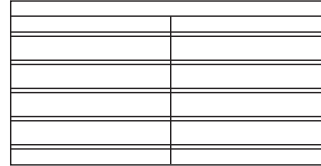

2 Rows Letter or Legal Front to Back

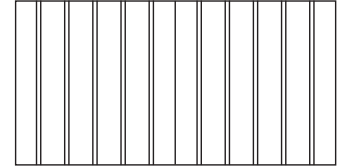

1 Row Letter or Legal Side to Side

GROMMET LOCATIONS

Add upcharge of \$48 list for each grommet.

Specify grommet locations.

- GL - Grommet Left
- GC - Grommet Center
- GR - Grommet Right

Example: 57-3672DP-GL-GR (Grommet Left, Grommet Right)

Grommets may be ordered in non-standard locations. Please call Customer Service to assist with how to order and additional lead time requirements.

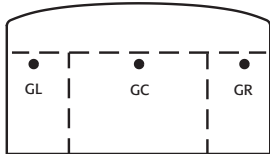

- | | |
|------------|-------------|
| 59-3672BDP | 59-3672BDPS |
| 59-3672BLP | 59-3672BLPS |
| 59-3672BRP | 59-3672BRPS |
| 57-3672BDP | |
| 57-3672BLP | |
| 57-3672BRP | |

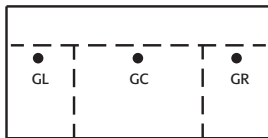
 GL/GR - 6" from ends, 22 1/2" from user side.
 GC - 22 1/2" from user side.

- | | |
|------------|-----------|
| 59-3672DPS | 57-3672DP |
| 59-3672DP | 57-3672LP |
| 59-3672LPS | 57-3672RP |
| 59-3672RPS | |
| 59-3672LP | |
| 59-3672RP | |

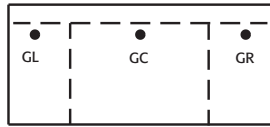
 GL/GR - 6" from ends, 22 1/2" from user side.
 GC - 22 1/2" from user side.

- | | |
|-----------|-----------|
| 59-3072DP | 57-3072DP |
| 59-3066DP | 57-3066DP |
| 59-3072LP | 57-3072LP |
| 59-3072RP | 57-3072RP |
| 59-3066LP | 57-3066LP |
| 59-3066RP | 57-3066RP |

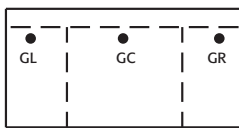
 GL/GR - 6" from ends, 22 1/2" from user side.
 GC - 22 1/2" from user side.

- | |
|-----------|
| 59-3060DP |
| 57-3060DP |

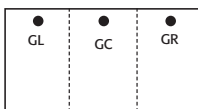
 GL/GR - 6" from ends, 22 1/2" from user side.
 GC - 22 1/2" from user side.

- | | |
|--------------|-----------|
| 59-2448LF2/1 | 57-2448RF |
| 59-2448RF2/1 | 57-2442LF |
| 59-2442LF2/1 | 57-2442RF |
| 59-2442RF2/1 | 57-2448UF |
| 57-2448LF | 57-2442UF |

All 24" Modular Tops, see page 166-167

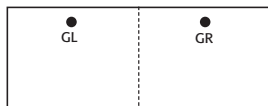
 GL/GR - 6" from ends, 20" from user side.
 GC - 20" from user side.

- | |
|------------|
| 57-2472LMR |
| 57-2472RMR |

GL/GR - 18" from ends, 20" from user side.

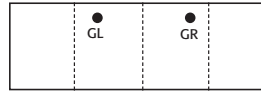
GROMMET LOCATIONS - CONTINUED

- | | |
|--------------|------------|
| 59-2072KC | 57-2072LL |
| 59-2072LC2/1 | 57-2072RL |
| 59-2072RC2/1 | 57-2072RMF |
| 57-2072KC | 57-2072LMF |
| 57-2072LC | |
| 57-2072RC | |

GL/GR - 22 1/2" from ends, 17" from user side.

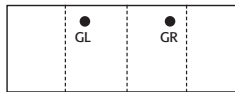

- | | |
|--------------|------------|
| 59-2066KC | 57-2066LL |
| 59-2066LC2/1 | 57-2066RL |
| 59-2066RC2/1 | 57-2066RMF |
| 57-2066KC | 57-2066LMF |
| 57-2066LC | |
| 57-2066RC | |

GL/GR - 19 1/2" from ends, 17" from user side.

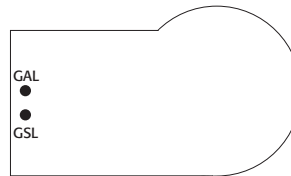

57-4272PR

GAL/GSL - 12" from approach or seated side, 6" from end.

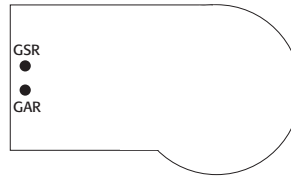

57-4272PL

GSR/GAR - 12" from approach or seated side, 6" from end.



57-3672DUR

GAL/GSL - 12" from approach or seated side, 6" from end.



57-3672DUL

GSR/GAR - 12" from approach or seated side, 6" from end.

LOCKING HUTCH DOORS

Locking doors are available on solid panel hinged doors.

Size	=	List Upcharge
30" - 42"	=	\$58.00
48" - 78"	=	\$71.00
84"	=	\$84.00

Item	Model No.	W	D	H	K	R	Ship Wt	Cubic Ft	List Price
EXECUTIVE DOUBLE FULL PED DESK BOW TOP	59-3672BDPS Stepped Front	72	36-30	30	40 ⁵ / ₁₆	9 ⁷ / ₈	301	52.4	P \$ 3462 W \$ 3493
	59-3672BDP Recessed Front	72	36-30	30	39 ⁹ / ₁₆	9 ⁷ / ₈ - 3 ⁷ / ₈	301	52.4	P \$ 3397 W \$ 3428



Description

- Bow Top
- Locking Pedestals
- Letter Width Pedestals
- Box/Box/File in Left Pedestal
- File/File in Right Pedestal
- Black Utility Tray for Box Drawer

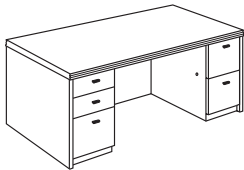
EXECUTIVE DOUBLE FULL PED DESK RECTANGULAR TOP	59-3672DPS Stepped Front	72	36	30	40 ⁵ / ₁₆	9 ⁷ / ₈	302	50.0	P \$ 2973 W \$ 3159
	59-3672DP Recessed Front	72	36	30	39 ⁹ / ₁₆	9 ⁷ / ₈	302	50.0	P \$ 2831 W \$ 3014
	59-3072DP Recessed Front	72	30	30	39 ⁹ / ₁₆	3 ⁷ / ₈	298	43.9	P \$ 2762 W \$ 2937
	59-3066DP Recessed Front	66	30	30	33 ⁹ / ₁₆	3 ⁷ / ₈	274	38.7	P \$ 2665 W \$ 2794
	59-3060DP Recessed Front	60	30	30	27 ⁹ / ₁₆	3 ⁷ / ₈	249	35.3	P \$ 2563 W \$ 2748

Description

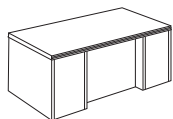
- Rectangular Top
- Locking Pedestals
- Letter Width Pedestals
- Box/Box/File in Left Pedestal
- File/File in Right Pedestal
- Black Utility Tray for Box Drawer



Stepped Front

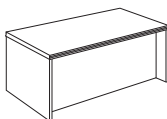

Recessed Front

For ordering options, see back of Encompass Identification card at the beginning of section.

For grommet options, see page 148.

For center drawer options, see page 167.

Item	Model No.	W	D	H	K	R	Ship Wt	Cubic Ft	List Price
EXECUTIVE DOUBLE 3/4 PED DESK BOW TOP	57-3672BDP	72	36-30	30	39 9/16	9 7/8 - 3 7/8	360	52.1	P \$ 3242
	Recessed Front								W \$ 3274

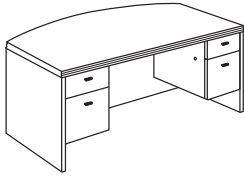
Description

- Bow Top
- Locking Pedestals
- Letter Width Pedestals
- Box/File in Pedestals
- Black Utility Tray for Box Drawer

EXECUTIVE DOUBLE 3/4 PED DESK RECTANGULAR TOP	57-3672DP	72	36	30	39 9/16	9 7/8	375	50.0	P \$ 2603
	Recessed Front								W \$ 2786
	57-3072DP	72	30	30	39 9/16	3 7/8	360	43.9	P \$ 2488
	Recessed Front								W \$ 2663
	57-3066DP	66	30	30	33 9/16	3 7/8	340	38.7	P \$ 2416
	Recessed Front								W \$ 2548
	57-3060DP	60	30	30	27 9/16	3 7/8	235	35.3	P \$ 2327
	Recessed Front								W \$ 2512

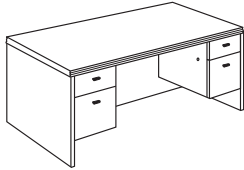
Description

- Rectangular Top
- Locking Pedestals
- Letter Width Pedestals
- Box/File in Pedestals
- Black Utility Tray for Box Drawer

ARC TABLE DESK	57-3672AD	72	36	30	42 3/4	-	220	57.9	P \$ 3193
									W \$ 3294

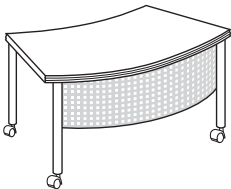
Description

- Perforated Metal Modesty Panel
- 4 Legs with Locking Black Casters
- Overall Floorspace Required is 72" x 42"

Options: Specify & Add

57-CAST-BL	Black Modesty and Legs with Black Casters	Included
57-CAST-AL	Aluminum Modesty and Legs with Black Casters	Included
57-LEG-BL	Black Modesty and Legs with Adjustable Levelers	\$ 126
57-LEG-AL	Aluminum Modesty and Legs with Adjustable Levelers	\$ 126

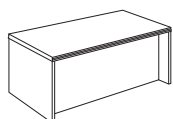

Recessed Front

For ordering options, see back of Encompass Identification card at the beginning of section.

For grommet options, see page 148.

For center drawer options, see page 167.

Item	Model No.	W	D	H	K	R	Ship Wt	Cubic Ft	List Price	
EXECUTIVE SINGLE FULL PED DESK BOW TOP	Left Ped	Right Ped								
	59-3672BLPS Stepped Front	59-3672BRPS	72	36-30	30	32 1/8	-	232	52.1	P \$ 3014 W \$ 3046
	59-3672BLP Recessed Front	59-3672BRP	72	36-30	30	31 3/4	-	231	50.4	P \$ 2938 W \$ 2969

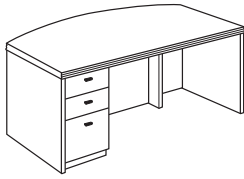
Description

- Bow Top
- Locking Pedestal
- Letter Width Pedestal
- Box/Box/File in Pedestal
- Black Utility Tray for Box Drawer

Item	Model No.	W	D	H	K	R	Ship Wt	Cubic Ft	List Price	
EXECUTIVE SINGLE FULL PED DESK RECTANGULAR TOP	Left Ped	Right Ped								
	59-3672LPS Stepped Front	59-3672RPS	72	36	30	32 1/8	-	259	50.0	P \$ 2380 W \$ 2563
	59-3672LP Recessed Front	59-3672RP	72	36	30	31 3/4	9 7/8	259	50.0	P \$ 2328 W \$ 2512
	59-3072LP Recessed Front	59-3072RP	72	30	30	31 3/4	3 7/8	232	43.9	P \$ 2204 W \$ 2378
	59-3066LP Recessed Front	59-3066RP	66	30	30	25 3/4	3 7/8	211	39.0	P \$ 2097 W \$ 2228

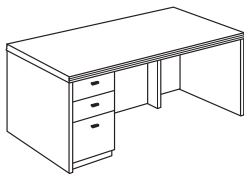

Description

- Rectangular Top
- Locking Pedestal
- Letter Width Pedestal
- Box/Box/File in Pedestal
- Black Utility Tray for Box Drawer

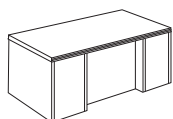
All pedestal desks shown as left.

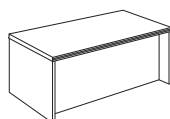

Stepped Front



Recessed Front

For ordering options, see back of Encompass Identification card at the beginning of section.

For grommet options, see page 148.

For center drawer options, see page 167.

Item	Model No.	W	D	H	K	R	Ship Wt	Cubic Ft	List Price
EXECUTIVE SINGLE 3/4 PED DESK BOW TOP	Left Ped	Right Ped							
	57-3672BLP Recessed Front	57-3672BRP	72	36-30	30	31 3/4	9 7/8 - 3 7/8	231	50.4

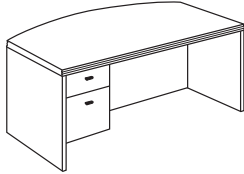
Description

- Bow Top
- Locking Pedestal
- Letter Width Pedestal
- Box/File in Pedestal
- Black Utility Tray for Box Drawer

Item	Model No.	W	D	H	K	R	Ship Wt	Cubic Ft	List Price	
EXECUTIVE SINGLE 3/4 PED DESK RECTANGULAR TOP	Left Ped	Right Ped								
	57-3672LP Recessed Front	57-3672RP	72	36	30	31 3/4	9 7/8	240	50.0	P \$ 2198 W \$ 2380
	57-3072LP Recessed Front	57-3072RP	72	30	30	31 3/4	3 7/8	230	43.9	P \$ 2094 W \$ 2270
	57-3066LP Recessed Front	57-3066RP	66	30	30	25 3/4	3 7/8	211	38.7	P \$ 2022 W \$ 2151

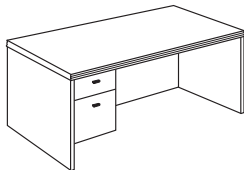
Description

- Rectangular Top
- Locking Pedestal
- Letter Width Pedestal
- Box/File in Pedestal
- Black Utility Tray for Box Drawer

All pedestal desks shown as left.

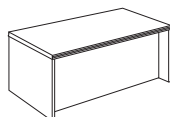

Recessed Front

For ordering options, see back of Encompass Identification card at the beginning of section.

For grommet options, see page 148.

For center drawer options, see page 167.

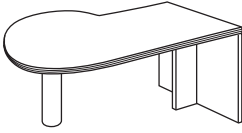
Item	Model No.	W	D	H	K	R	Ship Wt	Cubic Ft	List Price	
P-TOP 	Left Ped									
	Right Ped									
	57-4272PL	72	42-36	30	-	-	164	60.5	P \$ 2893 W \$ 2938	
Description										
<ul style="list-style-type: none"> • End Panel Support • Metal 4 1/2" Cylinder Base. Must Specify: Black or Aluminum. • Not Recommended for Freestanding Applications 										
Options: Specify & Add										
	57-HMD	Optional Half Modesty Panel							\$	162
	57-FMD	Optional Full Modesty Panel							\$	227

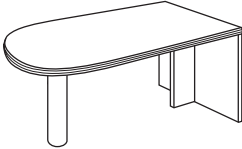
D-TOP	Left Ped	Right Ped	W	D	H	K	R	Ship Wt	Cubic Ft	List Price	
											
	57-3672DUL	57-3672DUR	72	36	30	-	-	155	50.0	P \$ 2132 W \$ 2175	
Description											
<ul style="list-style-type: none"> • End Panel Support • Metal 4 1/2" Cylinder Base. Must Specify: Black or Aluminum. • Not Recommended for Freestanding Applications 											
Options: Specify & Add											
	57-HMD	Optional Half Modesty Panel								\$	162
	57-FMD	Optional Full Modesty Panel								\$	227

All pedestal desks shown as left.

For ordering options, see back of Encompass Identification card at the beginning of section.

For grommet options, see page 148.

For center drawer options, see page 167.

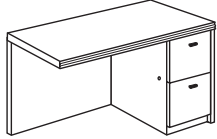
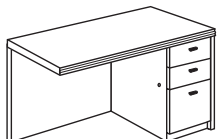
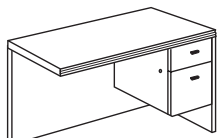
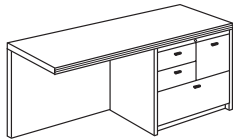
Item	Model No.	W	D	H	K	R	Ship Wt	Cubic Ft	List Price	
EXECUTIVE RETURN FULL PEDESTAL FILE/FILE 	Left Ped	Right Ped								
	59-2448LF2	59-2448RF2	48	24	30	31 3/4	-	144	24.9	P \$ 1641 W \$ 1860
	59-2442LF2	59-2442RF2	42	24	30	25 3/4	-	136	23.3	P \$ 1603 W \$ 1794
	Description <ul style="list-style-type: none"> • Locking Pedestal • Letter Width Pedestal • File/File in Pedestal • Grommet in Back Panel • Grain Direction Runs Front to Back on Worksurface 									
EXECUTIVE RETURN FULL PEDESTAL BOX/BOX/FILE 	Left Ped	Right Ped								
	59-2448LF1	59-2448RF1	48	24	30	31 3/4	-	144	24.9	P \$ 1641 W \$ 1860
	59-2442LF1	59-2442RF1	42	24	30	25 3/4	-	136	23.3	P \$ 1603 W \$ 1794
	Description <ul style="list-style-type: none"> • Locking Pedestal • Letter Width Pedestal • Box/Box/File in Pedestal • Grommet in Back Panel • Grain Direction Runs Front to Back on Worksurface 									
EXECUTIVE RETURN 3/4 PEDESTAL BOX/FILE 	Left Ped	Right Ped								
	57-2448LF	57-2448RF	48	24	30	31 3/4	-	125	24.9	P \$ 1531 W \$ 1755
	57-2442LF	57-2442RF	42	24	30	25 3/4	-	110	20.4	P \$ 1449 W \$ 1642
	Description <ul style="list-style-type: none"> • Locking Pedestal • Letter Width Pedestal • Box/File in Pedestal • Grommet in Back Panel • Grain Direction Runs Front to Back on Worksurface 									
EXECUTIVE RETURN MULTI-FILE PEDESTAL BOX/BOX/FILE/LATERAL 	Left Ped	Right Ped								
	57-2472LMR	57-2472RMR	72	24	30	36	-	263	33.6	P \$ 2519 W \$ 2556
	Description <ul style="list-style-type: none"> • Locking File Drawers Only • Box/Box/File Over Lateral File • Lateral File Provides Legal or Letter Filing Side to Side or Front to Back • Grommet in Back Panel • Grain Direction Runs Front to Back on Veneer Worksurfaces, Laminate Worksurfaces Run Left to Right 									

All returns shown as right.

For ordering options, see back of Encompass Identification card at the beginning of section.

For grommet options, see page 148.

Item	Model No.	W	D	H	K	R	Ship Wt	Cubic Ft	List Price
EXECUTIVE BRIDGE FULL MODESTY	57-2448UF	48	24	30	48	-	81	6.3	P \$ 831 W \$ 879
	57-2442UF	42	24	30	42	-	71	5.3	P \$ 793 W \$ 841

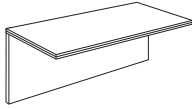
Description

- Grommet in Back Panel
- Grain Direction Runs Front to Back on Worksurface
- Hinged Back Panel

NOTE: Unit ships flat so keyboards will be field installed.

EXECUTIVE BRIDGE HALF MODESTY	57-2448UFH	48	24	11 ⁵ / ₃₂	48	-	61	6.3	P \$ 801 W \$ 849
	57-2442UFH	42	24	11 ⁵ / ₃₂	42	-	51	5.3	P \$ 765 W \$ 813

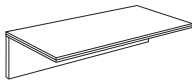
Description

- Grain Direction Runs Front to Back on Worksurface
- Hinged Back Panel

NOTE: Unit ships flat so keyboards will be field installed.

CORNER UNIT	57-4242CU	42	42	30	25 ⁷ / ₁₆	-	145	34.5	P \$ 1671 W \$ 1824
	57-3636CU	36	36	30	17	-	129	27.4	P \$ 1364 W \$ 1518

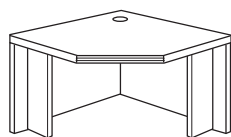
Description

- Freestanding Support Unit
- Connects to 24" Deep Bridge and Return Units
- Grommet in Top
- Grain Direction Runs Front to Back on Worksurface

NOTE: Not all keyboards will fit the 57-3636CU. Recommended keyboards are 1-KCWR, 1-KCPR, and 1-KC.

For ordering options, see back of Encompass Identification card at the beginning of section.

For grommet options, see page 148.

Item	Model No.	W	D	H	K	R	Ship Wt	Cubic Ft	List Price	
EXECUTIVE CREDENZA FULL PEDESTAL FILE/FILE	Left Ped	Right Ped								
	59-2072LC2	59-2072RC2	72	20	30	31 3/4	-	184	30.2	P \$ 1915 W \$ 1962
	59-2066LC2	59-2066RC2	66	20	30	25 3/4	-	172	25.5	P \$ 1839 W \$ 1909

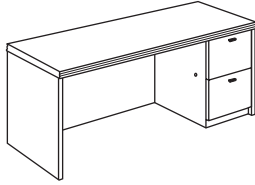
Description

- Locking Pedestal
- Letter Width Pedestal
- File/File in Pedestal
- Grommet in Back Panel

Item	Model No.	W	D	H	K	R	Ship Wt	Cubic Ft	List Price	
EXECUTIVE CREDENZA FULL PEDESTAL BOX/BOX/FILE	Left Ped	Right Ped								
	59-2072LC1	59-2072RC1	72	20	30	31 3/4	-	184	30.2	P \$ 1915 W \$ 1962
	59-2066LC1	59-2066RC1	66	20	30	25 3/4	-	172	25.5	P \$ 1839 W \$ 1909

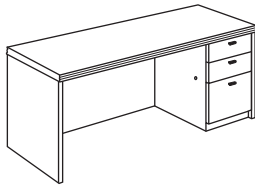
Description

- Locking Pedestal
- Letter Width Pedestal
- Box/Box/File in Pedestal
- Grommet in Back Panel

Item	Model No.	W	D	H	K	R	Ship Wt	Cubic Ft	List Price	
EXECUTIVE CREDENZA 3/4 PEDESTAL BOX/FILE	Left Ped	Right Ped								
	57-2072LC	57-2072RC	72	20	30	31 3/4	-	231	30.2	P \$ 1746 W \$ 1794
	57-2066LC	57-2066RC	66	20	30	25 3/4	-	150	26.6	P \$ 1684 W \$ 1757

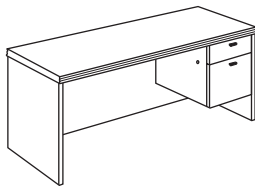
Description

- Locking Pedestal
- Letter Width Pedestal
- Box/File in Pedestal
- Grommet in Back Panel

All credenzas shown as right.

For ordering options, see back of Encompass Identification card at the beginning of section.

For grommet options, see page 148.

Item	Model No.	W	D	H	K	R	Ship Wt	Cubic Ft	List Price	
EXECUTIVE CREDENZA FULL PEDESTAL LATERAL/LATERAL	Left Ped	Right Ped								
	57-2072LL	57-2072RL	72	20	30	12	-	228	29.8	P \$ 2205 W \$ 2250
	57-2066LL	57-2066RL	66	20	30	6	-	211	26.6	P \$ 2097 W \$ 2168

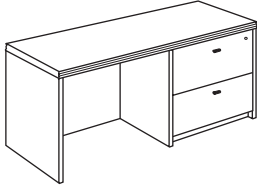
Description

- Central Locking
- Lateral/Lateral in Pedestal
- Provide Legal or Letter Filing Front to Back or Side to Side
- Grommet in Back Panel

Item	Model No.	W	D	H	K	R	Ship Wt	Cubic Ft	List Price	
EXECUTIVE CREDENZA FULL PEDESTAL BOX/BOX/FILE/LATERAL	Left Ped	Right Ped								
	57-2072LMF	57-2072RMF	72	20	30	12	-	228	29.8	P \$ 2626 W \$ 2671
	57-2066LMF	57-2066RMF	66	20	30	6	-	211	26.6	P \$ 2563 W \$ 2634

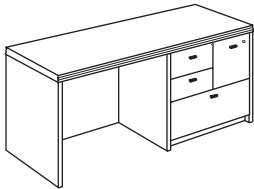
Description

- Locking File Drawers Only
- Box/Box/File/Lateral in Pedestal
- One Lateral File Drawer Provides Legal or Letter Filing Front to Back or Side to Side
- Grommet in Back Panel

All credenzas shown as right.

For ordering options, see back of Encompass Identification card at the beginning of section.

For grommet options, see page 148.

Item	Model No.	W	D	H	K	R	Ship Wt	Cubic Ft	List Price
TRANSACTION RISER FOR DESKS/CREDENZAS	57-1272TR	72	12	13 5/32	-	-	63	9.8	P \$ 1129
	For Use with 72" Worksurfaces								W \$ 1143
	57-1266TR	66	12	13 5/32	-	-	60	9.8	P \$ 1066
	For Use with 66" Worksurfaces								W \$ 1086

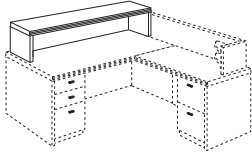
Description

- Freestanding Riser for Desks or Credenzas
- May Be Used in Conjunction with Return Risers or Bridge Risers

Item	Left Ped	Right Ped	W	D	H	K	R	Ship Wt	Cubic Ft	List Price
TRANSACTION RISER FOR RETURNS	57-1270LU	57-1270RU	70	12	12	-	-	40	9.0	W \$ 1129
	For Use with 36" Desks and 48" Returns									
	57-1264LU	57-1264RU	64	12	12	-	-	35	8.2	W \$ 1066
	For Use with 30" Desks and 48" Returns									

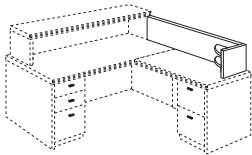
Description

- Must Be Used in Conjunction with a Desk Riser
- Two Storage Shelves

TRANSACTION RISER FOR BRIDGES	57-0978BU	78	9	13 5/32	-	-	47	7.9	P \$ 985
	For Use with 36" Desks, 48" Bridge, and a Credenza								W \$ 1020

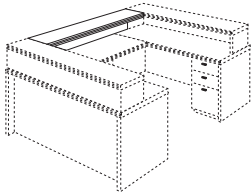
Description

- Must Be Used in Conjunction with Two Desk/Credenza Risers
- Grain Direction Runs Left to Right on Worksurface if Laminate Top is Specified

TRANSACTION RISER FOR BRIDGES	57-1278BP	78	1 5/32	12	-	-	25	3.0	W \$ 578
	For Use with 36" Desk, 48" Bridge, and a Credenza								

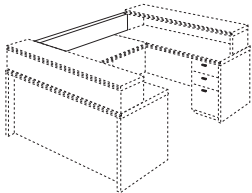
Description

- Must Be Used in Conjunction with Two Desk/Credenza Risers

For ordering options, see back of Encompass Identification card at the beginning of section.

Item	Model No.	W	D	H	K	R	Ship Wt	Cubic Ft	List Price
STORAGE CREDENZA FULL PEDESTAL	59-2072SC	72	20	30	-	-	276	35.0	P \$ 2884 W \$ 2933
	59-2066SC	66	20	30	-	-	255	27.8	P \$ 2602 W \$ 2671

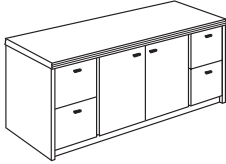
Description

- Pedestals Lock Behind Doors
- Letter Width Pedestals
- File/File in Pedestals
- 12 1/4" Fixed Storage Shelf Behind Doors

STORAGE CREDENZA 3/4 PEDESTAL	57-2072SC	72	20	30	-	-	299	30.2	P \$ 2579 W \$ 2626
	57-2066SC	66	20	30	-	-	285	26.6	P \$ 2296 W \$ 2367

Description

- Locking Pedestals
- Letter Width Pedestals
- Box/File in Pedestals

KNEESPACE CREDENZA FULL PEDESTAL	59-2072KC	72	20	30	39 9/16	-	223	30.2	P \$ 2732 W \$ 2777
	59-2066KC	66	20	30	33 9/16	-	204	26.6	P \$ 2404 W \$ 2474

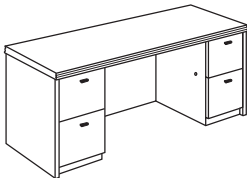
Description

- Locking Pedestals
- Letter Width Pedestals
- File/File in Pedestals
- Grommet in Back Panel

KNEESPACE CREDENZA 3/4 PEDESTAL	57-2072KC	72	20	30	39 9/16	-	207	30.2	P \$ 2361 W \$ 2406
	57-2066KC	66	20	30	33 9/16	-	184	26.6	P \$ 2190 W \$ 2259

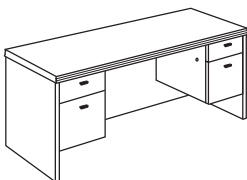
Description

- Locking Pedestals
- Letter Width Pedestals
- Box/File in Pedestals
- Grommet in Back Panel

For ordering options, see back of Encompass Identification card at the beginning of section.

For grommet options, see page 148.

Item	Model No.	W	D	H	K	R	Ship Wt	Cubic Ft	List Price
FOUR DRAWER LATERAL FILE	57-2036L4	36	20	53 7/8	-	-	270	28.3	P \$ 2486 W \$ 2520

Description

- Central Locking
- Anti-Tilt System
- File Drawers Provide Legal or Letter Filing
- 1/4" Thick Drawer Bottoms Allow for Storage Applications
- Unfinished Back

NOTE: Recommended for application against a wall.

TWO DRAWER LATERAL FILE	57-2036L2	36	20	30	-	-	157	15.4	P \$ 1570 W \$ 1605
----------------------------	-----------	----	----	----	---	---	-----	------	------------------------

Description

- Central Locking
- Anti-Tilt System
- File Drawers Provide Legal or Letter Filing
- 1/4" Thick Drawer Bottoms Allow for Storage Applications
- Unfinished Back

NOTE: Recommended for application against a wall.

For ordering options, see back of Encompass Identification card at the beginning of section.

Item	Model No.	W	D	H	K	R	Ship Wt	Cubic Ft	List Price
MULTI-FILE	57-2036MF	36	20	30	-	-	157	15.4	P \$ 1971 W \$ 2002

Description

- Locking File Drawers
- One Lateral File Drawer Provides Legal or Letter Filing
- Upper Section - Box/Box/File
- Lower Section - Lateral File
- Unfinished Back

NOTE: Recommended for application against a wall.

DOUBLE LATERAL CREDENZA	57-2072DL	72	20	30	-	-	314	30.2	P \$ 2885 W \$ 2934
----------------------------	-----------	----	----	----	---	---	-----	------	------------------------

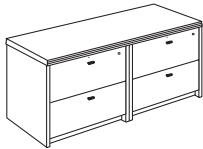
Description

- Dual Locking
- File Drawers Provide Legal or Letter Filing
- 1/4" Thick Drawer Bottoms Allow for Storage Applications
- Unfinished Back

NOTE: Recommended for application against a wall.

MOBILE PEDESTAL	57-1519MP1	15 7/8	19	27 3/4	-	-	85	9.0	W \$ 1009
-----------------	------------	--------	----	--------	---	---	----	-----	-----------

Description

- Locking Pedestal
- Letter Width Pedestal
- Box/Box/File in Pedestal
- Casters Allow for Easy Moving
- Fits Underneath 30" H Worksurfaces
- Finger Pull Not Available

For ordering options, see back of Encompass Identification card at the beginning of section.

Item	Model No.	W	D	H	K	R	Ship Wt	Cubic Ft	List Price
WOOD DOOR SURFACE MOUNT HUTCH	57-1572HU	72	15	42 1/8	-	-	195	36.9	\$ 2132
	57-1566HU	66	15	42 1/8	-	-	166	28.1	\$ 2067

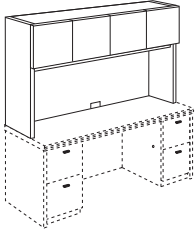
Description

- Storage Behind Wood Doors
- 25" Clearance Below Doors
- Grommet

WOOD FRAMED ACRYLIC DOOR SURFACE MOUNT HUTCH	57-1572AH	72	15	42 1/8	-	-	195	36.9	\$ 2283
	57-1566AH	66	15	42 1/8	-	-	166	28.1	\$ 2221

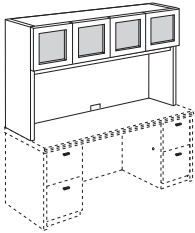

Description

- Storage Behind Acrylic Doors
- 25" Clearance Below Doors
- Grommet

Options: Specify & Add

CA	Clear Acrylic Door Inserts	Included
FA	Frosted Acrylic Door Inserts	Included

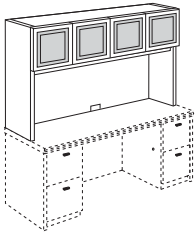
FROSTED ACRYLIC DOOR SURFACE MOUNT HUTCH	57-1572HM	72	15	42 1/8	-	-	195	36.9	\$ 2283
	57-1566HM	66	15	42 1/8	-	-	166	28.1	\$ 2221

Description

- Storage Behind Metallic Framed Acrylic Doors
- 25" Clearance Below Doors
- Grommet

For ordering options, see back of Encompass Identification card at the beginning of section.

For tackboard and tasklights, see page 175.

For additional sizes, see page 176.

Item	Model No.	W	D	H	K	R	Ship Wt	Cubic Ft	List Price
WOOD DOOR SURFACE MOUNT HUTCH	57-1536HU	36	15	42 1/8	-	-	98	17.8	\$ 1794

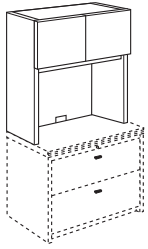
Description

- Storage Behind Wood Doors
- 25" Clearance Below Doors
- Grommet

WOOD FRAMED ACRYLIC DOOR SURFACE MOUNT HUTCH	57-1536AH	36	15	42 1/8	-	-	98	17.8	\$ 1882
--	-----------	----	----	--------	---	---	----	------	---------

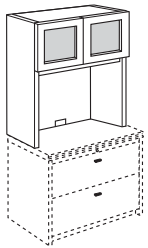

Description

- Storage Behind Acrylic Doors
- 25" Clearance Below Doors
- Grommet

Options: Specify & Add

CA	Clear Acrylic Door Inserts	Included
FA	Frosted Acrylic Door Inserts	Included

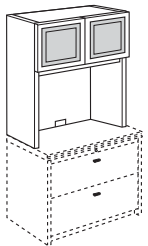
FROSTED ACRYLIC DOOR SURFACE MOUNT HUTCH	57-1536HM	36	15	42 1/8	-	-	98	17.8	\$ 1882
---	-----------	----	----	--------	---	---	----	------	---------



Description

- Storage Behind Metallic Framed Acrylic Doors
- 25" Clearance Below Doors
- Grommet

For ordering options, see back of Encompass Identification card at the beginning of section.

For tackboard and tasklights, see page 175.

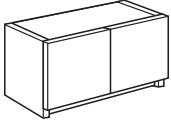
Item	Model No.	W	D	H	K	R	Ship Wt	Cubic Ft	List Price
WOOD DOOR WALL MOUNT HUTCH	57-1536WD Two Door	36	15	17 1/8	-	-	66	7.8	\$ 1519
	57-1530WD Two Door	30	15	17 1/8	-	-	61	7.5	\$ 1410

Description

- Storage Behind Wood Doors
- Mounts to Wall with Mounting Bracket Included

NOTE: Indiana Furniture will not be liable for wall mount hutch units that are not properly installed.

WOOD FRAMED ACRYLIC DOOR WALL MOUNT HUTCH	57-1536AW	36	15	17 1/8	-	-	66	7.8	\$ 1594
	57-1530AW	30	15	17 1/8	-	-	61	7.5	\$ 1488

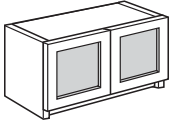
Description

- Storage Behind Acrylic Doors
- Mounts to Wall with Mounting Bracket Included

Options: Specify & Add

CA	Clear Acrylic Door Inserts	Included
FA	Frosted Acrylic Door Inserts	Included

NOTE: Indiana Furniture will not be liable for wall mount hutch units that are not properly installed.

FROSTED ACRYLIC DOOR WALL MOUNT HUTCH	57-1536WM	36	15	17 1/8	-	-	66	7.8	\$ 1594
	57-1530WM	30	15	17 1/8	-	-	61	7.5	\$ 1488

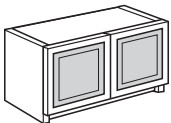
Description

- Storage Behind Metallic Framed Acrylic Doors
- Mounts to Wall with Mounting Bracket Included

NOTE: Indiana Furniture will not be liable for wall mount hutch units that are not properly installed.

For ordering options, see back of Encompass Identification card at the beginning of section.

For tackboard and tasklights, see page 175.

For additional sizes, see page 176.

Item	Model No.	W	D	H	K	R	Ship Wt	Cubic Ft	List Price
TOP UNIT BOOKCASE	57-1536TU	36	15	42 1/8	-	-	85	16.3	W \$ 1060

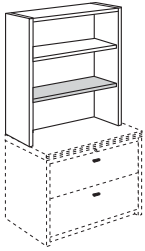
Description

- Fixed Bottom Shelf with 12" Clearance
- One Adjustable Shelf
- For Use on Two Drawer Lateral Files or Credenzas
- 1" Thick Shelves
- Unfinished Back

NOTE: Recommended for application against a wall.

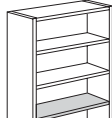
BOOKCASES	Model No.	W	D	H	K	R	Ship Wt	Cubic Ft	List Price
	57-3672BC Three Adjustable Shelves	36	15	71 1/2	-	-	162	26.7	W \$ 1945
	57-3648BC Two Adjustable Shelves - Profiled on Front Edge	36	15	47 1/4	-	-	108	18.7	P \$ 1259 W \$ 1290
	57-3630BC One Adjustable Shelf - Profiled on Front Edge	36	15	30	-	-	68	11.1	P \$ 1122 W \$ 1151

Description

- 1" Thick Shelves
- Unfinished Back

NOTE: Recommended for application against a wall.

1/4 ROUND BOOKCASE	Model No.	W	D	H	K	R	Ship Wt	Cubic Ft	List Price
	57-1472QR Three Adjustable Shelves	14 1/8	14 1/8	71 1/2	-	-	78	9.7	W \$ 1892

Description

- One Fixed Shelf

NOTE: Recommended for application against a wall.

For ordering options, see back of Encompass Identification card at the beginning of section.

Item	Model No.	W	D	H	K	R	Ship Wt	Cubic Ft	List Price
------	-----------	---	---	---	---	---	---------	----------	------------

WARDROBE/STORAGE

Hinged Left	Hinged Right
-------------	--------------

57-1872WL	57-1872WR	18	20	71 1/2	-	-	157	15.4	W \$ 2213
-----------	-----------	----	----	--------	---	---	-----	------	-----------

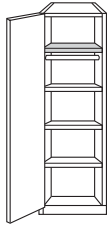

Description

- Fixed Top Shelf
- Coat Rod Under Fixed Shelf
- Three Adjustable Shelves
- Adjustable Shelves can be Removed for Wardrobe Application
- Unfinished Back

NOTE: Recommended for application against a wall.

COMPUTER WORK TABLE

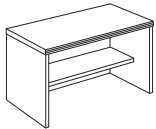
57-2442CW	42	24	27	40	-	-	115	19.2	P \$ 1176
									W \$ 1213

Description

- Fixed Shelf
- Grommet in Back Panel

Options: Specify & Add

CS-57BL	Optional Black Casters								\$ 150
---------	------------------------	--	--	--	--	--	--	--	--------

END TABLE

57-2424ET	24	24	22	-	-	-	33	2.9	P \$ 831
									W \$ 879

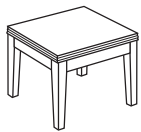
Description

- Hardwood Legs
- Shipped KD

MAGAZINE TABLE

57-2442MT	42	24	16	-	-	-	50	4.6	P \$ 1176
									W \$ 1213

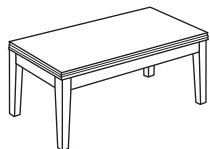
Description

- Hardwood Legs
- Shipped KD

For ordering options, see back of Encompass Identification card at the beginning of section.

Item	Model No.	W	D	H	K	R	Ship Wt	Cubic Ft	List Price
 CIRCULAR TOP	57-4848CT Accommodates 5 Chairs	48	48	1 5/32	-	-	60	5.7	P \$ 1181 W \$ 1488
	57-4242CT Accommodates 4 Chairs	42	42	1 5/32	-	-	48	4.0	P \$ 1066 W \$ 1373
	57-3636CT Accommodates 3 Chairs	36	36	1 5/32	-	-	39	3.4	P \$ 992 W \$ 1297

Description

- One Base Required

 CYLINDER BASE	01-2020CB For Use with 42" or 48" Circular Tops	20	20	28 1/2	-	-	132	12.0	\$ 977
	01-1616CB For Use with 36" Circular Tops	16	16	28 1/2	-	-	100	8.9	\$ 892

Description

- Veneer Cylinder Base
- Weighted for Stability
- 2 Wire Management Grommets Standard at Top with 8" Opening Standard in Bottom

Options: Specify & Add

GCBIS	Optional Grommet Top Edge (1)	\$	N/C
NOGC	Optional No Grommets At Top Edges	\$	N/C

 METAL BASE	01-0400MBB Black	32	32	27 3/4	-	-	32	3.2	\$ 632
	01-0400MBA Aluminum	32	32	27 3/4	-	-	32	3.2	\$ 632

Description

- Shipped KD - Some Assembly Required
- For use with 42" or 36" Circular Top

Open
Market
Only



NOTE: For 48" Top, use 01-0404MB, See Resilience Caseload Series

 CENTER DRAWER	57-1622CD	22	16 7/8	2 3/4	-	-	13	2.2	\$ 309
---	-----------	----	--------	-------	---	---	----	-----	--------

Description

- Fits All Desks, P Top Units, and D Top Units
- Built in Pen Tray

Options: Specify & Add

Factory Installed	\$	130
-------------------	----	-----

SIN 711-8

For ordering options, see back of Encompass Identification card at the beginning of section.

ENCOMPASS™ 5700/5900 SERIES

Modular Components

Item	Model No.	W	D	H	K	R	Ship Wt	Cubic Ft	List Price
 MODULAR CREDENZA TOP	57-2496TP	96	24	1 5/32	-	-	100	4.9	P \$ 827 W \$ 870
	57-2490TP	90	24	1 5/32	-	-	95	4.6	P \$ 817 W \$ 851
	57-2484TP	84	24	1 5/32	-	-	90	4.3	P \$ 804 W \$ 832
	57-2478TP	78	24	1 5/32	-	-	85	4.0	P \$ 794 W \$ 817
	57-2472TP	72	24	1 5/32	-	-	80	3.7	P \$ 717 W \$ 752
	57-2466TP	66	24	1 5/32	-	-	75	3.4	P \$ 701 W \$ 722
	57-2460TP	60	24	1 5/32	-	-	70	3.1	P \$ 683 W \$ 706
	57-2454TP	54	24	1 5/32	-	-	65	2.8	P \$ 641 W \$ 684
	57-2448TP	48	24	1 5/32	-	-	55	2.5	P \$ 626 W \$ 641
	57-2442TP	42	24	1 5/32	-	-	50	2.2	P \$ 613 W \$ 625
	57-2436TP	36	24	1 5/32	-	-	45	1.9	P \$ 581 W \$ 601

Description

- Profiled on User Edge Only
- When Modular Tops have an Open Kneespace of 60" or Greater, a Support Panel is Required, See page 172
- For Table Lifts, See Accessories

MODULAR RETURN TOP	Left Ped	Right Ped	W	D	H	K	R	Ship Wt	Cubic Ft	List Price	
 MODULAR RETURN TOP	57-6024TPL	57-6024TPR	60	24	1 5/32	-	-	70	3.1	P \$ 683 W \$ 706	
	Grain Direction Runs Left to Right on Laminate Top										
	57-5424TPL	57-5424TPR	54	24	1 5/32	-	-	65	2.8	P \$ 641 W \$ 684	
	57-4824TPL	57-4824TPR	48	24	1 5/32	-	-	55	2.5	P \$ 626 W \$ 641	
	57-4224TPL	57-4224TPR	42	24	1 5/32	-	-	50	2.2	P \$ 613 W \$ 625	
	57-3624TPL	57-3624TPR	36	24	1 5/32	-	-	45	1.9	P \$ 581 W \$ 601	

Description

- Profiled on User Side with Reverse Profile on Joining Edge
- Grain Direction Runs Front to Back on the Worksurface Unless Noted Above
- When Modular Tops have an Open Kneespace of 60" or Greater, a Support Panel is Required, See page 172

For ordering options, see back of Encompass Identification card at the beginning of section.

Item	Model No.	W	D	H	K	R	Ship Wt	Cubic Ft	List Price	
MODULAR BRIDGE TOP 	57-6024TPB	60	24	1 5/32	-	-	70	3.1	P \$ 683 W \$ 706	
	Grain Direction Runs Left to Right on Laminate Worksurface									
	57-5424TPB	54	24	1 5/32	-	-	65	2.8	P \$ 641 W \$ 684	
	57-4824TPB	48	24	1 5/32	-	-	55	2.5	P \$ 626 W \$ 641	
	57-4224TPB	42	24	1 5/32	-	-	50	2.2	P \$ 613 W \$ 625	
	57-3624TPB	36	24	1 5/32	-	-	45	1.9	P \$ 581 W \$ 601	

Description

- Profiled on User Side with Reverse Profile on Each End
- Grain Direction Runs Front to Back on the Worksurface Unless Noted Above
- When Modular Tops have an Open Kneespace of 60" or Greater, a Support Panel is Required, See page 172

MODULAR PEDESTAL BOX/BOX/FILE	57-2418PD1	18	23 3/16	28 1/4	-	-	70	9.0	\$ 1013
----------------------------------	------------	----	---------	--------	---	---	----	-----	---------

Description

- Box/Box/File
- Locking
- Legal Width Pedestal
- Open Back
- Modular Top Required

MODULAR PEDESTAL FILE/FILE	57-2418PD2	18	23 3/16	28 1/4	-	-	70	9.0	\$ 1013
-------------------------------	------------	----	---------	--------	---	---	----	-----	---------



Description

- File/File
- Locking
- Legal Width Pedestal
- Open Back
- Modular Top Required

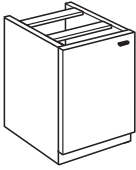
For ordering options, see back of Encompass Identification card at the beginning of section.

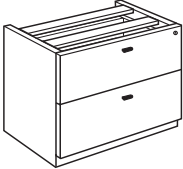
Item	Model No.	W	D	H	K	R	Ship Wt	Cubic Ft	List Price
MODULAR PEDESTAL DOOR BOOKCASE	Hinged Left								
	Hinged Right								
	57-2418PD4L	18	23 ³ / ₁₆	28 ¹ / ₄	-	-	70	9.0	\$ 777
									
Description									
<ul style="list-style-type: none"> • One Adjustable Shelf • Open Back • Modular Top Required 									
Options: Specify & Add									
Optional Locking								\$	43

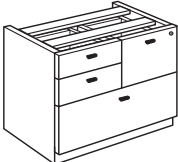
MODULAR PEDESTAL LATERAL FILE	57-2436LF1	36	23 ³ / ₁₆	28 ¹ / ₄	-	-	120	18.5	\$ 1126
									
Description									
<ul style="list-style-type: none"> • Lateral File/Lateral File • Locking • Anti-Tilt System • Open Back • Modular Top Required 									

MODULAR PEDESTAL MULTI-FILE	57-2436LF2	36	23 ³ / ₁₆	28 ¹ / ₄	-	-	120	18.5	\$ 1289
									
Description									
<ul style="list-style-type: none"> • Box/Box/File Over Lateral File • Locking File Drawers Only • Open Back • Modular Top Required 									

For ordering options, see back of Encompass Identification card at the beginning of section.

Item	Model No.	W	D	H	K	R	Ship Wt	Cubic Ft	List Price
MODULAR PEDESTAL DOOR BOOKCASE	57-2436DB	36	23 ³ / ₁₆	28 ¹ / ₄	-	-	120	18.5	\$ 959

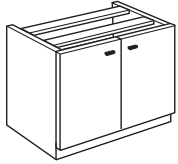

Description

- 13" Adjustable Shelf
- Open Back
- Modular Top Required

Options: Specify & Add

Optional Locking	\$ 43
------------------	-------

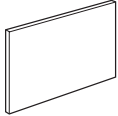
Item	Model No.	W	D	H	K	R	Ship Wt	Cubic Ft	List Price
MODULAR BACK PANEL	57-9628BP	96	³ / ₄	28 ¹ / ₄	-	-	115	5.0	\$ 610
	57-9028BP	90	³ / ₄	28 ¹ / ₄	-	-	108	4.6	\$ 601
	57-8428BP	84	³ / ₄	28 ¹ / ₄	-	-	101	4.3	\$ 593
	57-7828BP	78	³ / ₄	28 ¹ / ₄	-	-	94	4.0	\$ 578
	57-7228BP	72	³ / ₄	28 ¹ / ₄	-	-	86	3.7	\$ 528
	57-6628BP	66	³ / ₄	28 ¹ / ₄	-	-	79	3.4	\$ 510
	57-6028BP	60	³ / ₄	28 ¹ / ₄	-	-	72	3.0	\$ 487
	57-5428BP	54	³ / ₄	28 ¹ / ₄	-	-	65	2.8	\$ 455
	57-4828BP	48	³ / ₄	28 ¹ / ₄	-	-	55	2.5	\$ 432
	57-4228BP	42	³ / ₄	28 ¹ / ₄	-	-	50	2.2	\$ 421
	57-3628BP	36	³ / ₄	28 ¹ / ₄	-	-	45	2.0	\$ 388
	57-3028BP	30	³ / ₄	28 ¹ / ₄	-	-	30	1.6	\$ 377
	57-2428BP	24	³ / ₄	28 ¹ / ₄	-	-	24	1.4	\$ 363
57-1828BP	18	³ / ₄	28 ¹ / ₄	-	-	19	1.0	\$ 350	

Description

- For Use as a Modesty Panel to Create Bridges, Returns, or Credenzas

Options: Specify & Add

1-GRMT Optional Top-Center Grommet	\$ 48
------------------------------------	-------

For ordering options, see back of Encompass Identification card at the beginning of section.

Item	Model No.	W	D	H	K	R	Ship Wt	Cubic Ft	List Price
MODULAR END PANEL	57-2430EP	23 ³ / ₁₆	1 ⁵ / ₃₂	28 ¹ / ₄	-	-	27	1.6	\$ 388

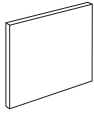
Description

- End Panel for 24" Worksurfaces to Create Returns or Credenzas
- Required to be Used with a Back Panel

MODULAR SUPPORT PANEL	57-2812SP	12	1 ⁵ / ₃₂	28 ¹ / ₄	-	-	12	.8	\$ 322
-----------------------	-----------	----	--------------------------------	--------------------------------	---	---	----	----	--------

Description

- Used to Support Worksurfaces
- Required to be Used Perpendicular to Full Back Panels to Support Kneespace Areas Greater Than 60"

MODULAR T SUPPORT	57-1010SP	10	10	28 ¹ / ₄	-	-	20	.8	\$ 359
-------------------	-----------	----	----	--------------------------------	---	---	----	----	--------

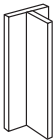
Description

- Used to Support Worksurfaces
- Required to be Used on Kneespace Areas of 60" or Greater Where Back Panels are Not Used

MODULAR FILLER PANEL	57-2803FP	3	³ / ₄	28 ¹ / ₄	-	-	6	.5	\$ 280
----------------------	-----------	---	-----------------------------	--------------------------------	---	---	---	----	--------

Description

- Used to Fill Gap Behind Modular Pedestals When Back Panels are Not Used

For ordering options, see back of Encompass Identification card at the beginning of section.

Item	Model No.	W	D	H	K	R	Ship Wt	Cubic Ft	List Price
EXECUTIVE "L" UNIT	59-1	72	84	30	31	9	403	74.9	P \$ 4021 W \$ 4423

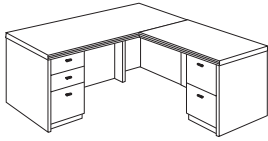
Consists of:
Qty

59-3672LPS	1	• Left Pedestal Desk - Stepped Front	P \$ 2380 W \$ 2563
59-2448RF2	1	• Executive Right Return	P \$ 1641 W \$ 1860

EXECUTIVE "U" UNIT BOW TOP DESK STEPPED FRONT	59-2	72	104	30	31	9-3	676	121.3	P \$ 7892 W \$ 8019
---	------	----	-----	----	----	-----	-----	-------	------------------------

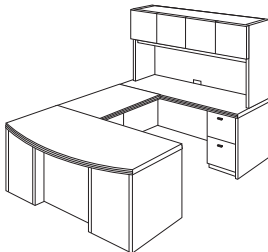
Consists of:
Qty

59-3672BLPS	1	• Bow Left Pedestal Desk	P \$ 3014 W \$ 3046
57-2448UF	1	• Bridge	P \$ 831 W \$ 879
59-2072RC2	1	• Executive Single Right Credenza	P \$ 1915 W \$ 1962
57-1572HU	1	• Hutch	W \$ 2132

All pedestal desks shown as left.
 All returns/credenzas shown as right.

For ordering options, see back of Encompass Identification card at the beginning of section.

For standard options, see page 148.

Item	Model No.	W	D	H	K	R	Ship Wt	Cubic Ft	List Price
EXECUTIVE "U" UNIT P-TOP	59-3	72	110	30	-	-	429	97.0	P \$ 7771 W \$ 7911

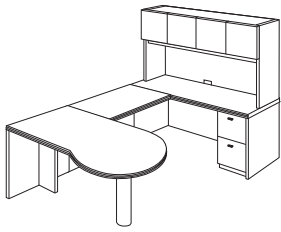

Consists of:	Qty		
57-4272PL	1	• Left P Top Unit	P \$ 2893 W \$ 2938
57-2448UF	1	• Bridge	P \$ 831 W \$ 879
59-2072RC2	1	• Executive Single Right Credenza	P \$ 1915 W \$ 1962
57-1572HU	1	• Hutch	W \$ 2132

EXECUTIVE "U" UNIT D-TOP	59-4	72	104	30	-	-	420	86.5	P \$ 4878 W \$ 5016
-----------------------------	------	----	-----	----	---	---	-----	------	------------------------

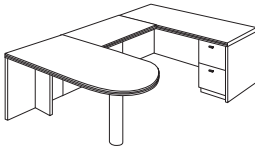

Consists of:	Qty		
57-3672DUL	1	• Peninsula D Top Unit	P \$ 2132 W \$ 2175
57-2448UF	1	• Bridge	P \$ 831 W \$ 879
59-2072RC2	1	• Executive Single Right Credenza	P \$ 1915 W \$ 1962

U units shown as right layouts.

For ordering options, see back of Encompass Identification card at the beginning of section.

For standard options, see page 148.

TACKBOARD: SURFACE MOUNTED HUTCHES – 23 7/8" TALL

Size	Model #	COM ydg	COM, Grade 1, 2 or 3 List Price	Grade 4 List Price	Grade 5 List Price	Grade 6 List Price	Grade 7 List Price	Grade 8 List Price	Grade 9 List Price	Grade 10 List Price
36"	TB-5736H	1.25	\$ 242	\$ 355	\$ 406	\$ 463	\$ 538	\$ 617	\$ 713	\$ 821
66"	TB-5766H	2.00	\$ 336	\$ 518	\$ 600	\$ 690	\$ 810	\$ 937	\$ 1090	\$ 1263
72"	TB-5772H	2.25	\$ 357	\$ 561	\$ 653	\$ 755	\$ 890	\$ 1033	\$ 1204	\$ 1399
78"	TB-5778H	2.50	\$ 397	\$ 624	\$ 726	\$ 840	\$ 989	\$ 1148	\$ 1339	\$ 1555
84"	TB-5784H	2.50	\$ 404	\$ 631	\$ 734	\$ 847	\$ 996	\$ 1156	\$ 1346	\$ 1562

NOTE: All tackboards 78" and longer are 2 pieces.

TACKBOARD: WALL MOUNTED HUTCHES – 21 7/8" TALL

Size	Model #	COM ydg	COM, Grade 1, 2 or 3 List Price	Grade 4 List Price	Grade 5 List Price	Grade 6 List Price	Grade 7 List Price	Grade 8 List Price	Grade 9 List Price	Grade 10 List Price
30"	TB-0130W	1.00	\$ 247	\$ 338	\$ 379	\$ 424	\$ 484	\$ 547	\$ 624	\$ 710
36"	TB-0136W	1.25	\$ 274	\$ 387	\$ 438	\$ 495	\$ 570	\$ 649	\$ 744	\$ 853
42"	TB-5742W	1.25	\$ 281	\$ 394	\$ 446	\$ 502	\$ 577	\$ 657	\$ 752	\$ 860
48"	TB-5748W	1.50	\$ 311	\$ 447	\$ 508	\$ 576	\$ 666	\$ 761	\$ 876	\$ 1005
54"	TB-5754W	1.75	\$ 340	\$ 498	\$ 570	\$ 649	\$ 754	\$ 865	\$ 999	\$ 1150
60"	TB-5760W	2.00	\$ 357	\$ 538	\$ 620	\$ 711	\$ 830	\$ 958	\$ 1110	\$ 1283
66"	TB-5766W	2.00	\$ 383	\$ 564	\$ 646	\$ 737	\$ 856	\$ 984	\$ 1136	\$ 1309
72"	TB-5772W	2.25	\$ 405	\$ 609	\$ 702	\$ 804	\$ 938	\$ 1081	\$ 1253	\$ 1447
78"	TB-5778W	2.50	\$ 439	\$ 666	\$ 769	\$ 882	\$ 1031	\$ 1191	\$ 1381	\$ 1597
84"	TB-5784W	2.50	\$ 449	\$ 675	\$ 778	\$ 891	\$ 1040	\$ 1200	\$ 1390	\$ 1606

NOTE: All tackboards 78" and longer are 2 pieces.

TASKLIGHTS – Includes 1 Wire Management Grommet

Model #	Size	Description	List Price
TL-0824	22 1/2" x 1 5/8" x 7/8"	84-LED, 7 Watts	\$ 234
TL-0848	47 1/2" x 1 5/8" x 7/8"	240-LED, 18 Watts	\$ 280

Item	Model No.	W	D	H	K	R	Ship Wt	Cubic Ft	List Price
WOOD DOOR SURFACE MOUNT HUTCH	57-1584HU Five Door	84	15	42 1/8	-	-	235	36.9	\$ 2647
	57-1578HU Four Door	78	15	42 1/8	-	-	195	30.7	\$ 2402

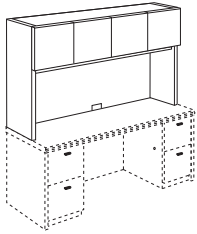
Description

- Storage Behind Wood Doors
- 25" Clearance Below Doors
- Grommet
- Optional Locking Available on Solid Panel Doors and Wood Framed Doors, See Page 148

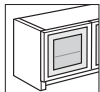
Options: Specify & Add

1-AD	Metallic Framed Frosted Acrylic Doors	\$75 per Door
------	---------------------------------------	---------------

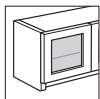

1-WFA	Wood Framed Frosted Acrylic Doors	\$75 per Door
-------	-----------------------------------	---------------

1-WCA	Wood Framed Clear Acrylic Doors	\$75 per Door
-------	---------------------------------	---------------

Item	Model No.	W	D	H	K	R	Ship Wt	Cubic Ft	List Price
WOOD DOOR WALL MOUNT HUTCH	57-1584WD Five Door	84	15	17 1/8	-	-	217	32.7	\$ 2427
	57-1578WD Four Door	78	15	17 1/8	-	-	201	28.3	\$ 2107
	57-1572WD Four Door	72	15	17 1/8	-	-	185	23.9	\$ 2075
	57-1566WD Four Door	66	15	17 1/8	-	-	170	22.0	\$ 2011
	57-1560WD Four Door	60	15	17 1/8	-	-	155	20.1	\$ 1975
	57-1554WD Three Door	54	15	17 1/8	-	-	140	18.1	\$ 1839
	57-1548WD Three Door	48	15	17 1/8	-	-	124	16.2	\$ 1758
	57-1542WD Two Door	42	15	17 1/8	-	-	109	12.3	\$ 1671

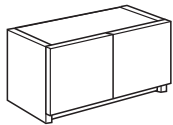
Description

- Storage Behind Wood Doors
- Mounts to Wall with Mounting Bracket Included
- Optional Locking Available on Solid Panel Doors and Wood Framed Doors, See Page 148

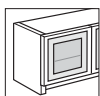
Options: Specify & Add

1-AD	Metallic Framed Frosted Acrylic Doors	\$75 per Door
------	---------------------------------------	---------------

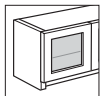

1-WFA	Wood Framed Frosted Acrylic Doors	\$75 per Door
-------	-----------------------------------	---------------

1-WCA	Wood Framed Clear Acrylic Doors	\$75 per Door
-------	---------------------------------	---------------

NOTE: Indiana Furniture will not be liable for wall mount hutch units that are not properly installed.

All wood framed doors lock on two and four door hutches. On three door and five door hutches the third door does not lock.

Gesso®

Casegoods Collection

How to Order

MODEL NO.	DESCRIPTION
67-3672DP	Finish AW
	Top Surface W
	Profile F
	Pull AAC

All options must be labeled and specified.



Specifications

VENEER

Exposed surfaces feature select grade sliced hardwood veneers in Cherry, Maple, American Black Walnut, or composite veneers of Walnut and Wenge. Veneers are carefully selected and matched to assure proper balance and consistency.

TOPS

Veneer and high pressure laminate tops are 3-ply balanced construction and 1-3/16" thick, with 3 mm wood edge-banded rims contoured to the selected profile. Tops are shaped on user and approach sides. Grain direction runs left to right unless otherwise noted in the item description.

CHASSIS CONSTRUCTION

Chassis is securely fastened using high quality European fastening systems and heavy-duty, 16-gauge joining brackets to assure maximum strength. Units ship assembled unless otherwise noted. All units ship with heavy-duty, adjustable leveling glides to ensure proper leveling and compensation for uneven floors.

DRAWERS

All drawer fronts are 3-ply construction 3/4" thick, with vertically matched grain in sets. Drawer sides, back, and front are wood grain vinyl wrapped, 1/2" thick. Box and file drawers have 1/8" thick hardboard bottoms. Lateral file drawers feature 1/4" thick bottoms for maximum storage strength. 5-sided drawer construction allows for easy removal of drawer fronts.

DRAWER SUSPENSION

Box and file drawers have full extension, progressive action slides with precision steel ball bearings. All suspensions have a lifetime warranty.

FILING HARDWARE

All file drawers are standard with filing systems designed to accommodate a variety of filing requirements. Letter width file drawers provide letter filing front to back, and letter or legal filing side to side. Lateral file drawers provide legal or letter filing front to back or side to side.

LOCKING

All desks, credenzas, returns, and files feature standard locking. Removable lock cylinders allow for units to be re-keyed at a later date if required. Units ship randomly keyed. Lock cores match pull color.

CORD MANAGEMENT

Route power and data cables away from the worksurface through inherent grommet placement. Grommets may be ordered in the tops of all assembled desks, returns, bridges, credenzas, and component worksurfaces. All desks, returns, and credenzas (except lateral pedestals) have standard wire openings from inside the pedestal to the kneespace allowing quick access to technology below. Additionally, returns, bridge units, kneespace credenzas, and hutch units have standard grommets available in backpanels. Grommets are also standard in the tops of corner units and extended corner units. See page 183 for all optional grommet locations.

Undersurface tracks are available for additional cord management. Silver grommets are also available. See Accessories.

FINISH

Gesso features Ultra-Violet matte finish on all exposed surfaces by utilizing roll-coat UV technology. Our durable UVAdvantage® finish makes surfaces less likely to be damaged by abrasions, scratches, water, alcohol, stains, and common chemicals. Our UVAdvantage® finish magnifies the beauty of our wood finishes and reduces the darkening, aging, and yellowing process of wood furniture that naturally occurs over time. Once cured by UV lighting, our UVAdvantage® finish does not emit irritable toxins, formaldehyde, or solvents into the air creating a safe work environment within new furniture installations. This process has allowed us to achieve third party certification for Indoor Air Quality. Additionally our UVAdvantage® finish greatly reduces hazardous air pollutants which contribute to smog formation, and our UVAdvantage® finish is recaptured over and over again reducing waste materials. Automated production technology eliminates exposure to sprayed chemicals in our factories. High gloss UVAdvantage® finish available on request.



Stylish Form

Finish Options

WOOD VENEER (W) LAMINATE (P) TOPS - MUST SPECIFY

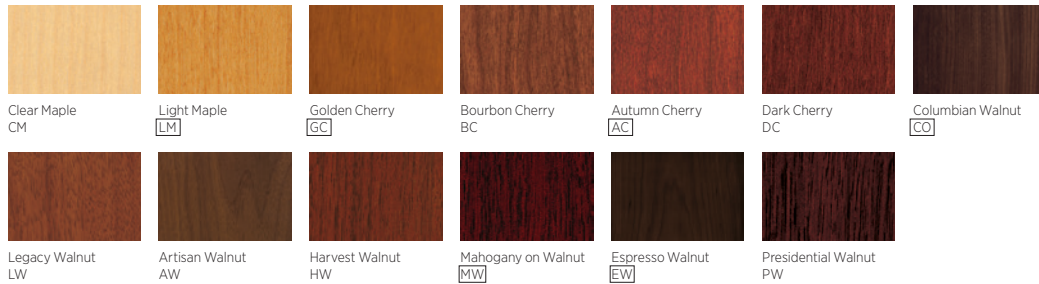

Available in High Pressure Laminate Tops on veneer chassis. (P)

COMPOSITE VENEER (CV)

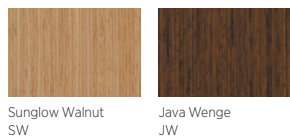

METAL FRAME OPTIONS

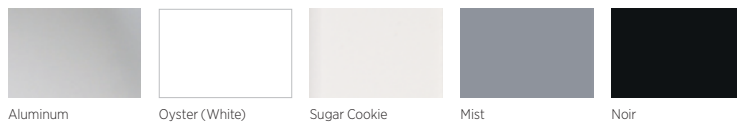

Edge Options

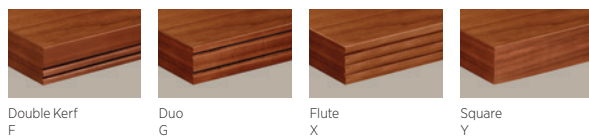

Pull Options



COORDINATING PRODUCTS

Gesso Casegoods offers options to coordinate with Etch Conference and Aura Reception.

INTERIOR DRAWER DIMENSIONS

GESSO 6700 INTERIOR DRAWER DIMENSIONS

Item	Drawers	W	L	D
67-4872CBLP/CBRP	Box	12 1/8	16 3/16	3 1/2
67-4272CLP/CRP	File	12 1/8	16 3/16	9 5/16
67-3672LPS/RPS				
67-3672LP/RP				
67-3672DPS				
67-3672BLPS/BRPS				
67-3672BLP/BRP				
67-3672BDPS				
67-3072LP/RP				
67-3072DP				
67-3066DP				
67-3060DP				
67-4824RF2/LF2	File	12 1/8	16 3/16	9 5/16
67-4224RF2/LF2				
67-2472SC				
67-2472RC2/LC2				
67-2472KC				
67-2466SC				
67-2466RC2/LC2				
67-2466KC				
67-2448RF2/LF2				
67-2442RF2/LF2				
67-4824RF1/LF1	Box	12 1/8	16 3/16	3 1/2
67-4224RF1/LF1	File	12 1/8	16 3/16	9 5/16
67-2472RC1/LC1				
67-2466RC1/LC1				
67-2448RF1/LF1				
67-2442RF1/LF1				

GESSO 6500 INTERIOR DRAWER DIMENSIONS

Item	Drawers	W	L	D
65-3672LP/RP	Box	12 1/8	16 3/16	3 1/2
65-3672DP	File	12 1/8	16 3/16	9 5/16
65-3672BLP/BRP				
65-3672BDP				
65-3072DP				
65-3066DP				
65-3060DP				
65-2415SHPD2				
65-2515SHPD1				
65-2472SC				
65-2472RC/LC				
65-2472KC				
65-2466SC				
65-2466RC/LC				
65-2466KC				
65-2448RF/LF				
65-2442RF/LF				
65-2415PD1				
65-1519MP				

INTERIOR DRAWER DIMENSIONS

GESSO 6500 INTERIOR DRAWER DIMENSIONS

Item	Drawers	W	L	D
65-3672WDS2	Lat File	26 9/32	15 1/16	9 7/32
65-3072SU2				
65-2430LF1				
65-3672SU2	Lat File	32 9/32	15 1/16	9 7/32
65-2436LF1				
65-2418LTF	Tray	14 9/32	15 1/8	1 3/4
	File	14 9/32	15 1/8	9 5/16
65-2430LTF	Tray	26 9/32	15 1/16	1 21/32
	Lat File	26 9/32	15 1/16	9 7/32
65-2436LTF	Tray	32 9/32	15 1/16	1 21/32
	Lat File	32 9/32	15 1/16	9 7/32
65-2436OMF	Box	14 9/32	15 1/8	3 1/2
	Lat File	32 9/32	15 1/16	9 7/32
65-2430OMF	Box	11 3/4	16 3/16	3 1/2
	Lat File	26 9/32	15 1/16	9 7/32
65-2472BF	Box	32 1/8	16 3/16	3 1/2
65-2472RMR/LMR	Box	14 9/32	15 1/8	3 1/2
65-2472RMF/LMF	File	14 9/32	15 1/8	9 5/16
65-2436MF	Lat File	32 9/32	15 1/16	9 7/32
65-2436LF2	Box	14 9/32	15 1/8	3 1/2
	File	14 9/32	15 1/8	9 1/4
	Lat File	32 9/32	15 1/16	9 1/4
65-2430LF2	Box	11 23/32	16 3/16	3 1/2
	File	11 23/32	16 3/16	9 1/4
	Lat File	26 9/32	15 1/16	9 1/4
65-2418PD2	File	14 9/32	15 1/8	9 5/16
65-1872WFO				
65-1872WFL/WFR				
65-1872DS2L/DS2R				
65-2418PD1	Box	14 9/32	15 1/8	3 1/2
65-1872WBO	File	14 9/32	15 1/8	9 5/16
65-1872WBL/WBR				
65-1872DS1L/DS1R				
65-2415PD2	File	12 1/8	16 3/16	9 5/16
65-2430L4	Lat File	25 17/32	15 1/16	9 7/32
65-2430L2				
65-2472RL/LL	Lat File	31 1/2	15 1/16	9 7/32
65-2472DL				
65-2436L4				
65-2436L2				
65-1622CD	Center	18 15/16	14 15/16	1 3/4

FILING CAPABILITIES

11 ²³/₃₂ x 16 ³/₁₆

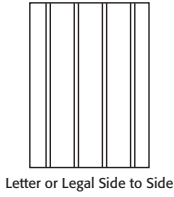

12 ¹/₈ x 16 ³/₁₆

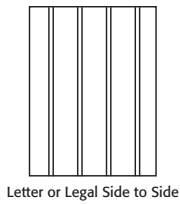

14 ⁹/₃₂ x 15 ¹/₈

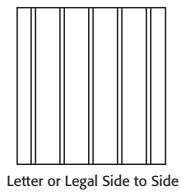
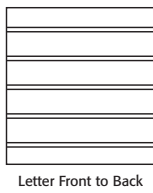

25 ¹⁷/₃₂ x 15 ¹/₁₆

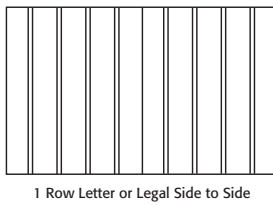
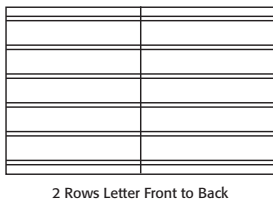

FILING CAPABILITIES

26 ⁹/₃₂ x 15 ¹/₁₆

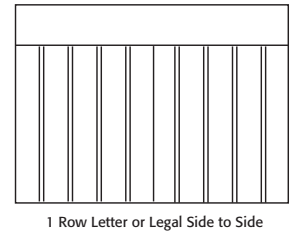
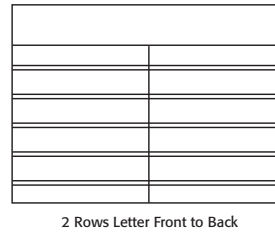

31 ¹/₂ x 15 ¹/₁₆

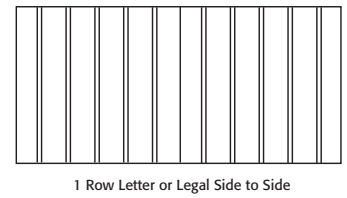
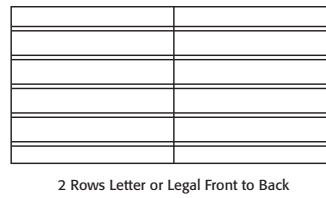

32 ⁹/₃₂ x 15 ¹/₁₆

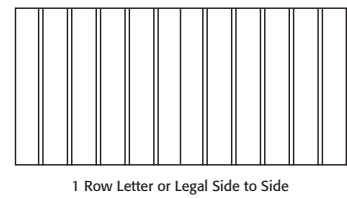
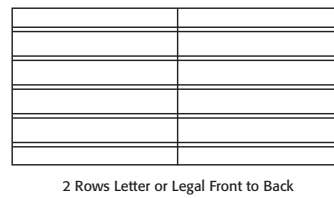

GROMMET LOCATIONS

Grommets are standard in the back panels of returns, bridges, and credenzas. These units may be ordered without grommets at no additional charge. Please specify "NO GROMMET" on order.

Grommets are available on hutches in standard locations for task-light management at no additional charge. Please specify HUGRMT.

Desk grommets are available in standard locations. Please specify and add an upcharge of \$48 list for each grommet.

Specify grommet locations.

- GL - Grommet Left
- GC - Grommet Center
- GR - Grommet Right

Example: 65-3672DP-GL-GR (Grommet Left, Grommet Right)

Grommets may be ordered in non-standard locations. Please call Customer Service to assist with how to order and additional lead time requirements.

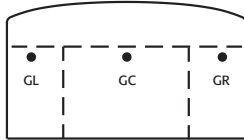

- | | |
|------------------|----------------|
| 67-4872CBLP/CBRP | 65-3672BDP |
| 67-3672BDPS | 65-3672BLP/BRP |
| 67-3672BLPS/BRPS | |
| 67-3672BDPS | |
| 67-3672BLP/BRP | |

GL/GR - 6" from ends, 22 1/2" from user side.

GC - 22 1/2" from user side.

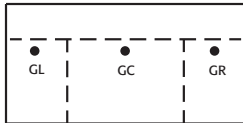

- | | |
|----------------|--------------|
| 67-4272CLP/CRP | 65-3672DP |
| 67-3672DPS | 65-3672LP/RP |
| 67-3672LPS/RPS | 65-3672SH |
| 67-3672LP/RP | |
| 65-3672TP | |

GL/GR - 6" from ends, 22 1/2" from user side.

GC - 22 1/2" from user side.

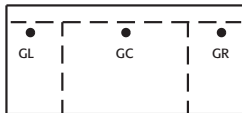

- | | |
|--------------|--------------|
| 67-3072DP | 65-3072DP |
| 67-3066DP | 65-3066DP |
| 67-3060DP | 65-3060DP |
| 67-3072LP/RP | 65-3072LP/RP |
| 67-3066LP/RP | 65-3066LP/RP |
| | 65-3072TP |
| | 65-3066TP |
| | 65-3060TP |

GL/GR - 6" from ends, 22 1/2" from user side.

GC - 22 1/2" from user side.

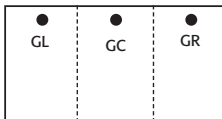

- | | |
|----------------|---------------|
| 67-2448LF1/RF1 | 65-2448LF/RF |
| 67-2448LF2/RF2 | 65-2442LF/RF |
| 67-2442LF1/RF1 | 65-2448UF/UFH |
| 67-2442LF2/RF2 | 65-2442UF/UFH |

GL/GR - 6" from ends, 20" from user side.

GC - 20" from user side.



- | |
|----------------|
| 65-2472LMR/RMR |
| 65-2472LL/RL |
| 65-2472RMF/LMF |
| 65-2466LL/RL |
| 65-2466RMF/LMF |

GL/GR - 6" from ends, 20" from user side.

GROMMET LOCATIONS - CONTINUED

- | | |
|----------------|----------------|
| 67-2472KC | 67-2466KC |
| 67-2472LC1/RC1 | 67-2466LC1/RC1 |
| 67-2472LC2/RC2 | 67-2466LC2/RC2 |
| 65-2472KC | 65-2466KC |
| 65-2472LC/RC | 65-2466LC/RC |
| 65-2472SH | |

All 24" Modular Tops, See Page 223

GL/GR - 6" from ends, 20" from user side.

GC - 20" from user side.



- | |
|-----------|
| 65-4284PR |
| 65-4284TR |
| 65-4272PR |
| 65-4272TR |



- | |
|-----------|
| 65-4284PL |
| 65-4284TL |
| 65-4272PL |
| 65-4272TL |

GAL/GSL - 12" from approach or seated side, 6" from end.

GAR/GSR - 12" from approach or seated side, 6" from end.



- | |
|------------|
| 65-4272EDR |
|------------|



- | |
|------------|
| 65-4272EDL |
|------------|

GAL/GAR - 12" from approach, 6" from end.

GSL/GSR - 24" from approach, 6" from end.



- | |
|------------|
| 65-3684DUR |
| 65-3672DUR |
| 65-3072DUR |
| 65-3066DUR |



- | |
|------------|
| 65-3684DUL |
| 65-3672DUL |
| 65-3684DR |
| 65-3672DR |
| 65-3072DUL |
| 65-3066DUL |
| 65-3066DR |

GAL/GSL - 12" from approach or seated side, 6" from end.

GAR/GSR - 12" from approach or seated side, 6" from end.

LOCKING HUTCH DOORS

Locking doors are available on standard veneer doors and wood framed doors that are hinged.

Size	=	List Upcharge
30" - 42"	=	\$58.00
48" - 78"	=	\$71.00
84" - 108"	=	\$84.00

Sit-To-Stand Mechanisms

Electric powered sit-to-stand mechanisms are offered on select units as noted. Sit-to-stand mechanisms come factory installed and must be specified at the time of order.

Please note, optional modesty panels and kneespace options are not available with the sit-to-stand mechanism.

2 year warranty. Add 100 lbs. to shipping weight.

Description

- Maximum height is 42"
- Load capacity is recommended at a safe 50 lbs; weight distribution is key to capacity
- Safety stop at 2" above the work surface prevents pinches
- Sit-to-stand mechanisms reduce the kneespace depth by 9.5"
- Bridge, returns and credenzas will not have a standard grommet on back panel

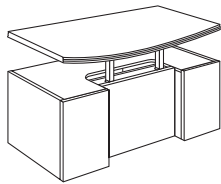

Sit-to-Stand

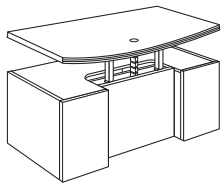

Sit-to-Stand w/Vertebrae

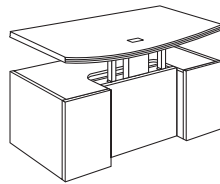

Sit-to-Stand w/Box

Specify & Add

STS Sit-To-Stand	\$ 4095
------------------	---------

Options:

01-BLUETOOTHSWITCH	Blue-Tooth	\$ 52
01-MEMORYSWITCH	Programmable Control	\$ 86

Wire Management and Data

- One data or wire management location per unit
- Order the port and specify the location from chart below
- Grommet not an option without Vertebrae or Box

Locations	Grommet w/Vertebrae \$182 List	Grommet w/Box \$439 List	DPORT4 w/Box \$1109 List	Duo Bezel w/Box \$884 List	Trio Bezel w/Box \$916 List
≥66" Desks/Credenzas	Left/Right/Center	Center	Center	Center	Center
60" Desks	Left/Right/Center	-	-	-	-
Returns	Over Ped/Center	-	-	-	-
Bridges	Center	Center	Center	Center	Center

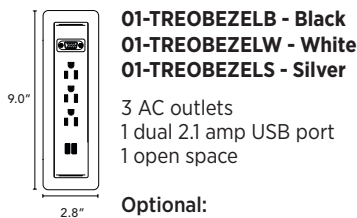
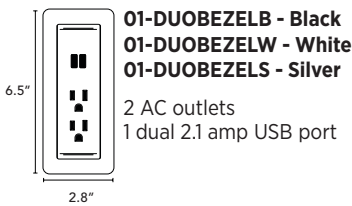

Optional:
 01-LCOMVGA \$77
 01-LCOMHDMI \$104
 01-LCOMRJ45 \$49

NOTE: 01-LCOMHDMI Is Open Market Only



01-DPORT4B - Black
01-DPORT4A - Aluminum

2 AC outlets
2 open ports

Optional:
 01-USBPORT \$102
 01-VOICE1 \$46
 01-RJ4DATA \$105

Item	Model No.	W	D	H	K	R	Ship Wt	Cubic Ft	List Price
EXECUTIVE DOUBLE PED DESK BOW TOP	67-3672BDPS	72	36-30	30	40 1/2	-	410	50.0	\$ 3710 CV\$ 4265

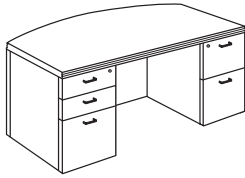
Description

- Bow Top
- Stepped Front
- Letter Width Locking Pedestals
- Full Modesty Standard Available in Optional Colors
- Box/Box/File in Left Pedestal; File/File in Right Pedestal
- Wire Management from Pedestal to Kneespace
- Black Utility Tray for Box Drawer
- Sit-to-Stand Option Available, See Page 184

Options: Specify & Add

65-TMD	Optional Veneer 3/4 Modesty Panel	Included
--------	-----------------------------------	----------

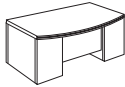

65-TWF	Optional Wood Framed Acrylic 3/4 Modesty Panel	\$ 206
--------	--	--------

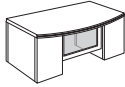

NOTE: Not Available in Composite Veneer

65-TSC	Optional Silver Framed Acrylic 3/4 Modesty Panel	\$ 330
--------	--	--------

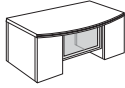

EXECUTIVE DOUBLE PED DESK RECTANGULAR TOP	67-3672DPS	72	36	30	40 1/2	-	425	50.0	\$ 3653 CV\$ 4201
--	------------	----	----	----	--------	---	-----	------	----------------------

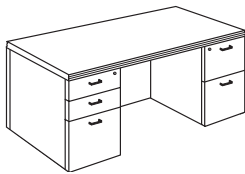
Description

- Stepped Front
- Letter Width Locking Pedestals
- Full Modesty Standard Available in Optional Colors
- Box/Box/File in Left Pedestal; File/File in Right Pedestal
- Wire Management from Pedestal to Kneespace
- Black Utility Tray for Box Drawer
- Sit-to-Stand Option Available, See Page 184

Options: Specify & Add

65-TMD	Optional Veneer 3/4 Modesty Panel	Included
--------	-----------------------------------	----------

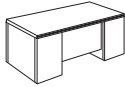

65-TWF	Optional Wood Framed Acrylic 3/4 Modesty Panel	\$ 206
--------	--	--------

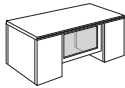

NOTE: Not Available in Composite Veneer

65-TSC	Optional Silver Framed Acrylic 3/4 Modesty Panel	\$ 330
--------	--	--------

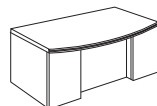
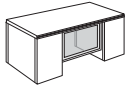

Stepped Front

For ordering options, see back of Gesso Identification card at the beginning of the section.

For grommet options, see page 183.

For center drawer options, see page 221.

Item	Model No.	W	D	H	K	R	Ship Wt	Cubic Ft	List Price
EXECUTIVE DOUBLE PED DESK BOW TOP	67-3672BDP	72	36-30	30	40 1/2	9-3	410	50.0	\$ 3560 CV\$ 4093

Description

- Bow Top
- Recessed Front
- Letter Width Locking Pedestals
- Box/Box/File in Left Pedestal
- File/File in Right Pedestal
- Wire Management from Pedestal to Kneespace
- Black Utility Tray for Box Drawer
- Sit-to-Stand Option Available, See Page 184

EXECUTIVE DOUBLE PED DESK RECTANGULAR TOP	67-3672DP	72	36	30	40 1/2	9	425	50.0	\$ 3106 CV\$ 3570
	67-3072DP	72	30	30	40 1/2	3	410	43.9	\$ 3000 CV\$ 3449
	67-3066DP	66	30	30	34 1/2	3	390	38.7	\$ 2891 CV\$ 3326
	67-3060DP	60	30	30	28 1/2	3	358	35.3	\$ 2763 CV\$ 3178

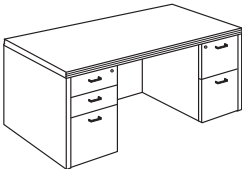
Description

- Recessed Front
- Letter Width Locking Pedestals
- Box/Box/File in Left Pedestal
- File/File in Right Pedestal
- Wire Management from Pedestal to Kneespace
- Black Utility Tray for Box Drawer
- Sit-to-Stand Option Available, See Page 184



Recessed Front

For ordering options, see back of Gesso Identification card at the beginning of the section.

For grommet options, see page 183.

For center drawer options, see page 221.

Item	Model No.	W	D	H	K	R	Ship Wt	Cubic Ft	List Price
EXECUTIVE DOUBLE 3/4 PED DESK BOW TOP	65-3672BDP	72	36-30	30	40 1/2	9-3	360	50.0	\$ 3265 CV\$ 3754



Description

- Bow Top
- Recessed Front
- Letter Width Locking Pedestals
- Box/File in Pedestals
- Wire Management from Pedestal to Kneespace
- Black Utility Tray for Box Drawer

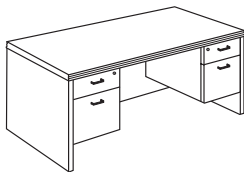
EXECUTIVE DOUBLE 3/4 PED DESK RECTANGULAR TOP	65-3672DP	72	36	30	40 1/2	9	375	50.0	\$ 2773 CV\$ 3188
	65-3072DP	72	30	30	40 1/2	3	360	43.9	\$ 2624 CV\$ 3018
	65-3066DP	66	30	30	34 1/2	3	340	38.7	\$ 2563 CV\$ 2948
	65-3060DP	60	30	30	28 1/2	3	308	35.3	\$ 2484 CV\$ 2857

Description

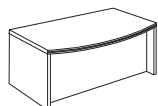
- Recessed Front
- Letter Width Locking Pedestals
- Box/File in Pedestals
- Wire Management from Pedestal to Kneespace
- Black Utility Tray for Box Drawer



Recessed Front

For ordering options, see back of Gesso Identification card at the beginning of the section.

For grommet options, see page 183.

For center drawer options, see page 221.

Item	Model No.	W	D	H	K	R	Ship Wt	Cubic Ft	List Price	
EXECUTIVE SINGLE FULL PED DESK BOW TOP	Left Ped									
	Right Ped									
	67-3672BLPS	67-3672BRPS	72	36-30	30	32 1/4	9-3	320	50.0	\$ 3330
										CV\$ 3829

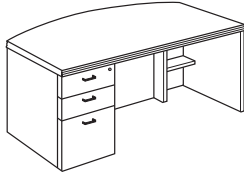
Description

- Bow Top
- Stepped Front
- Letter Width Locking Pedestal
- Full Modesty Standard Available in Optional Colors
- Box/Box/File in Pedestal
- Wire Management from Pedestal to Kneespace
- Black Utility Tray for Box Drawer
- Sit-to-Stand Option Available, See Page 184

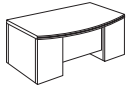
Options: Specify & Add

65-TMD	Optional Veneer 3/4 Modesty Panel	Included
--------	-----------------------------------	----------

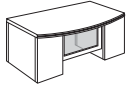

65-TWF	Optional Wood Framed Acrylic 3/4 Modesty Panel	\$ 206
--------	--	--------

NOTE: Not Available in Composite Veneer

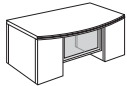

65-TSC	Optional Silver Framed Acrylic 3/4 Modesty Panel	\$ 330
--------	--	--------

Item	Model No.	W	D	H	K	R	Ship Wt	Cubic Ft	List Price	
EXECUTIVE SINGLE FULL PED DESK RECTANGULAR TOP	Left Ped									
	Right Ped									
	67-3672LPS	67-3672RPS	72	36	30	32 1/4	-	330	50.0	\$ 2886
										CV\$ 3317

Description

- Stepped Front
- Letter Width Locking Pedestal
- Full Modesty Standard Available in Optional Colors
- Box/Box/File in Pedestal
- Wire Management from Pedestal to Kneespace
- Black Utility Tray for Box Drawer
- Sit-to-Stand Option Available, See Page 184

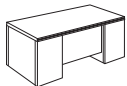
Options: Specify & Add

65-TMD	Optional Veneer 3/4 Modesty Panel	Included
--------	-----------------------------------	----------

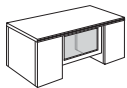

65-TWF	Optional Wood Framed Acrylic 3/4 Modesty Panel	\$ 206
--------	--	--------

NOTE: Not Available in Composite Veneer

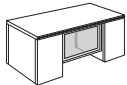

65-TSC	Optional Silver Framed Acrylic 3/4 Modesty Panel	\$ 330
--------	--	--------

All pedestal desks shown as left.

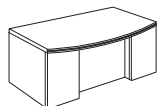

Stepped Front

For ordering options, see back of Gesso Identification card at the beginning of the section.

For grommet options, see page 183.

For center drawer options, see page 221.

Item	Model No.	W	D	H	K	R	Ship Wt	Cubic Ft	List Price	
EXECUTIVE SINGLE FULL PED DESK BOW TOP	Left Ped									
	Right Ped									
	67-3672BLP	67-3672BRP	72	36-30	30	32 1/4	9-3	320	50.0	\$ 3137
										CV\$ 3610

Description

- Bow Top
- Recessed Front
- Letter Width Locking Pedestal
- Box/Box/File in Pedestal
- Wire Management from Pedestal to Kneespace
- Black Utility Tray for Box Drawer
- Sit-to-Stand Option Available, See Page 184

EXECUTIVE SINGLE FULL PED DESK RECTANGULAR TOP	Left Ped	Right Ped								
	67-3672LP	67-3672RP	72	36	30	32 1/4	9	330	50.0	\$ 2640
										CV\$ 3035
	67-3072LP	67-3072RP	72	30	30	32 1/4	3	210	43.0	\$ 2600
										CV\$ 2992
	67-3066LP	67-3066RP	66	30	30	26 1/4	3	160	38.7	\$ 2493
										CV\$ 2867

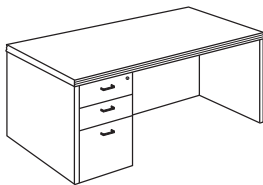
Description

- Recessed Front
- Letter Width Locking Pedestal
- Box/Box/File in Pedestal
- Wire Management from Pedestal to Kneespace
- Black Utility Tray for Box Drawer
- Sit-to-Stand Option Available, See Page 184

All pedestal desks shown as left.



Recessed Front

For ordering options, see back of Gesso Identification card at the beginning of the section.

For grommet options, see page 183.

For center drawer options, see page 221.

Item	Model No.	W	D	H	K	R	Ship Wt	Cubic Ft	List Price
EXECUTIVE SINGLE 3/4 PED DESK BOW TOP	Left Ped								
	Right Ped								
	65-3672BLP	72	36-30	30	32 1/4	9-3	305	50.0	\$ 2779
									CV\$ 3195

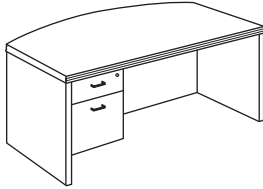
Description

- Bow Top
- Recessed Front
- Letter Width Locking Pedestal
- Box/File in Pedestal
- Wire Management from Pedestal to Kneespace
- Black Utility Tray for Box Drawer

EXECUTIVE SINGLE 3/4 PED DESK RECTANGULAR TOP	Left Ped	Right Ped	W	D	H	K	R	Ship Wt	Cubic Ft	List Price
		65-3672LP	65-3672RP	72	36	30	32 1/4	9	305	50.0
										CV\$ 2656
	65-3072LP	65-3072RP	72	30	30	32 1/4	3	180	43.0	\$ 2226
										CV\$ 2560
	65-3066LP	65-3066RP	66	30	30	26 1/4	3	150	38.7	\$ 2065
										CV\$ 2376

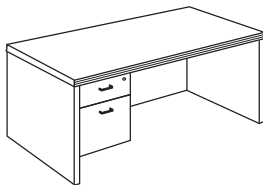
Description

- Recessed Front
- Rectangular Top
- Letter Width Locking Pedestal
- Box/File in Pedestal
- Wire Management from Pedestal to Kneespace
- Black Utility Tray for Box Drawer

All pedestal desks shown as left.



Recessed Front

For ordering options, see back of Gesso Identification card at the beginning of the section.

For grommet options, see page 183.

For center drawer options, see page 221.

Item	Model No.	W	D	H	K	R	Ship Wt	Cubic Ft	List Price	
EXECUTIVE CURVED SINGLE FULL PED DESK BOW TOP	Left Ped									
	Right Ped									
	67-4872CBLP	67-4872CBRP	72	48-30	30	-	-	365	68.5	\$ 3567
										CV\$ 4101

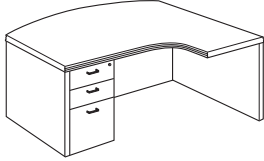

Description

- Bow Top
- Recessed Front
- Letter Width Locking Pedestal
- Box/Box/File in Pedestal
- Wire Management from Pedestal to Kneespace
- Black Utility Tray for Box Drawer

Item	Model No.	W	D	H	K	R	Ship Wt	Cubic Ft	List Price	
EXECUTIVE CURVED SINGLE FULL PED DESK RECTANGULAR TOP	Left Ped									
	Right Ped									
	67-4272CLP	67-4272CRP	72	42-30	30	-	-	350	65.8	\$ 3379
										CV\$ 3887

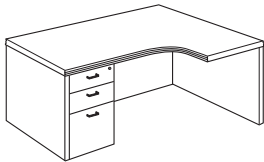

Description

- Rectangular Top
- Recessed Front
- Letter Width Locking Pedestal
- Box/Box/File in Pedestal
- Wire Management from Pedestal to Kneespace
- Black Utility Tray for Box Drawer

All pedestal desks shown as left.



Recessed Front

For ordering options, see back of Gesso Identification card at the beginning of the section.

For grommet options, see page 183.

For center drawer options, see page 221.

Item	Model No.	W	D	H	K	R	Ship Wt	Cubic Ft	List Price	
P-TOP CYLINDER BASE	Left Top	Right Top								
	65-4284PL	65-4284PR	84	42-36	30	-	-	161	59.8	\$ 2981 CV\$ 3428
	65-4272PL	65-4272PR	72	42-36	30	-	-	161	59.8	\$ 2733 CV\$ 3143

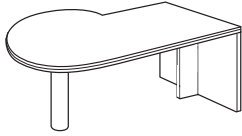
Description

- End Panel Support
- Metal Cylinder Base - 4 1/2" Diameter. Must Specify: Black or Aluminum.
- Not Recommended for Freestanding Applications

Options: Specify & Add

		84"	72"
65-HMD	Optional Half Modesty Panel	\$ 202	\$ 180
65-FMD	Optional Full Modesty Panel	\$ 239	\$ 215
65-HWF	Optional Wood Framed Acrylic Half Modesty Panel NOTE: Not Available in Composite Veneer	\$ 347	\$ 313
65-HSC	Optional Metallic Framed Acrylic Half Modesty Panel	\$ 365	\$ 327

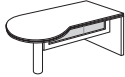

D-TOP CYLINDER BASE	Left Top	Right Top								
	65-3684DUL	65-3684DUR	84	36	30	-	-	187	60.5	\$ 2676 CV\$ 3079
	65-3672DUL	65-3672DUR	72	36	30	-	-	160	50.0	\$ 2278 CV\$ 2620
	65-3084DUL	65-3084DUR	84	30	30	-	-	190	51.0	\$ 2595 CV\$ 2985
	65-3072DUL	65-3072DUR	72	30	30	-	-	160	44.0	\$ 2208 CV\$ 2540
	65-3066DUL	65-3066DUR	66	30	30	-	-	146	40.0	\$ 2109 CV\$ 2426

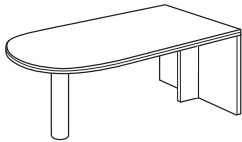
Description

- End Panel Support
- Metal Cylinder Base - 4 1/2" Diameter. Must Specify: Black or Aluminum.
- Not Recommended for Freestanding Applications

Options: Specify & Add

		84"	72"	66"
65-HMD	Optional Half Modesty Panel	\$ 202	\$ 180	\$ 163
65-FMD	Optional Full Modesty Panel	\$ 239	\$ 215	\$ 192
65-HWF	Optional Wood Framed Acrylic Half Modesty Panel NOTE: Not Available in Composite Veneer	\$ 347	\$ 313	\$ 282
65-HSC	Optional Metallic Framed Acrylic Half Modesty Panel	\$ 365	\$ 327	\$ 291

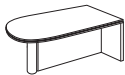

For ordering options, see back of Gesso Identification card at the beginning of the section.

For grommet options, see page 183.

Item	Model No.	W	D	H	K	R	Ship Wt	Cubic Ft	List Price	
EXTENDED D-TOP CYLINDER BASE	Left Top									
	Right Top									
	65-4272EDL	65-4272EDR	72	42-30	30	-	-	163	58.0	\$ 2301 CV\$ 2646

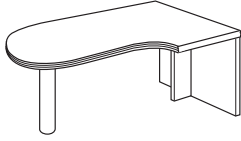

Description

- End Panel Support
- Metal Cylinder Base - 4 1/2" Diameter. Must Specify: Black or Aluminum.
- Not Recommended for Freestanding Applications

Option: Specify & Add

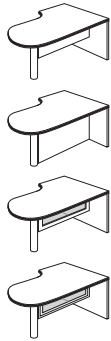

65-HMD	Optional Half Modesty Panel	\$	180
65-FMD	Optional Full Modesty Panel	\$	215
65-HWF	Optional Wood Framed Acrylic Half Modesty Panel	\$	313
NOTE: Not Available in Composite Veneer			
65-HSC	Optional Metallic Framed Acrylic Half Modesty Panel	\$	327

For ordering options, see back of Gesso Identification card at the beginning of the section.

For grommet options, see page 183.

Item	Model No.	W	D	H	K	R	Ship Wt	Cubic Ft	List Price	
EXECUTIVE FULL PEDESTAL RETURN FILE/FILE	Left Ped	Right Ped								
	67-2448LF2	67-2448RF2	48	24	30	32 1/4	-	151	23.1	\$ 1716
										CV\$ 1975
	67-2442LF2	67-2442RF2	42	24	30	26 1/4	-	133	20.4	\$ 1643
										CV\$ 1890

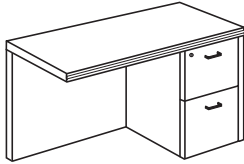
Description

- Letter Width Locking Pedestal
- File/File in Pedestal
- Wire Management from Pedestal to Kneespace
- Optional Grommet Standard in Back Panel
- Grain Direction Runs Front to Back on Worksurface
- Sit-to-Stand Option Available, See Page 184

Item	Model No.	W	D	H	K	R	Ship Wt	Cubic Ft	List Price	
EXECUTIVE FULL PEDESTAL RETURN BOX/BOX/FILE	Left Ped	Right Ped								
	67-2448LF1	67-2448RF1	48	24	30	32 1/4	-	151	23.1	\$ 1716
										CV\$ 1975
	67-2442LF1	67-2442RF1	42	24	30	26 1/4	-	133	20.4	\$ 1643
										CV\$ 1890

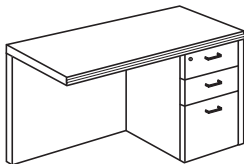
Description

- Letter Width Locking Pedestal
- Box/Box/File in Pedestal
- Wire Management from Pedestal to Kneespace
- Optional Grommet Standard in Back Panel
- Grain Direction Runs Front to Back on Worksurface
- Sit-to-Stand Option Available, See Page 184

Item	Model No.	W	D	H	K	R	Ship Wt	Cubic Ft	List Price	
EXECUTIVE 3/4 PEDESTAL RETURN BOX/FILE	Left Ped	Right Ped								
	65-2448LF	65-2448RF	48	24	30	32 1/4	-	125	23.1	\$ 1586
										CV\$ 1824
	65-2442LF	65-2442RF	42	24	30	26 1/4	-	110	20.4	\$ 1432
										CV\$ 1647

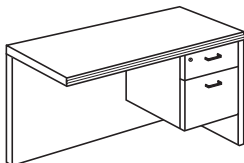
Description

- Letter Width Locking Pedestal
- Box/File in Pedestal
- Wire Management from Pedestal to Kneespace
- Optional Grommet Standard in Back Panel
- Grain Direction Runs Front to Back on Worksurface

All returns shown as right.

For ordering options, see back of Gesso Identification card at the beginning of the section.

For grommet options, see page 183.

For center drawer options, see page 221.

Item	Model No.	W	D	H	K	R	Ship Wt	Cubic Ft	List Price	
EXECUTIVE MULT-FILE RETURN BOX/BOX/FILE/LATERAL	Left Ped									
	Right Ped									
	65-2472LMR	65-2472RMR	72	24	30	36	-	280	33.6	\$ 3252
										CV\$ 3739

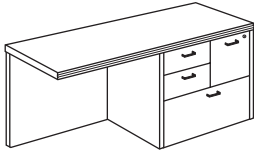
Description

- Locking File Drawers Only
- Box/Box/File/Lateral in Pedestal
- Optional Grommet Standard in Back Panel
- Grain Direction Runs Front to Back on Veneer Worksurfaces;
Laminate Worksurfaces Run Left to Right

EXTENDED FULL PEDESTAL RETURN FILE/FILE	Left Ped	Right Ped	W	D	H	K	R	Ship Wt	Cubic Ft	List Price
	Model No.	Model No.								
	67-4824LF2	67-4824RF2	48	24	30	32 1/4	-	151	23.1	\$ 1716
										CV\$ 1975
	67-4224LF2	67-4224RF2	42	24	30	26 1/4	-	133	20.4	\$ 1643
										CV\$ 1890

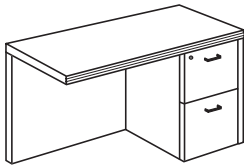
Description

- Letter Width Locking Pedestal
- File/File in Pedestal
- Wire Management from Pedestal to Kneespace
- Optional Grommet Standard in Back Panel
- Grain Direction Runs Left to Right on Worksurface
- For Use with Extended Corner Units and Standard Corner Units
- Sit-to-Stand Option Available, See Page 184

EXTENDED FULL PEDESTAL RETURN BOX/BOX/FILE	Left Ped	Right Ped	W	D	H	K	R	Ship Wt	Cubic Ft	List Price
	Model No.	Model No.								
	67-4824LF1	67-4824RF1	48	24	30	32 1/4	-	151	23.1	\$ 1716
										CV\$ 1975
	67-4224LF1	67-4224RF1	42	24	30	26 1/4	-	133	20.4	\$ 1643
										CV\$ 1890

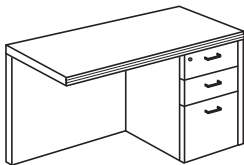
Description

- Letter Width Locking Pedestal
- Box/Box/File in Pedestal
- Wire Management from Pedestal to Kneespace
- Optional Grommet Standard in Back Panel
- Grain Direction Runs Left to Right on Worksurface
- For Use with Extended Corner Units
- Sit-to-Stand Option Available, See Page 184

All returns shown as right.

For ordering options, see back of Gesso Identification card at the beginning of the section.

For grommet options, see page 183.

For center drawer options, see page 221.

Item	Model No.	W	D	H	K	R	Ship Wt	Cubic Ft	List Price
EXECUTIVE BRIDGE FULL MODESTY	65-2448UF	48	24	30	48	-	82	5.3	\$ 783
									CV\$ 901
	65-2442UF	42	24	30	42	-	68	4.7	\$ 753
									CV\$ 866

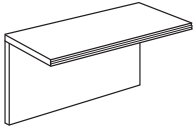
Description

- Optional Grommet Standard in Back Panel
- Grain Direction Runs Front to Back on Worksurface
- Hinged Back Panel
- Sit-to-Stand Option Available, See Page 184

NOTE: Keyboards can not be factory installed.

EXECUTIVE BRIDGE HALF MODESTY	65-2448UFH	48	24	11 ³ / ₁₆	48	-	78	5.3	\$ 739
									CV\$ 866
	65-2442UFH	42	24	11 ³ / ₁₆	42	-	74	4.6	\$ 707
									CV\$ 814

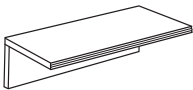

Description

- Grain Direction Runs Front to Back on Worksurface
- Hinged Back Panel

NOTE: Keyboards can not be factory installed.

For ordering options, see back of Gesso Identification card at the beginning of the section.

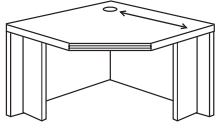
Item	Model No.	W	D	H	K	R	Ship Wt	Cubic Ft	List Price
CORNER UNIT	65-4242CU	42	42	30	25 7/16	-	145	34.5	\$ 1670 CV\$ 1922
	65-3636CU	36	36	30	17	-	109	26.3	\$ 1391 CV\$ 1599

Description

- Freestanding Support Unit
- Connects to 24" Deep Worksurfaces
- Grommet in Top
- Grain Direction Runs as Shown on Worksurface

NOTE: Not all keyboards will fit the 65-3636CU. Recommended keyboards are 1-KCWR, 1-KCPR, and 1-KC.

Item	Model No.	W	D	H	K	R	Ship Wt	Cubic Ft	List Price
CURVED CORNER UNIT	65-4242CCU	42	42	30	25 7/16	-	145	34.5	\$ 2068 CV\$ 2380
	65-3636CCU	36	36	30	17	-	109	26.3	\$ 1789 CV\$ 2057

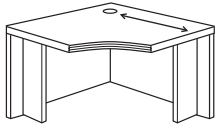
Description

- Freestanding Support Unit
- Connects to 24" Deep Worksurfaces
- Grommet in Top
- Grain Direction Runs as Shown on Worksurface

NOTE: Not all keyboards will fit the 65-3636CCU. Recommended keyboards are 1-KCWR, 1-KCPR, and 1-KC.

Item	Left Unit	Right Unit	W	D	H	K	R	Ship Wt	Cubic Ft	List Price
EXTENDED CORNER UNIT	65-4854ECCL	65-4854ECCR	48	54	30	-	-	174	41.1	\$ 2562 CV\$ 2947

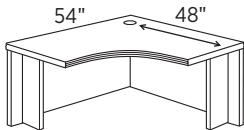

Shown as Right

Description

- Grain Direction Runs as Shown on Worksurface

For ordering options, see back of Gesso Identification card at the beginning of the section.

For grommet options, see page 183.

Item	Model No.	W	D	H	K	R	Ship Wt	Cubic Ft	List Price	
EXECUTIVE FULL PEDESTAL CREDENZA FILE/FILE	Left Ped	Right Ped								
	67-2472LC2	67-2472RC2	72	24	30	32 1/4	-	199	35.6	\$ 2160
										CV\$ 2483
	67-2466LC2	67-2466RC2	66	24	30	26 1/4	-	182	32.7	\$ 2138
									CV\$ 2457	

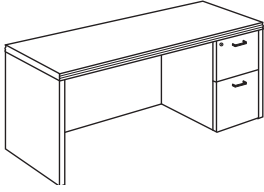
Description

- Letter Width Locking Pedestal
- File/File in Pedestal
- Wire Management from Pedestal to Kneespace
- Optional Grommet Standard in Back Panel
- Sit-to-Stand Option Available, See Page 184

Item	Model No.	W	D	H	K	R	Ship Wt	Cubic Ft	List Price	
EXECUTIVE FULL PEDESTAL CREDENZA BOX/BOX/FILE	Left Ped	Right Ped								
	67-2472LC1	67-2472RC1	72	24	30	32 1/4	-	199	35.6	\$ 2160
										CV\$ 2483
	67-2466LC1	67-2466RC1	66	24	30	26 1/4	-	182	32.7	\$ 2138
									CV\$ 2457	

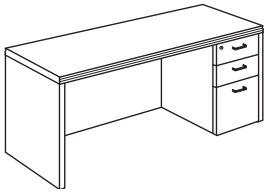
Description

- Letter Width Locking Pedestal
- Box/Box/File in Pedestal
- Wire Management from Pedestal to Kneespace
- Optional Grommet Standard in Back Panel
- Sit-to-Stand Option Available, See Page 184

Item	Model No.	W	D	H	K	R	Ship Wt	Cubic Ft	List Price	
EXECUTIVE 3/4 PEDESTAL CREDENZA BOX/FILE	Left Ped	Right Ped								
	65-2472LC	65-2472RC	72	24	30	32 1/4	-	242	35.6	\$ 1943
										CV\$ 2233
	65-2466LC	65-2466RC	66	24	30	26 1/4	-	170	32.7	\$ 1895
									CV\$ 2179	

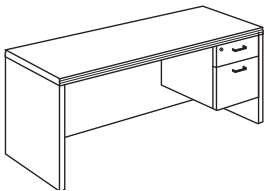
Description

- Letter Width Locking Pedestal
- Box/File in Pedestal
- Wire Management from Pedestal to Kneespace
- Optional Grommet Standard in Back Panel

All credenzas shown as right.

For ordering options, see back of Gesso Identification card at the beginning of the section.

For grommet options, see page 183.

Item	Model No.	W	D	H	K	R	Ship Wt	Cubic Ft	List Price	
EXECUTIVE FULL PEDESTAL CREDENZA LATERAL/LATERAL	Left Ped	Right Ped								
	65-2472LL	65-2472RL	72	24	30	12	-	277	35.6	\$ 2839
										CV\$ 3265
	65-2466LL	65-2466RL	66	24	30	6	-	264	32.7	\$ 2800
										CV\$ 3220

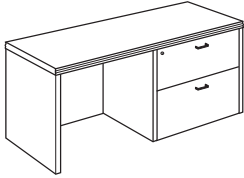
Description

- Central Locking
- Two Lateral File Drawers Provide Legal or Letter Filing Front to Back or Side to Side
- Optional Grommet Standard in Back Panel

Item	Model No.	W	D	H	K	R	Ship Wt	Cubic Ft	List Price	
EXECUTIVE MULTI-FILE PEDESTAL CREDENZA BOX/BOX/FILE/LATERAL	Left Ped	Right Ped								
	65-2472LMF	65-2472RMF	72	24	30	12	-	277	35.6	\$ 2977
										CV\$ 3423
	65-2466LMF	65-2466RMF	66	24	30	6	-	264	32.7	\$ 2940
										CV\$ 3379

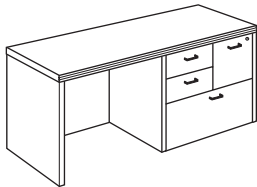
Description

- Locking File Drawers Only
- Box/Box/File/Lateral in Pedestal
- Optional Grommet Standard in Back Panel

All credenzas shown as right.

For ordering options, see back of Gesso Identification card at the beginning of the section.

For grommet options, see page 183.

Item	Model No.	W	D	H	K	R	Ship Wt	Cubic Ft	List Price
TRANSACTION RISER FOR DESKS/CREDENZAS	65-1272TR	72	12	13	-	-	60	9.9	\$ 1020
	For Use with 72" Wide Worksurfaces								CV\$ 1173
	65-1266TR	66	12	13	-	-	52	9.9	\$ 992
	For Use with 66" Wide Worksurfaces								CV\$ 1141

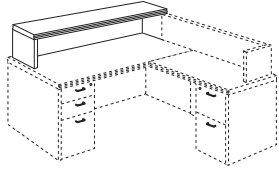
Description

- Freestanding Riser for Desks or Credenzas
- May Be Used in Conjunction with Return Risers or Bridge Risers

TRANSACTION RISER FOR RETURNS	Left Ped	Right Ped	W	D	H	K	R	Ship Wt	Cubic Ft	List Price
		65-1272LU	65-1272RU	72	12	12	-	-	40	9.9
	For Use with 36" Desks and 48" Returns								CV\$ 937	
	65-1266LU	65-1266RU	66	12	12	-	-	35	9.9	\$ 792
	For Use with 30" Desks and 48" Returns								CV\$ 912	

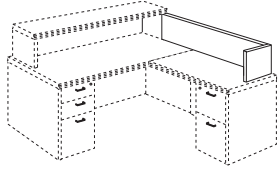
Description

- Must Be Used in Conjunction with a Desk Riser

TRANSACTION RISER FOR BRIDGES	65-1284BP	84	1	12	-	-	47	2.0	\$ 539
	For Use with 36" Desks, 48" Bridge, and Credenza								CV\$ 619

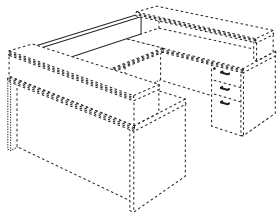

Description

- Must Be Used in Conjunction with Two Desk/Credenza Risers

For ordering options, see back of Gesso Identification card at the beginning of the section.

For grommet options, see page 183.

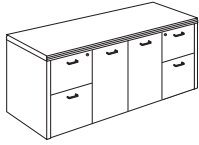
Item	Model No.	W	D	H	K	R	Ship Wt	Cubic Ft	List Price
STORAGE CREDENZA FULL PEDESTAL	67-2472SC	72	24	30	-	-	285	35.6	\$ 3262 CV\$ 3752
	67-2466SC	66	24	30	-	-	261	32.7	\$ 3129 CV\$ 3599

Description

- Letter Width Locking Pedestals
- File/File in Both Pedestals
- Fixed Storage Shelf Behind Doors

STORAGE CREDENZA 3/4 PEDESTAL	65-2472SC	72	24	30	-	-	262	35.6	\$ 2926 CV\$ 3366
	65-2466SC	66	24	30	-	-	240	32.7	\$ 2733 CV\$ 3143

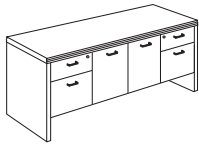
Description

- Letter Width Locking Pedestals
- Box/File in Both Pedestals

KNEESPACE CREDENZA FULL PEDESTAL	67-2472KC	72	24	30	39	-	240	35.6	\$ 3021 CV\$ 3474
	67-2466KC	66	24	30	33	-	220	32.7	\$ 2807 CV\$ 3229

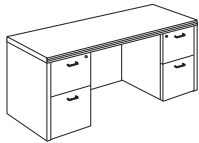
Description

- Letter Width Locking Pedestals
- File/File in Both Pedestals
- Wire Management from Pedestal to Kneespace
- Optional Grommet Standard in Back Panel
- Sit-to-Stand Option Available, See Page 184

KNEESPACE CREDENZA 3/4 PEDESTAL	65-2472KC	72	24	30	39	-	227	35.6	\$ 2681 CV\$ 3083
	65-2466KC	66	24	30	33	-	208	32.7	\$ 2436 CV\$ 2801

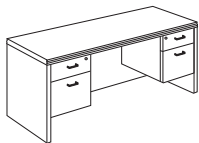
Description

- Letter Width Locking Pedestals
- Box/File in Both Pedestals
- Wire Management from Pedestal to Kneespace
- Optional Grommet Standard in Back Panel

For ordering options, see back of Gesso Identification card at the beginning of the section.

Item	Model No.	W	D	H	K	R	Ship Wt	Cubic Ft	List Price
DOUBLE LATERAL CREDENZA	65-2472DL	72	24	30	-	-	360	35.7	\$ 3929
									CV\$ 4518

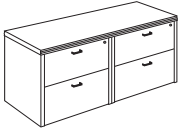
Description

- Dual Locking
- File Drawers Provide Legal or Letter Filing
- 1/4" Thick Drawer Bottoms Allow for Storage Applications

FOUR DRAWER LATERAL FILE	65-2436L4	36	24	57 1/2	-	-	312	32.6	\$ 3379
									CV\$ 3887
	65-2430L4	30	24	57 1/2	-	-	260	27.5	\$ 3220
									CV\$ 3701

Description

- Central Locking
- Anti-Tilt System
- File Drawers Provide Legal or Letter Filing Front to Back or Side to Side
- 1/4" Thick Drawer Bottoms Allow for Storage Applications

TWO DRAWER LATERAL FILE	65-2436L2	36	24	30	-	-	184	18.3	\$ 1786
									CV\$ 2055
	65-2430L2	30	24	30	-	-	153	15.6	\$ 1697
									CV\$ 1951

Description

- Central Locking
- Anti-Tilt System
- File Drawers Provide Legal or Letter Filing Front to Back or Side to Side
- 1/4" Thick Drawer Bottoms Allow for Storage Applications

For ordering options, see back of Gesso Identification card at the beginning of the section.

Item	Model No.	W	D	H	K	R	Ship Wt	Cubic Ft	List Price
MULTI-FILE	65-2436MF	36	24	30	-	-	184	18.3	\$ 2051 CV\$ 2358

Description

- Upper Section - Box/Box/File
- Lower Section - Lateral File
- Locking File Drawers
- One Lateral File Drawer Provides Legal or Letter Filing

MOBILE PEDESTAL	65-1519MP	15 ³ / ₄	19	23	-	-	64	6.3	\$ 1372 CV\$ 1578
-----------------	-----------	--------------------------------	----	----	---	---	----	-----	----------------------

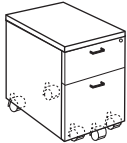
Description

- Letter Width Locking Pedestal
- Box/File in Pedestal
- Casters Allow for Easy Moving
- Fits Underneath 30" H Worksurface

For ordering options, see back of Gesso Identification card at the beginning of the section.

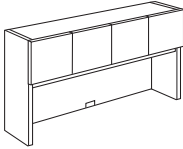
Item	Model No.	W	D	H	K	R	Ship Wt	Cubic Ft	List Price
WOOD DOOR SURFACE MOUNT HUTCHES 	65-15108HU Six Doors	108	15	40 7/8	-	-	206	50.4	\$ 3587 CV\$ 4125
	65-15102HU Six Doors	102	15	40 7/8	-	-	195	47.7	\$ 3437 CV\$ 3952
	65-1596HU Six Doors	96	15	40 7/8	-	-	184	44.9	\$ 3382 CV\$ 3890
	65-1590HU Five Doors	90	15	40 7/8	-	-	172	42.2	\$ 3162 CV\$ 3636
	65-1584HU Five Doors	84	15	40 7/8	-	-	160	39.4	\$ 2724 CV\$ 3132
	65-1578HU Four Doors	78	15	40 7/8	-	-	148	36.7	\$ 2660 CV\$ 3058
	65-1572HU Four Doors	72	15	40 7/8	-	-	201	34.1	\$ 2243 CV\$ 2578
	65-1566HU Four Doors	66	15	40 7/8	-	-	184	32.1	\$ 2162 CV\$ 2486

Description

- Grommet
- Additional support is required when surface mounted hutches do not sit directly over an end panel or pedestal, See page 233 to order 65-2812SP
- Component Hutch Tops with Profiles are Available, See Page 210
- Optional Locking Available on Solid Panel Doors and Wood Framed Doors, See Page 183
- 23 1/8" Clearance Below Doors

Options: Specify & Add

1-AD	Metallic Framed Frosted Acrylic Doors - Non Locking	\$75 per Door
------	---	---------------

1-WF	Wood Framed Frosted Acrylic Doors - Optional Locking Available	\$85 per Door
------	--	---------------

NOTE: Not Available in Composite Veneer

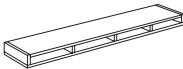
Item	Model No.	W	D	H	K	R	Ship Wt	Cubic Ft	List Price
OPTIONAL PAPER SLOTS FOR SURFACE MOUNT HUTCHES 	65-11106PS Six Slots	106 1/2	11 7/8	5 1/4	-	-	62	4.7	\$ 1483 CV\$ 1706
	65-11100PS Six Slots	100 1/2	11 7/8	5 1/4	-	-	59	4.5	\$ 1391 CV\$ 1599
	65-1194PS Six Slots	94 1/2	11 7/8	5 1/4	-	-	55	4.2	\$ 1297 CV\$ 1491
	65-1188PS Five Slots	88 1/2	11 7/8	5 1/4	-	-	52	3.9	\$ 1203 CV\$ 1384
	65-1182PS Five Slots	82 1/2	11 7/8	5 1/4	-	-	49	3.7	\$ 1109 CV\$ 1276
	65-1176PS Four Slots	76 1/2	11 7/8	5 1/4	-	-	45	3.4	\$ 1015 CV\$ 1168
	65-1170PS Four Slots	70 1/2	11 7/8	5 1/4	-	-	42	3.1	\$ 921 CV\$ 1061
	65-1164PS Four Slots	64 1/2	11 7/8	5 1/4	-	-	38	2.9	\$ 828 CV\$ 952

Description

- Ships Factory Installed

For ordering options, see back of Gesso Identification card at the beginning of the section.

For tackboard and tasklights, see page 244.

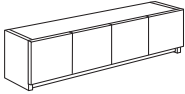
Item	Model No.	W	D	H	K	R	Ship Wt	Cubic Ft	List Price
WOOD DOOR WALL MOUNT HUTCHES 	65-15108WD Six Doors	108	15	17 ³ / ₁₆	-	-	281	55.1	\$ 3228 CV\$ 3711
	65-15102WD Six Doors	102	15	17 ³ / ₁₆	-	-	265	60.7	\$ 3091 CV\$ 3555
	65-1596WD Six Doors	96	15	17 ³ / ₁₆	-	-	249	57.2	\$ 3044 CV\$ 3501
	65-1590WD Five Doors	90	15	17 ³ / ₁₆	-	-	233	53.7	\$ 2844 CV\$ 3272
	65-1584WD Five Doors	84	15	17 ³ / ₁₆	-	-	217	50.2	\$ 2452 CV\$ 2819
	65-1578WD Four Doors	78	15	17 ³ / ₁₆	-	-	201	28.3	\$ 2393 CV\$ 2754
	65-1572WD Four Doors	72	15	17 ³ / ₁₆	-	-	185	43.2	\$ 2012 CV\$ 2315
	65-1566WD Four Doors	66	15	17 ³ / ₁₆	-	-	170	22.0	\$ 1943 CV\$ 2233
	65-1560WD Four Doors	60	15	17 ³ / ₁₆	-	-	155	20.1	\$ 1912 CV\$ 2199
	65-1554WD Three Doors	54	15	17 ³ / ₁₆	-	-	140	18.1	\$ 1778 CV\$ 2046
	65-1548WD Three Doors	48	15	17 ³ / ₁₆	-	-	124	16.2	\$ 1643 CV\$ 1890
	65-1542WD Two Doors	42	15	17 ³ / ₁₆	-	-	109	12.3	\$ 1232 CV\$ 1417
	65-1536WD Two Doors	36	15	17 ³ / ₁₆	-	-	93	12.3	\$ 1074 CV\$ 1235
	65-1530WD Two Doors	30	15	17 ³ / ₁₆	-	-	77	9.1	\$ 930 CV\$ 1070

Description

- Storage Behind Doors
- Component Hutch Tops with Profiles, See Page 210
- Optional Locking Available On Solid Panel Doors and Wood Framed Doors, See Page 183

Options: Specify & Add

1-AD	Metallic Framed Frosted Acrylic Doors - Non Locking	\$75 per Door
------	---	---------------

1-WF	Wood Framed Frosted Acrylic Doors - Optional Locking Available	\$85 per Door
------	--	---------------

NOTE: Not Available in Composite Veneer

NOTE: Indiana Furniture will not be liable for wall mount hutches that are not properly installed.

For ordering options, see back of Gesso Identification card at the beginning of the section.

For tackboard and tasklights, see page 244.

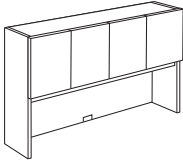
Item	Model No.	W	D	H	K	R	Ship Wt	Cubic Ft	List Price
TALL SURFACE MOUNT DOOR HUTCHES 	65-15108THU Six Doors	108	15	52 7/8	-	-	313	64.2	\$ 4102 CV\$ 4718
	65-15102THU Six Doors	102	15	52 7/8	-	-	296	60.7	\$ 3974 CV\$ 4570
	65-1596THU Six Doors	96	15	52 7/8	-	-	278	57.7	\$ 3902 CV\$ 4487
	65-1590THU Five Doors	90	15	52 7/8	-	-	260	53.7	\$ 3703 CV\$ 4259
	65-1584THU Five Doors	84	15	52 7/8	-	-	243	50.2	\$ 3313 CV\$ 3810
	65-1578THU Four Doors	78	15	52 7/8	-	-	226	46.7	\$ 3249 CV\$ 3736
	65-1572THU Four Doors	72	15	52 7/8	-	-	264	43.3	\$ 2855 CV\$ 3284
	65-1566THU Four Doors	66	15	52 7/8	-	-	242	39.7	\$ 2763 CV\$ 3178

Description

- One Fixed Shelf Behind Doors
- Additional support is required when surface mounted hutches do not sit directly over an end panel or pedestal, See page 233 to order 65-2812SP
- Grommet
- Component Hutch Tops with Profiles, See Page 210
- Optional Locking Available On Solid Panel Doors and Wood Framed Doors, See Page 183
- Optional Paperslots On Solid Panel Doors Only, See Page 204
- 23 1/16" Clearance Below Doors

Options: Specify & Add

1-AD	Metallic Framed Frosted Acrylic Doors - Non Locking	\$167 per Door
------	---	----------------

1-WF	Wood Framed Frosted Acrylic Doors - Optional Locking Available	\$191 per Door
------	--	----------------

NOTE: Not Available in Composite Veneer

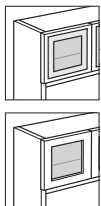

For ordering options, see back of Gesso Identification card at the beginning of the section.

For tackboard and tasklights, see page 244.

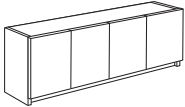
Item	Model No.	W	D	H	K	R	Ship Wt	Cubic Ft	List Price
TALL WALL MOUNT DOOR HUTCHES 	65-15108TWD Six Doors	108	15	29 3/16	-	-	178	19.4	\$ 3796 CV\$ 4366
	65-15102TWD Six Doors	102	15	29 3/16	-	-	168	18.3	\$ 3707 CV\$ 4263
	65-1596TWD Six Doors	96	15	29 3/16	-	-	158	17.3	\$ 3561 CV\$ 4095
	65-1590TWD Five Doors	90	15	29 3/16	-	-	148	16.2	\$ 3240 CV\$ 3727
	65-1584TWD Five Doors	84	15	29 3/16	-	-	138	15.2	\$ 3049 CV\$ 3506
	65-1578TWD Four Doors	78	15	29 3/16	-	-	128	14.1	\$ 2989 CV\$ 3439
	65-1572TWD Four Doors	72	15	29 3/16	-	-	118	13.1	\$ 2632 CV\$ 3027
	65-1566TWD Four Doors	66	15	29 3/16	-	-	105	12.0	\$ 2519 CV\$ 2897
	65-1560TWD Four Doors	60	15	29 3/16	-	-	96	11.0	\$ 2393 CV\$ 2754
	65-1554TWD Three Doors	54	15	29 3/16	-	-	87	9.9	\$ 2210 CV\$ 2542
	65-1548TWD Three Doors	48	15	29 3/16	-	-	77	8.9	\$ 2065 CV\$ 2376
	65-1542TWD Two Doors	42	15	29 3/16	-	-	67	7.8	\$ 1676 CV\$ 1926
	65-1536TWD Two Doors	36	15	29 3/16	-	-	58	6.7	\$ 1580 CV\$ 1816
	65-1530TWD Two Doors	30	15	29 3/16	-	-	48	5.6	\$ 1480 CV\$ 1703

Description

- One Fixed Shelf Behind Doors
- Indiana Furniture will not be liable for wall mount hutches that are not properly installed
- Component Hutch Tops with Profiles, See Page 210
- Optional Locking Available On Solid Panel Doors and Wood Framed Doors, See Page 183

Options: Specify & Add

1-AD	Metallic Framed Frosted Acrylic Doors - Non Locking	\$167 per Door
------	---	----------------

1-WF	Wood Framed Frosted Acrylic Doors - Optional Locking Available	\$191 per Door
------	--	----------------

NOTE: Not Available in Composite Veneer

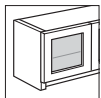
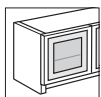

For ordering options, see back of Gesso Identification card at the beginning of the section.

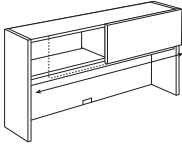
Item	Model No.	W	D	H	K	R	Ship Wt	Cubic Ft	List Price
SURFACE MOUNT SLIDING DOOR HUTCHES 	65-15108SHU Two Doors	108	15	40 7/8	-	-	313	64.2	\$ 4161 CV\$ 4785
	65-15102SHU Two Doors	102	15	40 7/8	-	-	296	60.7	\$ 3867 CV\$ 4446
	65-1596SHU Two Doors	96	15	40 7/8	-	-	278	57.7	\$ 3681 CV\$ 4232
	65-1590SHU Two Doors	90	15	40 7/8	-	-	260	53.7	\$ 3594 CV\$ 4136
	65-1584SHU Two Doors	84	15	40 7/8	-	-	243	50.2	\$ 3088 CV\$ 3553
	65-1578SHU One Door	78	15	40 7/8	-	-	226	46.7	\$ 2955 CV\$ 3400
	65-1572SHU One Door	72	15	40 7/8	-	-	264	43.3	\$ 2591 CV\$ 2978
	65-1566SHU One Door	66	15	40 7/8	-	-	242	39.7	\$ 2513 CV\$ 2890

Description

- Grommet
- Additional support is required when surface mounted hutches do not sit directly over an end panel or pedestal, See page 233 to order 65-2812SP
- Optional Hutch Tops with Profiles are Available, See Page 210
- Optional Paperslots, See Page 204

Options: Specify & Add

1-AD	Metallic Framed Frosted Acrylic Doors	\$215 per Door
------	---------------------------------------	----------------

1-WF	Wood Framed Frosted Acrylic Doors	\$245 per Door
------	-----------------------------------	----------------

NOTE: Not Available in Composite Veneer

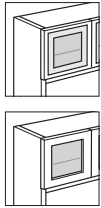

For ordering options, see back of Gesso Identification card at the beginning of the section.

For tackboard and tasklights, see page 244.

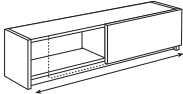
Item	Model No.	W	D	H	K	R	Ship Wt	Cubic Ft	List Price
WALL MOUNT SLIDING DOOR HUTCHES 	65-15108SWD Two Doors	108	15	17 ³ / ₁₆	-	-	281	55.1	\$ 3848 CV\$ 4426
	65-15102SWD Two Doors	102	15	17 ³ / ₁₆	-	-	265	60.7	\$ 3664 CV\$ 4212
	65-1596SWD Two Doors	96	15	17 ³ / ₁₆	-	-	249	57.2	\$ 3505 CV\$ 4031
	65-1590SWD Two Doors	90	15	17 ³ / ₁₆	-	-	233	53.7	\$ 3283 CV\$ 3775
	65-1584SWD Two Doors	84	15	17 ³ / ₁₆	-	-	217	50.2	\$ 2981 CV\$ 3428
	65-1578SWD One Door	78	15	17 ³ / ₁₆	-	-	201	28.3	\$ 2839 CV\$ 3265
	65-1572SWD One Door	72	15	17 ³ / ₁₆	-	-	185	43.2	\$ 2633 CV\$ 3028
	65-1566SWD One Door	66	15	17 ³ / ₁₆	-	-	170	22.0	\$ 2531 CV\$ 2910

Description

- Optional Hutch Tops with Profiles are Available, See Page 210

Options: Specify & Add

1-AD	Metallic Framed Frosted Acrylic Doors	\$215 per Door
------	---------------------------------------	----------------

1-WF	Wood Framed Frosted Acrylic Doors	\$245 per Door
------	-----------------------------------	----------------

NOTE: Not Available in Composite Veneer

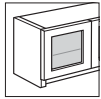
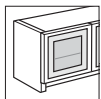

NOTE: Indiana Furniture will not be liable for wall mount hutches that are not properly installed.

For ordering options, see back of Gesso Identification card at the beginning of the section.

For tackboard and tasklights, see page 244.

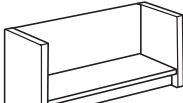
Item	Model No.	W	D	H	K	R	Ship Wt	Cubic Ft	List Price
OPEN STORAGE WALL MOUNT HUTCH 	65-1542WN	42	14 1/4	17 3/16	-	-	55	7.8	\$ 1175 CV\$ 1352
	65-1536WN	36	14 1/4	17 3/16	-	-	42	6.7	\$ 1023 CV\$ 1176
	65-1530WN	30	14 1/4	17 3/16	-	-	36	5.6	\$ 892 CV\$ 1026

Description

- Open Shelf Storage

NOTE: Indiana Furniture will not be liable for wall mount hutches that are not properly installed.

Item	Model No.	W	D	H	K	R	Ship Wt	Cubic Ft	List Price
COMPONENT TOP FOR 15" DEEP HUTCHES & BOOKCASES 	65-15108HT	108	15	1 3/16	-	-	67	5.7	\$ 680 CV\$ 783
	65-15102HT	102	15	1 3/16	-	-	63	5.4	\$ 667 CV\$ 768
	65-1596HT	96	15	1 3/16	-	-	61	5.1	\$ 642 CV\$ 740
	65-1590HT	90	15	1 3/16	-	-	57	4.8	\$ 615 CV\$ 706
	65-1584HT	84	15	1 3/16	-	-	53	4.5	\$ 589 CV\$ 677
	65-1578HT	78	15	1 3/16	-	-	50	4.2	\$ 574 CV\$ 662
	65-1572HT	72	15	1 3/16	-	-	48	3.9	\$ 534 CV\$ 615
	65-1566HT	66	15	1 3/16	-	-	42	3.5	\$ 511 CV\$ 589
	65-1560HT	60	15	1 3/16	-	-	38	3.2	\$ 499 CV\$ 573
	65-1554HT	54	15	1 3/16	-	-	34	2.9	\$ 489 CV\$ 562
	65-1548HT	48	15	1 3/16	-	-	30	2.6	\$ 476 CV\$ 549
	65-1542HT	42	15	1 3/16	-	-	27	2.3	\$ 461 CV\$ 530
	65-1536HT	36	15	1 3/16	-	-	23	2.0	\$ 443 CV\$ 509
	65-1530HT	30	15	1 3/16	-	-	11	1.0	\$ 429 CV\$ 494

Description

- Provides an Edge Profile on Overhead Units While Giving Multiple Overhead Units a Cohesive Appearance
- Profiled on Front Edge Only
- Not Intended for Open Hutches

For ordering options, see back of Gesso Identification card at the beginning of the section.

Item	Model No.	W	D	H	K	R	Ship Wt	Cubic Ft	List Price
------	-----------	---	---	---	---	---	---------	----------	------------

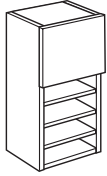
STORAGE TOWER

Hinged Left	Hinged Right	W	D	H	K	R	Ship Wt	Cubic Ft	List Price
65-1518HL1	65-1518HR1	18	15	40 7/8	-	-	84	8.1	\$ 1248
									CV\$ 1435

Description

- Storage Behind Door in Upper Section
- Three Adjustable Shelves

Options: Specify & Add

1-AD	Metallic Framed Frosted Acrylic Doors	\$	75
------	---------------------------------------	----	----

1-WF	Wood Framed Frosted Acrylic Doors	\$	85
------	-----------------------------------	----	----

NOTE: Not Available in Composite Veneer

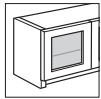
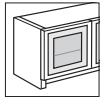
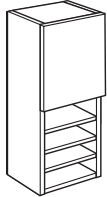
TALL STORAGE TOWER

Hinged Left	Hinged Right	W	D	H	K	R	Ship Wt	Cubic Ft	List Price
65-1518THL1	65-1518THR1	18	15	52 7/8	-	-	95	11.0	\$ 1525
									CV\$ 1753

Description

- Storage Behind Door in Upper Section with One Adjustable Shelf
- Three Adjustable Shelves in Lower Section

Options: Specify & Add

1-AD	Metallic Framed Frosted Acrylic Doors	\$	167
------	---------------------------------------	----	-----

1-WF	Wood Framed Frosted Acrylic Doors	\$	191
------	-----------------------------------	----	-----

NOTE: Not Available in Composite Veneer

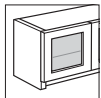
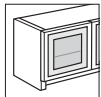
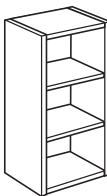
**STORAGE TOWER
OPEN BOOKCASE**

65-1518HB	18	14 1/4	40 7/8	-	-	67	7.9	\$ 907	
									CV\$ 1041

Description

- Two Adjustable Shelves

For ordering options, see back of Gesso Identification card at the beginning of the section.

Item	Model No.	W	D	H	K	R	Ship Wt	Cubic Ft	List Price
STORAGE TOWER	Hinged Left								
	Hinged Right								
	65-1518HL3	18	15	40 7/8	-	-	84	8.1	\$ 1194
									CV\$ 1372

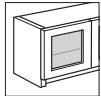
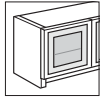
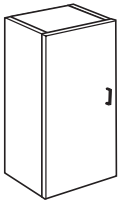
Description

- Two Adjustable Shelves

Options: Specify & Add

1-AD	Metallic Framed Frosted Acrylic Doors	\$ 204
------	---------------------------------------	--------

1-WF	Wood Framed Frosted Acrylic Doors	\$ 234
------	-----------------------------------	--------

NOTE: Not Available in Composite Veneer



NOTE: A capsule pull will be substituted for Elite, Buckle, or Groove pulls.

Item	Model No.	W	D	H	K	R	Ship Wt	Cubic Ft	List Price
TALL STORAGE TOWER	Hinged Left								
	Hinged Right								
	65-1518THL3	18	15	52 7/8	-	-	95	11.0	\$ 1416
									CV\$ 1629

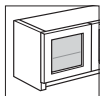
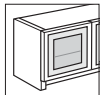
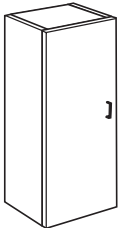
Description

- Three Adjustable Shelves

Options: Specify & Add

1-AD	Metallic Framed Frosted Acrylic Doors	\$ 267
------	---------------------------------------	--------

1-WF	Wood Framed Frosted Acrylic Doors	\$ 304
------	-----------------------------------	--------

NOTE: Not Available in Composite Veneer



NOTE: A capsule pull will be substituted for Elite, Buckle, or Groove pulls.

Item	Model No.	W	D	H	K	R	Ship Wt	Cubic Ft	List Price
TALL STORAGE TOWER OPEN BOOKCASE	65-1518THB	18	14 1/4	52 7/8	-	-	68	11.0	\$ 1079 CV\$ 1242

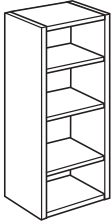
Description

- Three Adjustable Shelves

TOP UNIT DOOR BOOKCASE	65-1536TUDB	36	15	40 7/8	-	-	168	16.1	\$ 1710 CV\$ 1968
	65-1530TUDB	30	15	40 7/8	-	-	140	13.4	\$ 1587 CV\$ 1825

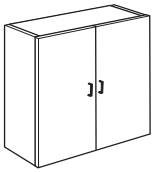
Description

- One Fixed Shelf
- Two Adjustable Shelves

Options: Specify & Add

1-AD	Metallic Framed Frosted Acrylic Doors	\$ 407
------	---------------------------------------	--------



1-WF	Wood Framed Frosted Acrylic Doors	\$ 467
------	-----------------------------------	--------



NOTE: Not Available in Composite Veneer



NOTE: A capsule pull will be substituted for Elite, Buckle, or Groove pulls.

TALL TOP UNIT DOOR BOOKCASE	65-1536TTUDB	36	15	52 7/8	-	-	216	20.5	\$ 2009 CV\$ 2311
	65-1530TTUDB	30	15	52 7/8	-	-	129	14.9	\$ 1825 CV\$ 2098

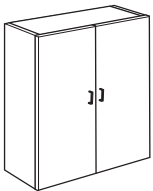
Description

- One Fixed Shelf
- Three Adjustable Shelves

Options: Specify & Add

1-AD	Metallic Framed Frosted Acrylic Doors	\$ 533
------	---------------------------------------	--------



1-WF	Wood Framed Frosted Acrylic Doors	\$ 607
------	-----------------------------------	--------



NOTE: Not Available in Composite Veneer



NOTE: A capsule pull will be substituted for Elite, Buckle, or Groove pulls.

For ordering options, see back of Gesso Identification card at the beginning of the section.

Item	Model No.	W	D	H	K	R	Ship Wt	Cubic Ft	List Price	
STORAGE CABINET FILE/FILE	Hinged Left									
	Hinged Right									
	65-1872DS2L	65-1872DS2R	18	24	70 7/8	-	-	145	22.0	\$ 2735
										CV\$ 3147

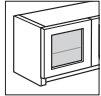
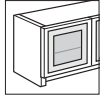
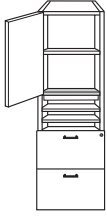
Description

- One Adjustable Shelf Behind Door
- Two Adjustable Shelves in Center Section
- File/File in Lower Section Lock and Provide Legal or Letter Filing

Options: Specify & Add

1-AD	Metallic Framed Frosted Acrylic Doors	\$ 167
------	---------------------------------------	--------

1-WF	Wood Framed Frosted Acrylic Doors	\$ 191
------	-----------------------------------	--------

NOTE: Not Available in Composite Veneer

Item	Model No.	W	D	H	K	R	Ship Wt	Cubic Ft	List Price	
STORAGE CABINET BOX/BOX/FILE	Hinged Left									
	Hinged Right									
	65-1872DS1L	65-1872DS1R	18	24	70 7/8	-	-	145	22.0	\$ 2735
										CV\$ 3147

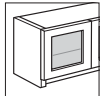
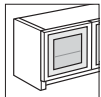
Description

- One Adjustable Shelf Behind Door
- Two Adjustable Shelves in Center Section
- Box/Box/File in Lower Section Lock and Provide Legal or Letter Filing

Options: Specify & Add

1-AD	Metallic Framed Frosted Acrylic Doors	\$ 167
------	---------------------------------------	--------

1-WF	Wood Framed Frosted Acrylic Doors	\$ 191
------	-----------------------------------	--------

NOTE: Not Available in Composite Veneer

Item	Model No.	W	D	H	K	R	Ship Wt	Cubic Ft	List Price	
STORAGE CABINET FILE/FILE	Hinged Left									
	Hinged Right									
	65-1872WFL	65-1872WFR	18	24	70 7/8	-	-	145	22.0	\$ 2542
										CV\$ 2923

Description

- Two Adjustable Shelves Behind Door
- File/File in Lower Section Lock and Provide Legal or Letter Filing

NOTE: A capsule pull will be substituted for Elite, Buckle, or Groove pulls on door only.

For ordering options, see back of Gesso Identification card at the beginning of the section.

Item	Model No.	W	D	H	K	R	Ship Wt	Cubic Ft	List Price
STORAGE CABINET BOX/BOX/FILE	Hinged Left								
	Hinged Right								
	65-1872WBL	18	24	70 7/8	-	-	145	22.0	\$ 2542 CV\$ 2923

Description

- Two Adjustable Shelves Behind Door
- Box/Box/File in Lower Section Lock and Provide Legal or Letter Filing



NOTE: A capsule pull will be substituted for Elite, Buckle, or Groove pulls on door only.

OPEN STORAGE CABINET FILE/FILE	65-1872WFO	18	24	70 7/8	-	-	136	22.0	\$ 2339 CV\$ 2691
-----------------------------------	------------	----	----	--------	---	---	-----	------	----------------------

Description

- Two Adjustable Shelves in Upper Section
- File/File in Lower Section Lock and Provide Legal or Letter Filing

OPEN STORAGE CABINET BOX/BOX/FILE	65-1872WBO	18	24	70 7/8	-	-	136	22.0	\$ 2339 CV\$ 2691
--------------------------------------	------------	----	----	--------	---	---	-----	------	----------------------



Description

- Two Adjustable Shelves in Upper Section
- Box/Box/File in Lower Section Lock and Provide Legal or Letter Filing

For ordering options, see back of Gesso Identification card at the beginning of the section.

Item	Model No.	W	D	H	K	R	Ship Wt	Cubic Ft	List Price
------	-----------	---	---	---	---	---	---------	----------	------------

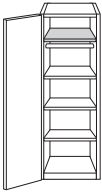
WARDROBE/STORAGE CABINET	Hinged Left	Hinged Right	18	24	70 7/8	-	-	153	19.2	\$ 2301
	65-1872WL	65-1872WR								

Description

- Fixed Top Shelf
- Coat Rod Under Fixed Shelf
- Three Adjustable Shelves
- Adjustable Shelves can be Removed for Wardrobe Application

Options

1-LOCK	Optional Locking	\$ 43
--------	------------------	-------



NOTE: A capsule pull will be substituted for Elite, Buckle, or Groove pulls.

WARDROBE/STORAGE CABINET	65-3672WDS2	36	24	70 7/8	-	-	315	42.0	\$ 3775
--------------------------	-------------	----	----	--------	---	---	-----	------	---------

CV\$ 4340

Description

- Left Side Equipped with Coat Rod
- Right Side Upper Section has Storage Behind Two Hutch Style Doors
- Right Middle Section has Two Adjustable Shelves
- Right Lower Section has Two Lateral File Drawers that Lock and Provide Legal or Letter Filing

Options: Specify & Add

1-AD	Metallic Framed Frosted Acrylic Hutch Doors	\$ 149
------	---	--------

1-WF	Wood Framed Frosted Acrylic Hutch Doors	\$ 172
------	---	--------

NOTE: Not Available in Composite Veneer

PORTABLE PAPERSLOT TOWER	65-1218HH	18	12	21	-	-	50	4.50	\$ 929
--------------------------	-----------	----	----	----	---	---	----	------	--------

CV\$ 1069

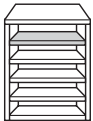
Description

- Three Adjustable Shelves

For ordering options, see back of Gesso Identification card at the beginning of the section.

Item	Model No.	W	D	H	K	R	Ship Wt	Cubic Ft	List Price
VISUAL BOARD	65-4848VB	48	5	48	-	-	150	11.0	\$ 3100 CV\$ 3565

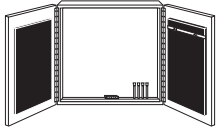

Description

- Tackboard on Each Door is Standard in Black Fabric Unless Specified
- Price Valid for Fabric Grades 1, 2, and 3
- Display Rail with Adjustable Hooks for Flipchart
- Flipchart
- Magnetic Porcelain Non-Glare Writing Surface
- Set of Four Dry Markers and Eraser
- Shipped with Appropriate Rails for Mounting

Options: Specify & Add	Grade 4	Grade 5	Grade 6	Grade 7	Grade 8	Grade 9	Grade 10
Tackboard	\$ 181	\$ 263	\$ 354	\$ 473	\$ 601	\$ 753	\$ 926

1-PS Optional Factory Installed Projection Screen	\$ 667
---	--------



NOTE: A capsule pull will be substituted for Elite, Buckle, or Groove pulls.
NOTE: Indiana Furniture will not be liable for visual boards that are not properly installed.

WARDROBE/STORAGE CABINET	Model No.	W	D	H	K	R	Ship Wt	Cubic Ft	List Price
	65-3672WC	36	24	70 7/8	-	-	290	42.0	\$ 3190 CV\$ 3669
	65-3072WC	30	24	70 7/8	-	-	240	35.7	\$ 3106 CV\$ 3570

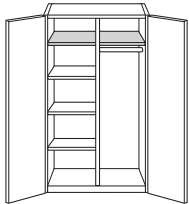

Description

- Storage Behind Two Doors
- Fixed Top Shelf
- Three Adjustable Shelves on Left Side
- Coat Rod on Right Side

Options

1-LOCK Optional Locking	\$ 58
-------------------------	-------



NOTE: A capsule pull will be substituted for Elite, Buckle, or Groove pulls.

For ordering options, see back of Gesso Identification card at the beginning of the section.

For tackboard and tasklights, see page 244.

Item	Model No.	W	D	H	K	R	Ship Wt	Cubic Ft	List Price
1/4 ROUND BOOKCASE	65-1472QR	14	14	70 7/8	-	-	130	10.8	\$ 1323 CV\$ 1523

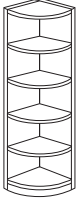

Description

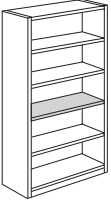
- Four Fixed Shelves
- Must Not be Used as Freestanding

BOOKCASES	Model No.	W	D	H	K	R	Ship Wt	Cubic Ft	List Price
	65-3672BC Three Adjustable Shelves - One Fixed Shelf	36	14 1/4	70 7/8	-	-	176	26.9	\$ 2038 CV\$ 2344
	65-3072BC Three Adjustable Shelves - One Fixed Shelf	30	14 1/4	70 7/8	-	-	146	23.3	\$ 1669 CV\$ 1921
	65-3660BC Three Adjustable Shelves	36	14 1/4	58 7/8	-	-	147	23.2	\$ 1758 CV\$ 2022
	65-3060BC Three Adjustable Shelves	30	14 1/4	58 7/8	-	-	122	19.5	\$ 1465 CV\$ 1686
	65-3648BC Two Adjustable Shelves	36	14 1/4	46 7/8	-	-	120	18.7	\$ 1623 CV\$ 1866
	65-3048BC Two Adjustable Shelves	30	14 1/4	46 7/8	-	-	100	15.7	\$ 1261 CV\$ 1451
	65-3630BC One Adjustable Shelf; Top Profiled on Front Edge	36	14 1/4	30	-	-	75	11.9	\$ 1231 CV\$ 1416
	65-3030BC One Adjustable Shelf; Top Profiled on Front Edge	30	14 1/4	30	-	-	62	10.1	\$ 1036 CV\$ 1193

Description

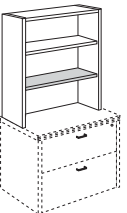
- 1" Thick Shelves

TOP UNIT BOOKCASE	Model No.	W	D	H	K	R	Ship Wt	Cubic Ft	List Price
	65-1536TU One Adjustable Shelf	36	14 1/4	40 7/8	-	-	98	15.9	\$ 1125 CV\$ 1294
	65-1530TU One Adjustable Shelf	30	14 1/4	40 7/8	-	-	127	16.4	\$ 1036 CV\$ 1193

Description

- Fixed Bottom Shelf with 12" Clearance
- For Use on Two Drawer Lateral Files
- 1" Thick Shelves

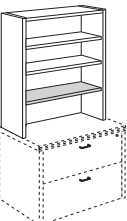
TALL TOP UNIT BOOKCASE	Model No.	W	D	H	K	R	Ship Wt	Cubic Ft	List Price
	65-1536TTU	36	14 1/4	52 7/8	-	-	169	22.2	\$ 1421 CV\$ 1635
	65-1530TTU	30	14 1/4	52 7/8	-	-	129	14.9	\$ 1294 CV\$ 1488

Description

- One Fixed Shelf
- Two Adjustable Shelves

For ordering options, see back of Gesso Identification card at the beginning of the section.

Item	Model No.	W	D	H	K	R	Ship Wt	Cubic Ft	List Price
STORAGE CABINET WITH LATERAL FILES	65-3672SU2	36	24	70 7/8	-	-	298	42.0	\$ 3872 CV\$ 4452
	65-3072SU2	30	24	70 7/8	-	-	251	35.7	\$ 3783 CV\$ 4351

Description

- Top - Two Doors with Two Adjustable Shelves
- Bottom - File/File
- Locking Drawers
- File Drawers Provide Legal or Letter Filing

NOTE: A capsule pull will be substituted on upper doors for Elite, Buckle, or Groove pulls.

BUFFET CREDENZA	65-2472BF	72	24	36	-	-	342	45.5	\$ 3792 CV\$ 4361
-----------------	-----------	----	----	----	---	---	-----	------	----------------------

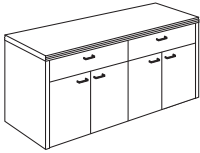
Description

- Two Drawers
- Storage Behind Doors
- Two Adjustable Shelves

SECRET TABLE PENINSULA	01-3660R96H Expands 36"	60-96	36	30	-	-	145	43.6	P\$ 3870
	01-3648R72H Expands 24"	48-72	36	30	-	-	113	35.2	P\$ 3699
	01-3060R96H Expands 36"	60-96	30	30	-	-	120	36.7	P\$ 3808
	01-3048R72H Expands 24"	48-72	30	30	-	-	94	29.6	P\$ 3585

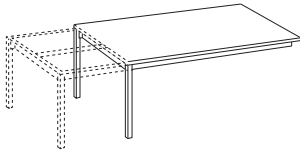
Description

- Aluminum Metal Frame with Aprons
- Expands to Reveal a Hidden Table Leaf
- 3/4" Thick Tops with a Self Edge
- Concealed Casters
- Attaches to Fixed Worksurfaces to Create a Run-Off Peninsula Work Table
- Available with HPL Top Only

SECRET TABLE FREE STANDING	01-3660T96H Expands 36"	60-96	36	30	-	-	150	43.6	P\$ 4691
	01-3060T96H Expands 36"	60-96	30	30	-	-	125	36.7	P\$ 4553

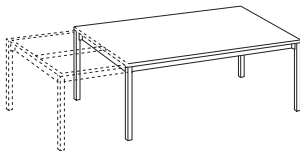
Description

- Aluminum Metal Frame with Aprons
- Expands to Reveal a Hidden Table Leaf
- 3/4" Thick Tops with a Self Edge
- Adjustable Glides on Static Legs and Concealed Casters on Expanding End
- Freestanding Desk or Table
- Available with HPL Top Only

Item	Model No.	W	D	H	K	R	Ship Wt	Cubic Ft	List Price
SECRET TABLE FOR BENCHING	01-3660LT96H Expands 36"	60-96	36	30	-	-	148	43.6	P\$ 4447
	01-3060LT96H Expands 36"	60-96	30	30	-	-	123	36.7	P\$ 4316

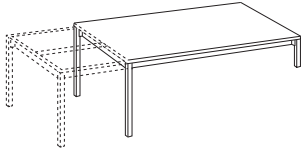
Description

- Aluminum Metal Frame with Aprons
- Expands to Reveal a Hidden Table Leaf
- ¾" Thick Tops with a Self Edge
- Concealed Casters
- Installs Over Benching Units Created with Canvas or Gesso Components
- Available with HPL Top Only

COMPUTER WORK TABLE	65-2442CW	42	24	27	-	-	115	19.2	\$ 1308
									CV\$ 1504
	65-2436CW	36	24	27	-	-	99	16.6	\$ 1283
									CV\$ 1476

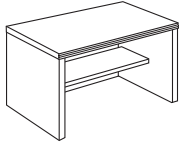

Description

- Fixed Shelf
- Grommet in Back Panel

Options: Specify & Add

CS-66BL	Optional Black Casters								\$ 150
---------	------------------------	--	--	--	--	--	--	--	--------

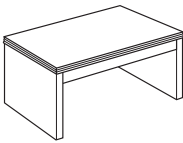
MAGAZINE TABLE	65-2442MT	42	24	16	-	-	70	11.9	\$ 1086
									CV\$ 1248

Description

- Slab Ends
- Apron Rail

END TABLE	65-2424ET	24	24	22	-	-	65	9.4	\$ 1031
									CV\$ 1185

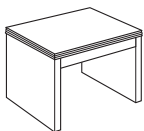
Description

- Slab Ends
- Apron Rail

For ordering options, see back of Gesso Identification card at the beginning of the section.

Item	Model No.	W	D	H	K	R	Ship Wt	Cubic Ft	List Price
CIRCULAR TABLE 	65-4848CT Accommodates 5 Chairs	48	48	1 ³ / ₁₆	-	-	95	4.3	\$ 819 CV\$ 943
	65-4242CT Accommodates 4 Chairs	42	42	1 ³ / ₁₆	-	-	70	3.4	\$ 792 CV\$ 912
	65-3636CT Accommodates 3 Chairs	36	36	1 ³ / ₁₆	-	-	37	2.5	\$ 695 CV\$ 800

Description

- Single Base Required

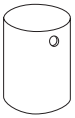
CYLINDER BASE 	01-2020CB For Use with 48" and 42" Circular Tables	20	20	28 1/2	-	-	136	10.8	\$ 977 CV\$ 1123
	01-1616CB For Use with 36" Circular Table	16	16	28 1/2	-	-	101	7.2	\$ 892 CV\$ 1026

Description

- Weighted for Stability
- 2 Wire Management Grommets Standard at the Top with 8" Opening Standard in Bottom

Options: Specify & Add

GCB1S	Optional Grommet Top Edge (1)	\$	N/C
NOGC	Optional No Grommets At Top Edges	\$	N/C

METAL BASE  Open Market Only	01-0400MBB Black Metal Base	32	32	27 3/4	-	-	32	3.2	\$ 632
	01-0400MBA Aluminum Metal Base	32	32	27 3/4	-	-	32	3.2	\$ 632

Description

- Shipped KD - Some Assembly Required
- Can be Used with 42" or 36" Circular Tables



NOTE: For 48" Tops, use 01-0404MB, see Resilience Casegood Series

CENTER DRAWER 	65-1622CD	22	16	2	-	-	7	1.4	\$ 332
--	-----------	----	----	---	---	---	---	-----	--------

Description

- Fits Desks, P-Top Units, and D-Top Units
- Will Not Work in Conjunction with Modesty Panels on 30" D-Top Units

Options: Specify & Add

Factory Installed	\$	130
-------------------	----	-----

For ordering options, see back of Gesso Identification card at the beginning of the section.

Item	Model No.	W	D	H	K	R	Ship Wt	Cubic Ft	List Price	
P-TOP PENINSULA WITH CYLINDER BASE	Left Top	Right Top								
	65-4284TL	65-4284TR	84	42-36	30	-	-	120	13.2	\$ 2291 CV\$ 2634
	65-4272TL	65-4272TR	72	42-36	30	-	-	115	11.3	\$ 1879 CV\$ 2161

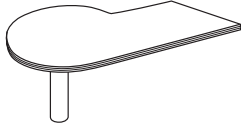
Description

- Metal Cylinder Base Standard - 4" Diameter. Must Specify: Black or Aluminum.
- Shipped KD
- Stiffener Bars are Required on 84" Units in Run Off Applications, See Page 236
- Component Pedestals Cannot be Used in Combination with Sit-to-Stand Options

D-TOP PENINSULA WITH CYLINDER BASE	65-3684DR	84	36	30	-	-	134	13.2	\$ 2248 CV\$ 2586
	65-3672DR	72	36	30	-	-	115	9.8	\$ 1895 CV\$ 2179
	65-3066DR	66	30	30	-	-	120	7.5	\$ 2109 CV\$ 2426

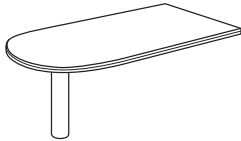
Description

- Metal Cylinder Base Standard - 4" Diameter. Must Specify: Black or Aluminum.
- Shipped KD
- Stiffener Bars are Required on 84" Units in Run Off Applications, See Page 236
- Component Pedestals Cannot be Used in Combination with Sit-to-Stand Options

DESK SHELL	65-3672SH	72	36	30	-	10 1/8	200	52.1	\$ 1925 CV\$ 2214
------------	-----------	----	----	----	---	--------	-----	------	----------------------

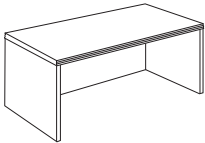
Description

- For Use with or without Modular Pedestals
- Recessed Front
- Sit-to-Stand Option Available, See Page 184

CREDENZA SHELL	65-2472SH	72	24	30	-	-	135	35.6	\$ 1667 CV\$ 1918
----------------	-----------	----	----	----	---	---	-----	------	----------------------

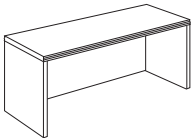
Description

- For Use with or without Modular Pedestals
- Sit-to-Stand Option Available, See Page 184

For ordering options, see back of Gesso Identification card at the beginning of the section.

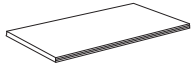
Item	Model No.	W	D	H	K	R	Ship Wt	Cubic Ft	List Price
	65-3672TP	72	36	1 3/16	-	-	115	6.2	\$ 810 CV\$ 931
	65-3072TP	72	30	1 3/16	-	-	85	4.6	\$ 756 CV\$ 871
	65-3066TP	66	30	1 3/16	-	-	80	4.2	\$ 730 CV\$ 839
	65-3060TP	60	30	1 3/16	-	-	75	3.8	\$ 672 CV\$ 774

Description

- For Use as a Desk Top
- Profiled on Approach and User Side
- Stiffener Bars are Recommended in Peninsula Applications, See Page 236
- For Power and Data, See 1-DPORT on See Page 237

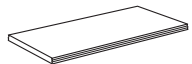
Item	Model No.	W	D	H	K	R	Ship Wt	Cubic Ft	List Price
	65-24108TP	108	24	1 3/16	-	-	106	6.6	\$ 819 CV\$ 943
	65-24102TP	102	24	1 3/16	-	-	104	6.3	\$ 801 CV\$ 920
	65-2496TP	96	24	1 3/16	-	-	100	5.0	\$ 783 CV\$ 901
	65-2490TP	90	24	1 3/16	-	-	95	4.6	\$ 764 CV\$ 879
	65-2484TP	84	24	1 3/16	-	-	90	4.3	\$ 700 CV\$ 806
	65-2478TP	78	24	1 3/16	-	-	85	4.0	\$ 684 CV\$ 785
	65-2472TP	72	24	1 3/16	-	-	80	3.7	\$ 665 CV\$ 764
	65-2466TP	66	24	1 3/16	-	-	75	3.4	\$ 635 CV\$ 730
	65-2460TP For Front to Back Grain Use 65-6024TP	60	24	1 3/16	-	-	70	3.0	\$ 608 CV\$ 698
	65-2454TP For Front to Back Grain Use 65-5424TP	54	24	1 3/16	-	-	65	2.8	\$ 557 CV\$ 640
	65-2448TP For Front to Back Grain Use 65-4824TP	48	24	1 3/16	-	-	55	2.5	\$ 516 CV\$ 592
	65-2442TP For Front to Back Grain Use 65-4224TP	42	24	1 3/16	-	-	50	2.2	\$ 469 CV\$ 539
	65-2436TP For Front to Back Grain Use 65-3624TP	36	24	1 3/16	-	-	45	2.0	\$ 414 CV\$ 476
	65-2430TP For Front to Back Grain Use 65-3024TP	30	24	1 3/16	-	-	36	1.6	\$ 400 CV\$ 461
	65-2418TP	18	24	1 3/16	-	-	28	1.0	\$ 369 CV\$ 424

Description

- For Use as a Bridge, Return, or Credenza Top
- Profiled on User/Front Edge Only
- If Modular Tops will have a Kneespace Area of 60" or Greater, a Support Panel is Required, See Page 233
- Stiffener Bar may be Required

For ordering options, see back of Gesso Identification card at the beginning of the section.

For grommet options, see page 183.

For table lifts, see page 238-239.

Item	Model No.	W	D	H	K	R	Ship Wt	Cubic Ft	List Price	
MODULAR PEDESTAL BOX/BOX/FILE 	65-3618PD1	18	35 1/4	28 1/4	-	-	125	13.6	\$ 1618	
	Use with Component Tops									
	CV\$	1861								
	65-3018PD1	18	29 1/4	28 1/4	-	-	105	11.6	\$ 1499	
	Use with Component Tops									
	CV\$	1724								
65-2515SHPD1	15 3/4	25	28 1/4	-	-	96	8.4	\$ 1278		
Use with 65-3672SH										
CV\$	1469									
65-2415PD1	15 3/4	23 1/4	28 1/4	-	-	93	7.8	\$ 1323		
Use with Component Tops and Shells										
CV\$	1523									
65-2418PD1	18	23 1/4	28 1/4	-	-	98	8.9	\$ 1396		
Use with Component Tops and Shells										
CV\$	1606									

Description

- Modular Pedestal
- Box/Box/File Pedestal
- Open Back
- Top is Required
- Locking

MODULAR PEDESTAL FILE/FILE 	65-3618PD2	18	35 1/4	28 1/4	-	-	125	13.6	\$ 1618	
	Use with Component Tops									
	CV\$	1861								
	65-3018PD2	18	29 1/4	28 1/4	-	-	105	11.6	\$ 1499	
	Use with Component Tops									
	CV\$	1724								
65-2515SHPD2	15 3/4	25	28 1/4	-	-	96	8.4	\$ 1278		
Use with 65-3672SH										
CV\$	1469									
65-2415PD2	15 3/4	23 1/4	28 1/4	-	-	93	7.8	\$ 1323		
Use with Component Tops and Shells										
CV\$	1523									
65-2418PD2	18	23 1/4	28 1/4	-	-	98	8.9	\$ 1396		
Use with Component Tops and Shells										
CV\$	1606									

Description

- Modular Pedestal
- File/File Pedestal
- Open Back
- Top is Required
- Locking

Item	Left	Right	W	D	H	K	R	Ship Wt	Cubic Ft	List Price
	MODULAR PEDESTAL DOOR BOOKCASE	65-2418PD4L	65-2418PD4R	18	23 1/4	28 1/4	-	-	90	8.9
										CV\$ 1294

Description

- Modular Pedestal
- Adjustable Shelf
- Open Back
- Top is Required

For ordering options, see back of Gesso Identification card at the beginning of the section.

Item	Model No.	W	D	H	K	R	Ship Wt	Cubic Ft	List Price
MODULAR PEDESTAL OPEN MULTI-FILE	65-2436OMF	36	23 1/4	28 1/4	-	-	118	14.9	\$ 1841 CV\$ 2117
	65-2430OMF	30	23 1/4	28 1/4	-	-	128	18.5	\$ 1768 CV\$ 2033

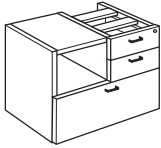
Description

- Upper Section Provides 12 3/4" Clearance for Open Storage and Two Box Drawers
- Lateral File in Lower Section Provides Legal or Letter Filing
- Locking
- Legal or Letter Filing Front to Back or Side to Side
- Open Back

MODULAR PEDESTAL LATERAL FILE	65-2436LF1	36	23 1/4	28 1/4	-	-	154	18.5	\$ 1667 CV\$ 1918
	65-2430LF1	30	23 1/4	28 1/4	-	-	128	14.9	\$ 1551 CV\$ 1783

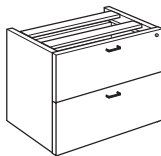
Description

- Modular Pedestal for 24" Deep Tops
- Open Back
- Top is Required
- Legal or Letter Filing Front to Back or Side to Side
- Locking

MODULAR PEDESTAL MULTI-FILE	65-2436LF2	36	23 1/4	28 1/4	-	-	153	18.5	\$ 1915 CV\$ 2201
	65-2430LF2	30	23 1/4	28 1/4	-	-	128	14.9	\$ 1843 CV\$ 2120

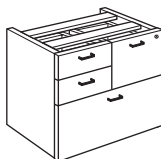
Description

- Modular Pedestal for 24" Deep Tops
- Locking File Drawers Only
- Open Back
- Top is Required

For ordering options, see back of Gesso Identification card at the beginning of the section.

Item	Model No.	W	D	H	K	R	Ship Wt	Cubic Ft	List Price
MODULAR PEDESTAL DOOR BOOKCASE	65-2436DB	36	23 1/4	28 1/4	-	-	105	18.5	\$ 1584 CV\$ 1820
	65-2430DB	30	23 1/4	28 1/4	-	-	87	14.9	\$ 1252 CV\$ 1440

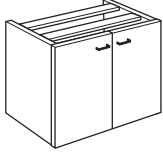

Description

- Modular Pedestal for 24" Deep Tops
- Open Back
- Top is Required
- Adjustable Shelf Behind Doors

Options: Specify & Add

1-LOCK	Optional Door Lock	\$ 58
--------	--------------------	-------

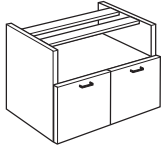
MODULAR PEDESTAL DOOR BOOKCASE W/OPEN COMPARTMENT	65-2436ODB	36	23 1/4	28 1/4	-	-	108	14.9	\$ 1494 CV\$ 1717
	65-2430ODB	30	23 1/4	28 1/4	-	-	118	18.5	\$ 1156 CV\$ 1329

Description

- Upper Section Provides 12 3/4" Clearance for Open Storage
- Lower Section Provides Storage Behind Two Doors
- Open Back

MODULAR PEDESTAL OPEN STORAGE	65-2436MBC	36	22 15/32	28 1/4	-	-	108	14.9	\$ 1292 CV\$ 1487
	65-2430MBC	30	22 15/32	28 1/4	-	-	118	18.5	\$ 1097 CV\$ 1262

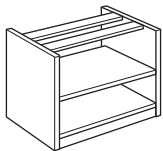
Description

- One Adjustable Shelf
- Open Back

For ordering options, see back of Gesso Identification card at the beginning of the section.

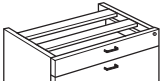
Item	Model No.	W	D	H	K	R	Ship Wt	Cubic Ft	List Price
LOW HEIGHT MODULAR PEDESTAL TRAY/FILE 	65-2436LTF	36	23 1/4	16 1/4	-	-	115	10.3	\$ 1319 CV\$ 1519
	65-2430LTF	30	23 1/4	16 1/4	-	-	96	8.6	\$ 1267 CV\$ 1456
	65-2418LTF	18	23 1/4	16 1/4	-	-	48	5.4	\$ 1076 CV\$ 1237

Description

- For Low Height Credenzas or Benching Applications
- Locking Tray/File
- File Drawer Provides Legal or Letter Filing
- Open Back

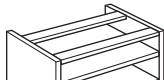
LOW HEIGHT MODULAR PEDESTALS OPEN STORAGE 	65-2436LBC	36	22 15/32	16 1/4	-	-	115	10.3	\$ 1085 CV\$ 1247
	65-2430LBC	30	22 15/32	16 1/4	-	-	96	8.6	\$ 1046 CV\$ 1203
	65-2418LBC	18	22 15/32	16 1/4	-	-	48	5.4	\$ 953 CV\$ 1095

Description

- For Low Height Credenzas or Benching Applications
- One Adjustable Shelf
- Open Back

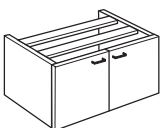
LOW HEIGHT MODULAR PEDESTAL DOOR BOOKCASES 	65-2436LDB	36	23 1/4	16 1/4	-	-	115	10.3	\$ 1236 CV\$ 1421
	65-2430LDB	30	23 1/4	16 1/4	-	-	96	8.6	\$ 1101 CV\$ 1267

Description

- For Low Height Credenzas or Benching Applications
- Open Back

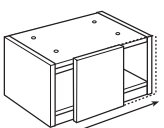
LOW HEIGHT MODULAR PEDESTAL SLIDING DOOR BOOKCASES 	65-2436LSD	36	23 1/4	16 1/4	-	-	115	10.3	\$ 1414 CV\$ 1626
	65-2430LSD	30	23 1/4	16 1/4	-	-	96	8.6	\$ 1245 CV\$ 1429

Description

- For Low Height Credenzas or Benching Applications
- Storage Behind Sliding Door
- Open Back

For ordering options, see back of Gesso Identification card at the beginning of the section.

Item	Model No.	W	D	H	K	R	Ship Wt	Cubic Ft	List Price
SEATED HEIGHT MODULAR PENINSULA SUPPORT	65-3630EP	36	1 3/16	28 1/4	-	-	40	2.0	\$ 446
									CV\$ 511
	65-3030EP	30	1 3/16	28 1/4	-	-	34	1.6	\$ 422
									CV\$ 486
	65-1228RB	12	2	28 1/4	-	-	12	.8	\$ 359
									CV\$ 414

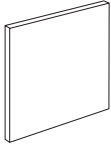
Description

- To Be Used with Modular Desk Tops at 30" High
- Required to Be Used with T Support or the Support Panel Perpendicular to 36" and 30" Unit

SEATED HEIGHT MODULAR PENINSULA SUPPORT	01-3628HLV Single Mount Plate	36	1	28 1/4	-	-	30	2.0	\$ 680
	01-3028HLV Single Mount Plate	30	1	28 1/4	-	-	25	1.7	\$ 669
	01-2428HLV Single Mount Plate	24	1	28 1/4	-	-	20	1.4	\$ 502
	01-3628TLV Double Mount Plate	36	1	28 1/4	-	-	30	2.0	\$ 702
	01-3028TLV Double Mount Plate	30	1	28 1/4	-	-	25	1.7	\$ 690
	01-2428TLV Double Mount Plate	24	1	28 1/4	-	-	20	1.4	\$ 519

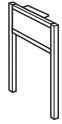

SIN 711-2

Description

- Metal End Support to Be Used with Modular Desk Tops at 30" High
- Select From 5 Powdercoat Finishes
- Double Mount Plate Required for Freestanding Table/Desk

Options: Specify & Add

HIW Wood Insert	\$ 73
-----------------	-------

SEATED HEIGHT MODULAR PENINSULA SUPPORT	01-3628OL	36	2	28 1/4	-	-	30	2.7	\$ 698
	01-3028OL	30	2	28 1/4	-	-	25	2.3	\$ 681
	01-2428OL	24	2	28 1/4	-	-	20	1.8	\$ 667

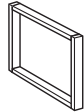

SIN 711-2

Description

- Metal End Support to Be Used with Modular Desk Tops at 30" High
- Select From 5 Powdercoat Finishes

SEATED HEIGHT MODULAR PENINSULA SUPPORT	01-3628UL	36	2	28 1/4	-	-	30	2.7	\$ 739
	01-3028UL	30	2	28 1/4	-	-	25	2.3	\$ 726
	01-2428UL	24	2	28 1/4	-	-	20	1.8	\$ 710

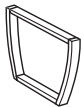

SIN 711-2

Description

- Metal End Support to Be Used with Modular Desk Tops at 30" High
- Select From 5 Powdercoat Finishes

For ordering options, see back of Gesso Identification card at the beginning of the section.

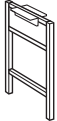
Item	Model No.	W	D	H	K	R	Ship Wt	Cubic Ft	List Price
STANDING HEIGHT MODULAR PENINSULA SUPPORT 	01-3639HLV	36	1	40 1/4	-	-	30	2.7	\$ 721
	01-3039HLV	30	1	40 1/4	-	-	25	2.3	\$ 709
	01-2439HLV	24	1	40 1/4	-	-	20	1.9	\$ 695

Description

- Metal End Support to Be Used with Modular Desk Tops at 41" High
- Select From 5 Powdercoat Finishes
- Not to Be Used to Create a Freestanding Table Desk

Options: Specify & Add

HIW Wood Insert	\$ 73
-----------------	-------

STANDING HEIGHT MODULAR PENINSULA SUPPORT 	01-3639OL	36	2	40 1/4	-	-	30	3.6	\$ 723
	01-3039OL	30	2	40 1/4	-	-	25	3.1	\$ 711
	01-2439OL	24	2	40 1/4	-	-	20	2.5	\$ 696

Description

- Metal End Support to Be Used with Modular Desk Tops at 41" High
- Select From 5 Powdercoat Finishes
- Not to Be Used to Create a Freestanding Table Desk

STANDING HEIGHT MODULAR PENINSULA SUPPORT 	01-3639UL	36	2	40 1/4	-	-	30	3.6	\$ 769
	01-3039UL	30	2	40 1/4	-	-	25	3.1	\$ 754
	01-2439UL	24	2	40 1/4	-	-	20	2.5	\$ 739

Description

- Metal End Support to Be Used with Modular Desk Tops at 41" High
- Select From 5 Powdercoat Finishes
- Not to Be Used to Create a Freestanding Table Desk

For ordering options, see back of Gesso Identification card at the beginning of the section.

Item	Model No.	W	D	H	K	R	Ship Wt	Cubic Ft	List Price
LAYER SUPPORT OVER LOW HEIGHT CABINETS	65-1811USP	18	5 3/4	11	-	-	20	1.2	\$ 371 CV\$ 427

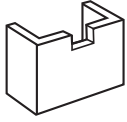
Description

- Supports 30" High Worksurfaces that Overlap Low Height Components
- Open Throughout and On Back Side to Manage Cables

O METAL LAYER SUPPORT OVER LOW HEIGHT CABINETS	01-2411OL	24	2	11	-	-		\$ 641
	01-3011OL	30	2	11	-	-		\$ 655
	01-3611OL	36	2	11	-	-		\$ 667



SIN 711-2

Description

- Supports 30" High Worksurfaces Over Low Height Components
- Select From 5 Powdercoat Finishes

U METAL LAYER SUPPORT OVER LOW HEIGHT CABINETS	01-2411UL	24	2	11	-	-		\$ 672
	01-3011UL	30	2	11	-	-		\$ 686
	01-3611UL	36	2	11	-	-		\$ 699



SIN 711-2

Description

- Supports 30" High Worksurfaces Over Low Height Components
- Select From 5 Powdercoat Finishes

For ordering options, see back of Gesso Identification card at the beginning of the section.

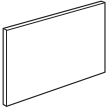
Item	Model No.	W	D	H	K	R	Ship Wt	Cubic Ft	List Price
MODULAR MODESTY PANEL 	65-10828BP	108	3/4	28 1/4	-	-	130	5.7	\$ 679 CV\$ 782
	65-10228BP	102	3/4	28 1/4	-	-	122	5.4	\$ 647 CV\$ 746
	65-9628BP	96	3/4	28 1/4	-	-	115	5.0	\$ 618 CV\$ 713
	65-9028BP	90	3/4	28 1/4	-	-	108	4.6	\$ 606 CV\$ 696
	65-8428BP	84	3/4	28 1/4	-	-	101	4.3	\$ 583 CV\$ 671
	65-7828BP	78	3/4	28 1/4	-	-	94	4.0	\$ 568 CV\$ 654
	65-7228BP	72	3/4	28 1/4	-	-	86	3.7	\$ 554 CV\$ 636
	65-6628BP	66	3/4	28 1/4	-	-	79	3.4	\$ 534 CV\$ 615
	65-6028BP	60	3/4	28 1/4	-	-	72	3.0	\$ 526 CV\$ 605
	65-5428BP	54	3/4	28 1/4	-	-	65	2.8	\$ 500 CV\$ 574
	65-4828BP	48	3/4	28 1/4	-	-	55	2.5	\$ 477 CV\$ 551
	65-4228BP	42	3/4	28 1/4	-	-	50	2.2	\$ 416 CV\$ 477
	65-3628BP	36	3/4	28 1/4	-	-	45	2.0	\$ 358 CV\$ 412
	65-3028BP	30	3/4	28 1/4	-	-	30	1.6	\$ 328 CV\$ 378
	65-1828BP	18	3/4	28 1/4	-	-	19	1.0	\$ 282 CV\$ 324
	65-1528BP	15 3/4	3/4	28 1/4	-	-	18	1.0	\$ 260 CV\$ 298

Description

- For Use as a Modesty Panel to Create Bridges, Returns, or Credenzas
- Grain Runs Vertically Up to 60" - All Larger Sizes are Horizontal Grain Patterns

Options: Specify & Add

1-GRMT	Optional Top-Center Grommet	\$ 48
--------	-----------------------------	-------

FILLER PANEL 	65-2803FP	3	3/4	28 1/4	-	-	6	.5	\$ 220 CV\$ 252
---	-----------	---	-----	--------	---	---	---	----	--------------------

Description

- Used to Fill Gap Behind Modular Pedestals

For ordering options, see back of Gesso Identification card at the beginning of the section.

Item	Model No.	W	D	H	K	R	Ship Wt	Cubic Ft	List Price
LOW HEIGHT BACK PANEL 	65-10816BP	108	3/4	16 1/4	-	-	75	3.4	\$ 564 CV\$ 648
	65-10216BP	102	3/4	16 1/4	-	-	70	3.3	\$ 543 CV\$ 624
	65-9616BP	96	3/4	16 1/4	-	-	65	3.2	\$ 511 CV\$ 589
	65-9016BP	90	3/4	16 1/4	-	-	60	3.1	\$ 500 CV\$ 574
	65-8416BP	84	3/4	16 1/4	-	-	55	3.0	\$ 486 CV\$ 559
	65-7816BP	78	3/4	16 1/4	-	-	50	2.9	\$ 463 CV\$ 532
	65-7216BP	72	3/4	16 1/4	-	-	45	2.8	\$ 443 CV\$ 509
	65-6616BP	66	3/4	16 1/4	-	-	40	2.7	\$ 432 CV\$ 497
	65-6016BP	60	3/4	16 1/4	-	-	35	2.6	\$ 357 CV\$ 411
	65-5416BP	54	3/4	16 1/4	-	-	30	2.5	\$ 336 CV\$ 386
	65-4816BP	48	3/4	16 1/4	-	-	25	2.4	\$ 328 CV\$ 378
	65-4216BP	42	3/4	16 1/4	-	-	20	2.3	\$ 310 CV\$ 356
	65-3616BP	36	3/4	16 1/4	-	-	15	2.2	\$ 298 CV\$ 343
	65-3016BP	30	3/4	16 1/4	-	-	10	2.1	\$ 285 CV\$ 328
	65-1816BP	18	3/4	16 1/4	-	-	5	2.0	\$ 253 CV\$ 293

Description

- For Use as a Modesty Panel to Create Low Height Returns, Credenzas, or Benches
- Grain Runs Vertically Up to 60" - All Larger Sizes are Horizontal Grain Patterns

LOW HEIGHT FILLER PANEL	65-1603FP	3	3/4	16 1/4	-	-	4	.9	\$ 199 CV\$ 228
-------------------------	-----------	---	-----	--------	---	---	---	----	--------------------

Description

- For Low Height Credenzas or Benching Applications
- Used to Fill Gap Behind Modular Pedestals

For ordering options, see back of Gesso Identification card at the beginning of the section.

Item	Model No.	W	D	H	K	R	Ship Wt	Cubic Ft	List Price
FLIPDOWN MODESTY PANEL	65-2836FDM	36	3 1/2	28 1/4	-	-	35	3.3	\$ 1015 CV\$ 1168
	65-2830FDM	30	3 1/2	28 1/4	-	-	30	2.7	\$ 898 CV\$ 1033

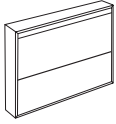
Description

- Modesty Panel with 3" Deep Case Allows Room for Plugs
- Upper Panel is Hinged and Opens Fully to Access Electrical and Data Ports
- Upper Panel is Open at Top for Easy Access and Cord Management

MODULAR END PANEL	65-3530EP	35 1/4	1 3/16	28 1/4	-	-	41	2.6	\$ 442 CV\$ 508
	65-2930EP	29 1/4	1 3/16	28 1/4	-	-	34	2.2	\$ 419 CV\$ 482
	65-2330EP	23 1/4	1 3/16	28 1/4	-	-	27	1.6	\$ 394 CV\$ 453

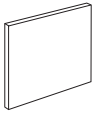
Description

- Required to Be Used with a Backpanel

SUPPORT PANEL	65-2812SP	12	1 3/16	28 1/4	-	-	12	.8	\$ 276 CV\$ 317
---------------	-----------	----	--------	--------	---	---	----	----	--------------------

Description

- Required to be Used Perpendicular to Full Backpanels to Support Kneespace Areas of 60" or Longer

SUPPORT T	65-1010SP	10	10	28 1/4	-	-	12	.9	\$ 400 CV\$ 461
-----------	-----------	----	----	--------	---	---	----	----	--------------------

Description

- Supports Worksurfaces
- Required on Kneespace Areas of 60" or Greater Where Backpanels are Not Used

For ordering options, see back of Gesso Identification card at the beginning of the section.

Item	Model No.	W	D	H	K	R	Ship Wt	Cubic Ft	List Price
LOW HEIGHT END PANEL	65-2416EP	23 1/4	1 3/16	16 1/4	-	-	15	.8	\$ 325 CV\$ 374

Description

- For Low Height Credenzas or Benching Applications
- End Panel for 24" Deep Worksurfaces
- Required to Be Used with a Backpanel

LOW HEIGHT SUPPORT PANEL	65-1612SP	12	1 3/16	16 1/4	-	-	7	.4	\$ 239 CV\$ 275
--------------------------	-----------	----	--------	--------	---	---	---	----	--------------------

Description

- Required to be Used Perpendicular to Full Backpanels to Support Kneespace Areas of 60" or Longer

LOW HEIGHT SUPPORT T	65-1610SP	10	10	16 1/4	-	-	11	2.3	\$ 330 CV\$ 381
----------------------	-----------	----	----	--------	---	---	----	-----	--------------------

Description

- For Low Height Credenzas or Benching Applications
- Required to Be Used on Areas of 60" or Greater Where Backpanels are Not Used

For ordering options, see back of Gesso Identification card at the beginning of the section.

Item	Model No.	W	D	H	K	R	Ship Wt	Cubic Ft	List Price
MODULAR TABLE DESK LEG WITH LEVELER	01-0401MLA Aluminum Leg	2	2	28 3/4	-	-	10	.5	\$ 203
	01-0401MLB Black Leg	2	2	28 3/4	-	-	10	.5	\$ 203

Description

- Adjustable Black Leveler

MODULAR TABLE DESK LEG WITH CASTER	01-0400MLA Aluminum Leg	2	2	28 3/4	-	-	10	.5	\$ 174
	01-0400MLB Black Leg	2	2	28 3/4	-	-	10	.5	\$ 174



Description

- Locking Black Casters

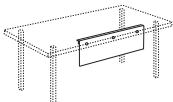
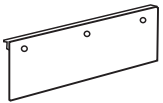
ACRYLIC PRIVACY PANEL OR MODESTY PANEL	65-1054PVS	54	1/4	10	-	-	24	1.2	\$ 504
	65-1042PVS	42	1/4	10	-	-	23	.9	\$ 434

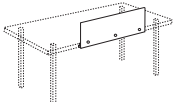

Modesty



Privacy

Description

- Install Downward for Modesty Panel
- Install Upward for Privacy Panel
- Attaches Below Worksurfaces
- Must Be Field Installed, Some Assembly Required

For ordering options, see back of Gesso Identification card at the beginning of the section.

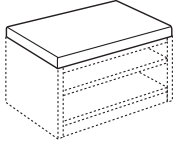
Item	Model No.	W	D	H	K	R	Ship Wt	Cubic Ft	List Price
	65-24108CUSHION	108	24	2 1/4	-	-	24	9.9	\$ 498
	65-2490CUSHION	90	24	2 1/4	-	-	22	8.3	\$ 451
	65-2472CUSHION	72	24	2 1/4	-	-	20	6.7	\$ 379
	65-2460CUSHION	60	24	2 1/4	-	-	18	5.6	\$ 329
	65-2436CUSHION	36	24	2 1/4	-	-	16	3.4	\$ 280
	65-2430CUSHION	30	24	2 1/4	-	-	14	2.9	\$ 242
	65-1519CUSHION	15	19	2 1/4	-	-	9	1.5	\$ 210

Description



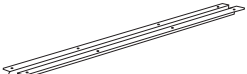

- Create Bench Style Seating Over Low Height Credenzas or Returns
- Must Attach to a Modular Top, See See Page 223
- Cushions are Shipped with Hardware for Both Fixed and Movable Applications
- Price is Valid for Fabric Grades 1, 2, and 3
- See Page 245 for Additional Fabric Grades

	01-00048SB	48	1 3/4	3/4	-	-	5	.3	\$ 163
	01-00060SB	60	1 3/4	3/4	-	-	8	.3	\$ 172

Description

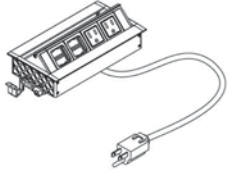
- Reinforces Worksurfaces with Large Kneespace Widths
- Recommended for Kneespace Areas 60" or Larger
- Field Installed

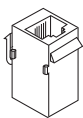
For ordering options, see back of Gesso Identification card at the beginning of the section.

Item	Model No.	W	D	H	K	R	Ship Wt	Cubic Ft	List Price	
POWER DATA PORT 	01-DPORT4A Aluminum	8	4	-	-	-	7	.2	\$ 690	
	01-DPORT4B Black	8	4	-	-	-	7	.2	\$ 690	
Description <ul style="list-style-type: none"> • Retracts into Work Surface to Regain Productive Space • One-Touch Access to Power and Data • Two Power Outlets and Two Open Ports for Data • Water-Proof Simplex (Outlets) • Includes a Voice/Data Adapter Kit to Accept Couplers and Jacks When Required • 6' Power Cord • Only Available on 30" & 36" TP's and Only on Center End, See Page 223 										
USB PORT 	01-USBPORT	-	-	-	-	-	-	-	\$ 102	
Description <ul style="list-style-type: none"> • Increases Transfer Speed Up to 5 gbs/sec • Simultaneous Read/Write Capability • Idle Device Power Saving State • 6' Cord 										
VOICE COUPLER 	01-VOICE1	-	-	-	-	-	-	-	\$ 46	
Description <ul style="list-style-type: none"> • 6-Pin Modular Plug • Molded Black • Cord Not Included 										
DATA PORT 	01-RJ4DATA	-	-	-	-	-	-	-	\$ 105	
Description <ul style="list-style-type: none"> • 8-Pin Modular Plug • Cat 5 Ethernet Cable • Pre-terminated Cable • 9' Cord 										

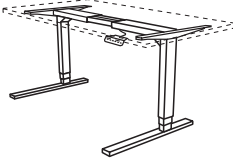
Item	Model No.	W	D	H	Ship Wt	Cubic Ft	List Price	
PNEUMATIC TABLE LIFT 	Silver	Black						
	01-2240PLS	01-2240PLB	36	22	26 - 45 1/2	66	2.3	\$ 3139
	Compatible with 24" Deep Tops that are 48" Long							
	01-2248PLS	01-2248PLB	44	22	26 - 45 1/2	68	2.3	\$ 3159
	Compatible with 24" Deep Tops that are 54" Long							
	01-2256PLS	01-2256PLB	52	22	26 - 45 1/2	70	2.5	\$ 3178
	Compatible with 24" Deep Tops that are 60" or 66" Long							
	01-2264PLS	01-2264PLB	60	22	26 - 45 1/2	71	2.8	\$ 3196
	Compatible with 24" Deep Tops that are 72" Long							
	01-2640PLS	01-2640PLB	36	22	26 - 45 1/2	66	2.3	\$ 3164
Compatible with 30" and 36" Deep Tops that are 48" Long								
01-2648PLS	01-2648PLB	44	22	26 - 45 1/2	68	2.3	\$ 3182	
Compatible with 30" and 36" Deep Tops that are 54" Long								
01-2656PLS	01-2656PLB	52	22	26 - 45 1/2	70	2.5	\$ 3200	
Compatible with 30" and 36" Deep Tops that are 60" or 66" Long								
01-2664PLS	01-2664PLB	60	22	26 - 45 1/2	71	2.8	\$ 3221	
Compatible with 30" and 36" Deep Tops that are 72" Long								

Description

- Pneumatic Lift Operates with Ease
- Stop at Any Position
- Height Adjustment from 26" to 46 1/2"
- Adjustable Levelers
- Tops Sold Separately
- Some Assembly Required
- Optional Grommets Must Be Field Installed

Item	Model No.	W	D	H	Ship Wt	Cubic Ft	List Price
ELECTRIC TABLE LIFT WITH CASTER 	Silver	Black					
	01-2861ELCS	01-2861ELCB	61 7/16	28 3/8	26 - 46 1/2	68	3
Compatible with 30" and 36" Deep Tops that are 72" - 84" Long							

Description

- Silver Table Lift
- Height Adjusts from 26" to 46 1/2" at 1" per Second
- Flip Out Tray Stores Cables Under the Desk Top
- Built In Casters Provide Mobility if Desired
- 176 lbs Maximum Load
- Tops Sold Separately
- Some Assembly Required
- Optional Battery Pack Available
- Optional Grommets Must Be Field Installed

Open Market Only

For ordering options, see back of Gesso Identification card at the beginning of the section.

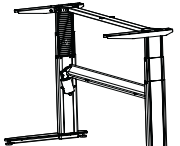
Item	Model No.	W	D	H	Ship Wt	Cubic Ft	List Price	
ELECTRIC TABLE LIFT  Open Market Only	Silver	Black						
	01-2232ELS	01-2232ELB	32 7/8	22 1/16	21 1/4 - 46 7/8	57	3.0	\$ 2074
	Compatible with 24" and 30" Deep Tops that are 42" - 48" Long							
	01-2256ELS	01-2256ELB	56 11/16	22 1/16	21 1/4 - 46 7/8	65	3.0	\$ 2139
Compatible with 24" and 30" Deep Tops that are 60" - 72" Long								
	01-2259ELS	01-2259ELB	59 13/16	22 1/16	21 1/4 - 46 7/8	66	3.0	\$ 2143
Compatible with 24" and 30" Deep Tops that are 72" - 84" Long								

Description

- Height Adjusts from 21 1/4" to 46 7/8" at 1.2" per Second
- 220 lbs Maximum Load
- Automatic Safety Stop
- Removable Top Bracket Allows Keyboard Installation
- Tops Sold Separately
- Some Assembly Required
- Optional Battery Pack Available
- Optional Grommets Must Be Field Installed

Options: Specify & Add

01-ELCASTERS	\$ 154
--------------	--------

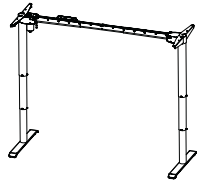
Item	Model No.	W	D	H	Ship Wt	Cubic Ft	List Price
ELECTRIC TABLE LIFT  Open Market Only	Silver	Black					
	01-2445ELS	01-2445ELB	69 5/16 - 45 11/16	27 1/2	24 3/4 - 48 7/16	53	3.0
Compatible with 24" and 30" Deep Tops that are 60" - 84" Long							

Description

- Width Adjusts from 45 11/16" to 69 5/16" in Intervals of 3 5/16"
- Height Adjusts from 24 3/4" to 48 7/16" at 1.2" per Second
- 220 lbs Maximum Load
- Silver or Black with Inner Columns in Chrome
- Tops Sold Separately
- Some Assembly Required
- Optional Battery Pack Available
- Optional Grommets Must Be Field Installed

BATTERY PACK	01-BATTERYKIT	-	-	-	1	.5	\$ 879
--------------	---------------	---	---	---	---	----	--------



Open Market Only

Description

- 24 Volt Battery with Charger
- Works with Select Electric Table Lifts As Noted On Lift

For ordering options, see back of Gesso Identification card at the beginning of the section.

Item	Model No.	W	D	H	K	R	Ship Wt	Cubic Ft	List Price
EXECUTIVE "L" UNIT	65-1	72	84	30	-	-	481	73.1	\$ 4602 CV\$ 5292

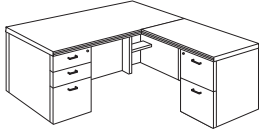
Consists of:
Qty

67-3672LPS	1	• Single Left Pedestal Desk	\$ 2886 CV\$ 3317
67-2448RF2	1	• Right Return	\$ 1716 CV\$ 1975

EXECUTIVE "U" UNIT BOW TOP DESK	65-2	177	96	70.81	-	-	1418	214.3	\$ 6273 CV\$ 7213
------------------------------------	------	-----	----	-------	---	---	------	-------	----------------------

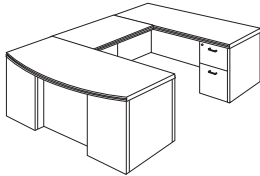
Consists of:
Qty

67-3672BLPS	1	• Single Pedestal Desk	\$ 3330 CV\$ 3829
65-2448UF	1	• Bridge	\$ 783 CV\$ 901
67-2472RC2	1	• Right Pedestal Credenza	\$ 2160 CV\$ 2483

For ordering options, see back of Gesso Identification card at the beginning of the section.

Item	Model No.	W	D	H	K	R	Ship Wt	Cubic Ft	List Price
EXECUTIVE CURVED "U" UNIT WITH SINGLE PED DESK	65-3	96	102	30	-	-	690	143.5	\$ 7845 CV\$ 9023

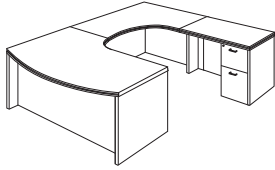

Consists of:	Qty		
67-4872CBLP	1	• Executive Curved Left Pedestal Desk	\$ 3567 CV\$ 4101
65-4854ECCR	1	• Extended Corner Unit Right	\$ 2562 CV\$ 2947
67-4824RF2	1	• Extended Return Right	\$ 1716 CV\$ 1975

EXECUTIVE OFFICE	65-5	144	72	70 7/8	-	-	1270	187.0	\$ 14267 CV\$ 16403
------------------	------	-----	----	--------	---	---	------	-------	------------------------

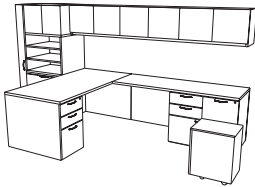

Consists of:	Qty		
67-3672LP	1	• Left Single Pedestal Desk	\$ 2640 CV\$ 3035
65-2472RMR	1	• Right Multi-File Return	\$ 3252 CV\$ 3739
65-3672WDS2	1	• Wardrobe/Storage Unit	\$ 3775 CV\$ 4340
65-15108WD	1	• Wall Mount Hutch	\$ 3228 CV\$ 3711
65-1519MP	1	• Mobile Pedestal	\$ 1372 CV\$ 1578

For ordering options, see back of Gesso Identification card at the beginning of the section.

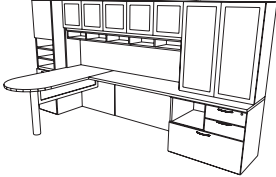
Item	Model No.	W	D	H	K	R	Ship Wt	Cubic Ft	List Price	
EXECUTIVE OFFICE	65-6	138	72	70 7/8	-	-	1018	165.2	\$ 15065 CV\$ 17163	
	Consists of:	Qty								
	65-3672DUL	1	• Left Peninsula Desk with Silver Frame Modesty							\$ 2605 CV\$ 2947
	65-2484TP	1	• Modular Top							\$ 700 CV\$ 806
	65-8428BP	1	• Modular Back Panel							\$ 583 CV\$ 671
	65-1584HU	1	• Surface Mount Hutch with Silver Framed Acrylic Doors							\$ 3099 CV\$ 3507
	65-1182PS	1	• Paperslots							\$ 1109 CV\$ 1276
	65-1536TUDB	1	• Top Unit Door Bookcase with Silver Framed Acrylic Doors							\$ 2117 CV\$ 2375
	65-2436OMF	1	• Modular Open Multi File							\$ 1841 CV\$ 2117
	65-1872DSIL	1	• Left Hinged Storage Cabinet File/File							\$ 2735 CV\$ 3147
	65-2812SP	1	• Support Panel							\$ 276 CV\$ 317

For ordering options, see back of Gesso Identification card at the beginning of the section.

Item	Model No.	W	D	H	K	R	Ship Wt	Cubic Ft	List Price	
EXECUTIVE WORKSTATION	65-7	72	102	30	-	-	690	143.5	\$ 14999 CV\$ 17174	
	Consists of:	Qty								
	65-3672TP	1	• Modular Desk Top							\$ 810 CV\$ 931
	65-1811USP	1	• Desk Support Over Low Height Credenza							\$ 371 CV\$ 427
	65-24108TP	1	• Modular Credenza Top							\$ 819 CV\$ 943
	65-2436TP	1	• Modular Credenza Top							\$ 414 CV\$ 476
	65-2436LTF	2	• Low Modular Storage							\$ 2638 CV\$ 3038
	65-2436LDB	1	• Low Modular Door Bookcase							\$ 1236 CV\$ 1421
	65-2436LBC	1	• Low Modular Bookcase							\$ 1085 CV\$ 1247
	65-10816BP	1	• Low Modular Back Panel							\$ 564 CV\$ 648
	65-3616BP	1	• Low Modular Back Panel							\$ 298 CV\$ 343
	65-15108SHU	1	• Surface Mounted Hutch with Sliding Doors							\$ 4161 CV\$ 4785
	65-1518HB	1	• Open Bookcase Tower							\$ 907 CV\$ 1041
	65-1518HR3	1	• Right Hinged Door Bookcase Tower							\$ 1194 CV\$ 1372
	01-2428HLV	1	• Metal Peninsula Support							\$ 502

For ordering options, see back of Gesso Identification card at the beginning of the section.

TACKBOARD: SURFACE MOUNTED HUTCHES - 23" TALL

Size	Model #	COM ydg	COM, Grade 1, 2 or 3 List Price	Grade 4 List Price	Grade 5 List Price	Grade 6 List Price	Grade 7 List Price	Grade 8 List Price	Grade 9 List Price	Grade 10 List Price
66"	TB-6566H	2.00	\$ 336	\$ 518	\$ 600	\$ 690	\$ 810	\$ 937	\$ 1090	\$ 1263
72"	TB-6572H	2.25	\$ 357	\$ 561	\$ 653	\$ 755	\$ 890	\$ 1033	\$ 1204	\$ 1399
78"	TB-6578H	2.50	\$ 397	\$ 624	\$ 726	\$ 840	\$ 989	\$ 1148	\$ 1339	\$ 1555
84"	TB-6584H	2.50	\$ 404	\$ 631	\$ 734	\$ 847	\$ 996	\$ 1156	\$ 1346	\$ 1562
90"	TB-6590H	2.75	\$ 425	\$ 674	\$ 787	\$ 912	\$ 1076	\$ 1251	\$ 1461	\$ 1698
96"	TB-6596H	3.00	\$ 446	\$ 717	\$ 841	\$ 977	\$ 1156	\$ 1347	\$ 1575	\$ 1835
102"	TB-65102H	3.25	\$ 461	\$ 755	\$ 889	\$ 1036	\$ 1230	\$ 1438	\$ 1685	\$ 1966
108"	TB-65108H	3.50	\$ 478	\$ 795	\$ 939	\$ 1098	\$ 1307	\$ 1530	\$ 1797	\$ 2099

NOTE: All tackboards 78" and longer are 2 pieces.

TACKBOARD: WALL MOUNTED HUTCHES - 23" TALL

Size	Model #	COM ydg	COM, Grade 1, 2 or 3 List Price	Grade 4 List Price	Grade 5 List Price	Grade 6 List Price	Grade 7 List Price	Grade 8 List Price	Grade 9 List Price	Grade 10 List Price
30"	TB-6530W	1.00	\$ 247	\$ 338	\$ 379	\$ 424	\$ 484	\$ 547	\$ 624	\$ 710
36"	TB-6536W	1.25	\$ 274	\$ 387	\$ 438	\$ 495	\$ 570	\$ 649	\$ 744	\$ 853
42"	TB-6542W	1.25	\$ 281	\$ 394	\$ 446	\$ 502	\$ 577	\$ 657	\$ 752	\$ 860
48"	TB-6548W	1.50	\$ 311	\$ 447	\$ 508	\$ 576	\$ 666	\$ 761	\$ 876	\$ 1005
54"	TB-6554W	1.75	\$ 340	\$ 498	\$ 570	\$ 649	\$ 754	\$ 865	\$ 999	\$ 1150
60"	TB-6560W	2.00	\$ 357	\$ 538	\$ 620	\$ 711	\$ 830	\$ 958	\$ 1110	\$ 1283
66"	TB-6566W	2.00	\$ 383	\$ 564	\$ 646	\$ 737	\$ 856	\$ 984	\$ 1136	\$ 1309
72"	TB-6572W	2.25	\$ 405	\$ 609	\$ 702	\$ 804	\$ 938	\$ 1081	\$ 1253	\$ 1447
78"	TB-6578W	2.50	\$ 439	\$ 666	\$ 769	\$ 882	\$ 1031	\$ 1191	\$ 1381	\$ 1597
84"	TB-6584W	2.50	\$ 449	\$ 675	\$ 778	\$ 891	\$ 1040	\$ 1200	\$ 1390	\$ 1606
90"	TB-6590W	2.75	\$ 474	\$ 723	\$ 837	\$ 961	\$ 1125	\$ 1301	\$ 1510	\$ 1748
96"	TB-6596W	3.00	\$ 496	\$ 768	\$ 891	\$ 1027	\$ 1206	\$ 1397	\$ 1626	\$ 1885
102"	TB-65102W	3.25	\$ 508	\$ 803	\$ 936	\$ 1084	\$ 1278	\$ 1485	\$ 1732	\$ 2013
108"	TB-65108W	3.50	\$ 532	\$ 849	\$ 993	\$ 1151	\$ 1360	\$ 1584	\$ 1850	\$ 2153

NOTE: All tackboards 78" and longer are 2 pieces.

TASKLIGHTS - Includes 3 Wire Management Grommets

Model #	Size	Description	List Price
TL-0824	22 1/2" x 1 5/8" x 7/8"	84-LED, 7 Watts	\$ 234
TL-0848	47 1/2" x 1 5/8" x 7/8"	240-LED, 18 Watts	\$ 280
01-47LED17	16 13/32" x 2" x 1/2"	47-LED, 10.9 Watts	\$ 436
01-94LED31	30 1/8" x 2" x 1/2"	94-LED, 23.4 Watts	\$ 755
01-188LED58	57 13/32" x 2" x 1/2"	188-LED, 43.5 Watts	\$ 1043
01-OSRP	2 5/16" x 2" x 1/2"	Occupancy Sensor	\$ 232

- All LED Lights Include the Power Supply
- Optional Occupancy Sensor Shuts Off After 30 Minutes of Inactivity and Turns on Immediately When Reentering the Detection Area. Does Not Apply to TL Models.

TALL TACKBOARDS - for Wall Mount Hutches Over Low Height Credenzas or Benches - 35" TALL

Size	Model #	COM ydg	COM, Grade 1, 2 or 3 List Price	Grade 4 List Price	Grade 5 List Price	Grade 6 List Price	Grade 7 List Price	Grade 8 List Price	Grade 9 List Price	Grade 10 List Price
30"	TB-6530TW	1.00	\$ 324	\$ 415	\$ 456	\$ 501	\$ 561	\$ 625	\$ 701	\$ 787
36"	TB-6536TW	1.25	\$ 360	\$ 473	\$ 525	\$ 581	\$ 656	\$ 736	\$ 831	\$ 939
42"	TB-6542TW	1.25	\$ 369	\$ 483	\$ 534	\$ 591	\$ 665	\$ 745	\$ 840	\$ 948
48"	TB-6548TW	1.50	\$ 410	\$ 545	\$ 607	\$ 675	\$ 765	\$ 860	\$ 974	\$ 1104
54"	TB-6554TW	1.75	\$ 451	\$ 609	\$ 681	\$ 760	\$ 865	\$ 977	\$ 1110	\$ 1261
60"	TB-6560TW	2.00	\$ 474	\$ 655	\$ 738	\$ 828	\$ 948	\$ 1075	\$ 1228	\$ 1400
66"	TB-6566TW	2.00	\$ 506	\$ 687	\$ 770	\$ 860	\$ 980	\$ 1107	\$ 1259	\$ 1432
72"	TB-6572TW	2.25	\$ 527	\$ 731	\$ 823	\$ 925	\$ 1059	\$ 1203	\$ 1374	\$ 1569
78"	TB-6578TW	2.50	\$ 571	\$ 797	\$ 900	\$ 1014	\$ 1163	\$ 1322	\$ 1513	\$ 1729
84"	TB-6584TW	2.50	\$ 583	\$ 810	\$ 913	\$ 1026	\$ 1175	\$ 1335	\$ 1525	\$ 1741
90"	TB-6590TW	2.75	\$ 615	\$ 864	\$ 978	\$ 1102	\$ 1266	\$ 1442	\$ 1651	\$ 1889
96"	TB-6596TW	3.00	\$ 644	\$ 916	\$ 1039	\$ 1175	\$ 1354	\$ 1546	\$ 1774	\$ 2033
102"	TB-65102TW	3.25	\$ 664	\$ 958	\$ 1092	\$ 1239	\$ 1433	\$ 1640	\$ 1888	\$ 2169
108"	TB-65108TW	3.50	\$ 693	\$ 1009	\$ 1154	\$ 1312	\$ 1521	\$ 1744	\$ 2011	\$ 2313

CUSHIONS - 2" Thick

Model #	COM ydg	COM, Grade 1, 2 or 3 List Price	Grade 4 List Price	Grade 5 List Price	Grade 6 List Price	Grade 7 List Price	Grade 8 List Price	Grade 9 List Price	Grade 10 List Price	Grade L1 List Price	Grade L2 List Price
65-1519CUSHION	0.75	\$ 210	\$ 278	\$ 309	\$ 343	\$ 387	\$ 435	\$ 492	\$ 557	\$ 374	\$ 445
65-2430CUSHION	1.25	\$ 242	\$ 332	\$ 374	\$ 419	\$ 478	\$ 542	\$ 618	\$ 705	\$ 460	\$ 656
65-2436CUSHION	1.25	\$ 280	\$ 393	\$ 445	\$ 501	\$ 576	\$ 655	\$ 751	\$ 859	\$ 553	\$ 672
65-2460CUSHION	2.00	\$ 329	\$ 510	\$ 593	\$ 683	\$ 803	\$ 930	\$ 1083	\$ 1255	\$ 766	\$ 957
65-2472CUSHION	2.25	\$ 379	\$ 582	\$ 675	\$ 777	\$ 911	\$ 1055	\$ 1226	\$ 1421	\$ 870	\$ 1085
65-2490CUSHION	2.75	\$ 451	\$ 700	\$ 813	\$ 937	\$ 1102	\$ 1277	\$ 1486	\$ 1724	\$ 1051	\$ 1314
65-24108CUSHION	3.25	\$ 498	\$ 792	\$ 926	\$ 1073	\$ 1267	\$ 1475	\$ 1722	\$ 2003	\$ 1207	\$ 1518

Madera™

Casegoods Collection

How to Order

MODEL NO.	DESCRIPTION	
16-4272DPS	Finish	BC
	Top Surface	W
	Veneer	PV
	Edge	X
	Pull	MBW

All options must be labeled and specified.



Specifications



VENEER

Choose from premium veneer or select veneer on exposed surfaces in American Black Walnut, White Oak, Cherry, or Maple species. The American Black Walnut, White Oak, and Cherry veneers are Book Matched veneer faces, while the Maple is a Slip-Matched veneer face. These veneers are carefully selected and matched to assure proper balance and consistency.

TOPS

The wood veneer tops are available in the 6 Madera edge details, which each determine the style of construction. The “D”, “E”, “X”, and “Y” have vertical profiles, which have a 5-ply balanced construction, 1 $\frac{3}{16}$ " thick with hardwood rims. The “A” & “B” profiles have the same construction, but provide a matching reverse shape on adjoining units. The high pressure laminate tops have a 3-ply balanced construction, 1 $\frac{3}{16}$ " thick with solid hardwood rims. Grain direction runs left to right unless otherwise noted.

CHASSIS CONSTRUCTION

Tops, end panels, and modesty panels are securely fastened using high quality European style fastening systems and heavy-duty, 16-gauge joining brackets to assure maximum strength. All units are equipped with heavy-duty, adjustable glides to ensure proper leveling and compensation for uneven floors.

DRAWERS

All drawer fronts are standard with elegant veneer faces. Fronts are a 3-ply construction $\frac{3}{4}$ " thick, and vertically matched in sets. Drawer interiors are dovetail construction with $\frac{7}{16}$ " thick hardwood sides and backs and $\frac{5}{32}$ " thick hardboard bottoms. The drawer interiors are sanded, sealed, and finished to provide a smooth, quality feel and appearance. Drawer fronts feature multiple pull options and pull finishes which include a concealed finger pull, a waterfall shaped face-mounted pull, and an arched face-mounted pull. 5-sided drawer construction allows for easy removal of drawer fronts.

DRAWER SUSPENSION

File drawers have high quality, progressive full extension slides with precision steel ball bearings to ensure a smooth, quiet operation. Box drawers are equipped with full extension ball bearing action slides with a positive stop action. All suspensions have a lifetime warranty.

FILING HARDWARE

All file drawers are standard with custom fitted filing systems designed to accommodate a variety of filing requirements. Legal width file drawers provide legal filing front to back, and letter or legal filing side to side. Letter width file drawers provide letter filing front to back, and letter or legal filing side to side.

LOCKING

All desks, credenzas, and lateral files feature locking. Removable lock cylinders allow for units to be re-keyed at a later date if required. Units are shipped randomly keyed as standard. Lock cores match pull color.

CORD MANAGEMENT

Route power and data cables away from the worksurface through inherent grommet placement. Optional black grommets are standard in back panels of assembled returns, bridge units, kneespace credenzas, and hutch units. A grommet is standard in tops of corner units. Grommets may be ordered in the tops of desks, returns, bridge units, credenzas, and component work-surfaces. See page 253 for all optional grommet locations.

Undersurface tracks are available for additional cord management. Silver grommets are also available. See Accessories.

FINISH

Madera features Ultra-Violet matte finish on all exposed surfaces by utilizing roll-coat UV technology. Our durable UVAdvantage® finish makes surfaces less likely to be damaged by abrasions, scratches, water, alcohol, stains, and common chemicals. Our UVAdvantage® finish magnifies the beauty of our wood finishes and reduces the darkening, aging, and yellowing process of wood furniture that naturally occurs over time. Once cured by UV lighting, our UVAdvantage® finish does not emit irritable toxins, formaldehyde, or solvents into the air creating a safe work environment within new furniture installations. This process has allowed us to achieve third party certification for Indoor Air Quality. Additionally our UVAdvantage® finish greatly reduces hazardous air pollutants which contribute to smog formation, and our UVAdvantage® finish is recaptured over and over again reducing waste materials. Automated production technology eliminates exposure to sprayed chemicals in our factories. High gloss UVAdvantage® finish available on request.

Options Galore

Finish Options

WOOD VENEER (W) OR LAMINATE (P) TOPS – MUST SPECIFY



Available in High Pressure Laminate Tops. **(P)**

Note: All finishes are available with Premium Veneers. Must specify **(PV)** with finish and top codes.

Edge Options

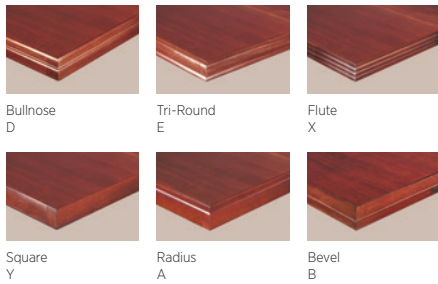

Pull Options



COORDINATING PRODUCTS

Madera Caseloads offers options to coordinate with Aura Conference and Aura Reception.

INTERIOR DRAWER DIMENSIONS

MADERA 1400 INTERIOR DRAWER DIMENSIONS

Item	Drawers	W	L	D
14-4272DP	Box	15 ¹¹ / ₃₂	19 ³ / ₈	3 ²¹ / ₃₂
14-3672DP	File	15 ¹¹ / ₃₂	19 ³ / ₈	8 ²⁹ / ₃₂
14-3672LP/RP				
14-3072DP				
14-3072LP/RP				
14-3066DP	Box	12 ¹¹ / ₃₂	19 ³ / ₈	3 ²¹ / ₃₂
14-3060DP	File	12 ¹¹ / ₃₂	19 ³ / ₈	8 ²⁹ / ₃₂
14-3066LP/RP				
14-1619MP1	Box	12 ¹¹ / ₃₂	16 ¹ / ₄	3 ²¹ / ₃₂
14-2448LF/RF	File	12 ¹¹ / ₃₂	16 ¹ / ₄	8 ²⁹ / ₃₂
14-2442LF/RF				
14-2072SC	Box	15 ¹¹ / ₃₂	16 ¹ / ₄	3 ²¹ / ₃₂
14-2072KC	File	15 ¹¹ / ₃₂	16 ¹ / ₄	8 ²⁹ / ₃₂
14-2072LC/RC				
14-2066KC	Box	12 ¹¹ / ₃₂	16 ¹ / ₄	3 ²¹ / ₃₂
14-2066LC/RC	File	12 ¹¹ / ₃₂	16 ¹ / ₄	8 ²⁹ / ₃₂
14-2472LL3/LL3H	Lateral	25 ³ / ₄	19 ³ / ₈	8 ²⁹ / ₃₂
14-2472RL3/RL3H				
14-2466LL3/LL3H				
14-2466RL3/RL3H				
14-2430L2/L3/L4				
14-2472LL/LLH	Lateral	31 ³ / ₄	16 ¹ / ₄	8 ²⁹ / ₃₂
14-2472RL/RLH				
14-2472DL				
14-2466LL/LLH				
14-2466RL/RLH				
14-2436L2/L3/L4				
14-2036L2/L4				
14-2072LL/LL4				
14-2072RL/RL4				
14-2072DL				
14-2418PD1	Box	14 ⁹ / ₃₂	16 ¹ / ₄	3 ²¹ / ₃₂
	File	14 ⁹ / ₃₂	16 ¹ / ₄	8 ²⁹ / ₃₂
14-3018PD1	Box	14 ⁹ / ₃₂	19 ³ / ₈	3 ²¹ / ₃₂
14-3618PD1	File	14 ⁹ / ₃₂	19 ³ / ₈	8 ²⁹ / ₃₂
14-2418PD2	File	14 ⁹ / ₃₂	16 ¹ / ₄	8 ²⁹ / ₃₂
14-3018PD2	File	14 ⁹ / ₃₂	16 ¹ / ₄	8 ²⁹ / ₃₂
14-3618PD2				
14-2436LF2	Box	15 ⁵ / ₁₆	16 ¹ / ₄	3 ²¹ / ₃₂
	File	14 ¹ / ₂	16 ¹ / ₄	8 ²⁹ / ₃₂
	Lateral	32 ⁹ / ₁₆	16 ¹ / ₄	8 ²⁹ / ₃₂
14-2430LF2	Box	11 ¹ / ₂	16 ¹ / ₄	3 ²¹ / ₃₂
	File	12 ¹¹ / ₃₂	16 ¹ / ₄	8 ²⁹ / ₃₂
	Lateral	26 ⁹ / ₁₆	16 ¹ / ₄	8 ²⁹ / ₃₂
14-2036MF	Box	13 ²³ / ₃₂	16 ¹ / ₄	3 ²¹ / ₃₂
	File	15 ¹¹ / ₃₂	16 ¹ / ₄	8 ²⁹ / ₃₂
	Lateral	31 ³ / ₄	16 ¹ / ₄	8 ²⁹ / ₃₂
14-2436LF1	Lateral	32 ⁹ / ₁₆	16 ¹ / ₄	8 ²⁹ / ₃₂
14-2430LF1	Lateral	26 ⁹ / ₁₆	16 ¹ / ₄	8 ²⁹ / ₃₂

FILING CAPABILITIES

 15 ¹¹/₃₂ x 19 ³/₈

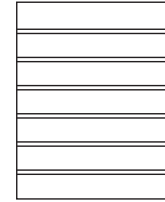
 14 ⁹/₃₂ x 19 ³/₈

Legal Front to Back

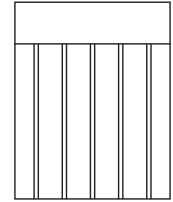

Legal Side to Side

 12 ¹¹/₃₂ x 19 ³/₈

Letter Front to Back

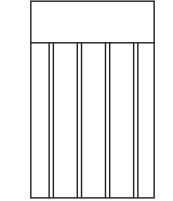

Legal Side to Side

 16 ¹/₈ x 16 ¹/₄

 14 ¹/₂ x 16 ¹/₄

 14 ⁹/₃₂ x 16 ¹/₄

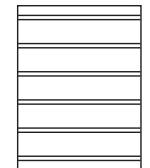
 12 ¹¹/₃₂ x 16 ¹/₄

Letter Front to Back

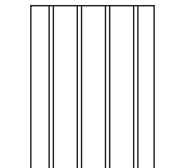

Legal Side to Side

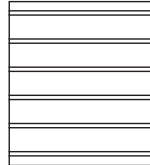
 15 ¹¹/₃₂ x 16 ¹/₄

Legal Front to Back

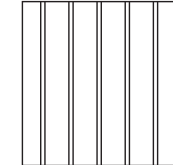

Legal Side to Side

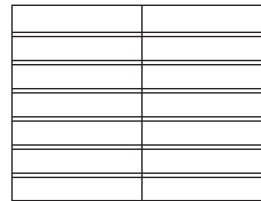
 25 ³/₄ x 19 ³/₈

2 Rows Letter Front to Back

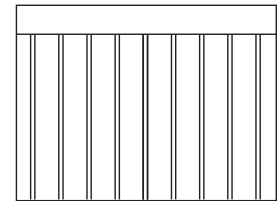

1 Row Letter or Legal Side to Side

 32 ⁹/₁₆ x 16 ¹/₄

 31 ³/₄ x 16 ¹/₄

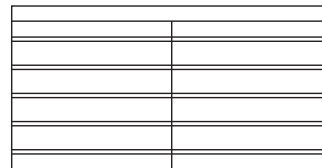
 26 ⁹/₁₆ x 16 ¹/₄

2 Rows Letter or Legal Front to Back

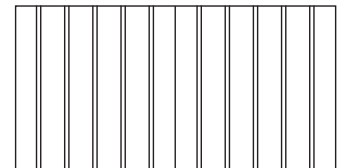

1 Row Letter or Legal Side to Side

INTERIOR DRAWER DIMENSIONS - CONTINUED

MADERA 1600 INTERIOR DRAWER DIMENSIONS

Item	Drawers	W	L	D
16-4272DP	Box	15 11/32	19 3/8	3 21/32
16-4272DPS	File	15 11/32	19 3/8	8 29/32
16-4272DPSO				
16-4272LP/LPS				
16-4272LPSO				
16-4272RP/RPS				
16-4272RPSO				
16-3672DP				
16-3672DPS				
16-3672DPSO				
16-3672LP/LPS				
16-3672LPSO				
16-3672RP/RPS				
16-3672RPSO				
16-3072DP				
16-3072LP				
16-3072LPS				
16-3072LPSO				
16-3072RP				
16-3072RPS				
16-3072RPSO				
16-3066DP	Box	12 11/32	19 3/8	3 21/32
16-3066LP	File	12 11/32	19 3/8	8 29/32
16-3066LPS				
16-3066LPSO				
16-3066RP				
16-3066RPS				
16-3066RPSO				
16-3060DP				
16-2448LF/LF2	Box	12 11/32	16 1/4	3 21/32
16-2448LFH/LF2H	File	12 11/32	16 1/4	8 29/32
16-2448RF/RF2				
16-2448RFH/RF2H				
16-2442LF/LF2				
16-2442LFH/LF2H				
16-2442RF/RF2				
16-2442RFH/RF2H				
16-2472KC/KCH	File	15 11/32	16 1/4	8 29/32
16-2472SC				
16-2072KC				
16-2072SC				
16-2472LC/LC2	Box	15 11/32	16 1/4	3 21/32
16-2472LCH/LC2H	File	15 11/32	16 1/4	8 29/32
16-2472RC/RC2				
16-2472RCH/RC2H				
16-2072LC/LC2				
16-2072RC/RC2				
16-2466KC/KCH	Box	12 11/32	16 1/4	3 21/32
16-2466LC/LC2	File	12 11/32	16 1/4	8 29/32
16-2466LCH/LC2H				
16-2466RC/RC2				
16-2466RCH/RC2H				
16-2066KC				
16-2066LC/LC2				
16-2066RC/RC2				

FILING CAPABILITIES - CONTINUED

15 11/32 x 19 3/8

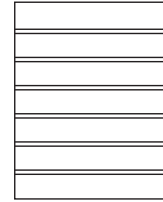

Legal Front to Back

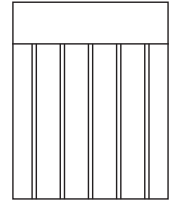

Legal Side to Side

12 11/32 x 19 3/8

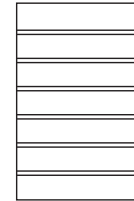

Letter Front to Back

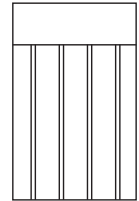

Legal Side to Side

12 11/32 x 16 1/4

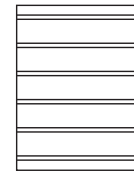

Letter Front to Back

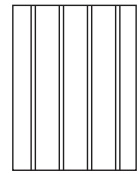

Legal Side to Side

15 11/32 x 16 1/4

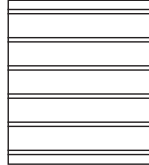

Legal Front to Back

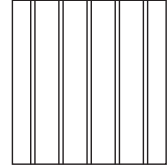

Legal Side to Side

GROMMET LOCATIONS

Grommets are standard in the back panels of returns, bridges, and credenzas. These units may be ordered without grommets at no additional charge. Please specify "NO GROMMET" on order.

Grommets are available on hutches in standard locations for tasklight management at no additional charge. Please specify HUGRMT.

Desk grommets are available in standard locations. Please specify and add an upcharge of \$48 list for each grommet.

Specify grommet locations.

- GL - Grommet Left
- GC - Grommet Center
- GR - Grommet Right

Example: 14-3672LP-GL-GR (Grommet Left, Grommet Right)

Grommets may be ordered in non-standard locations. Please call Customer Service to assist with how to order and additional lead time requirements.

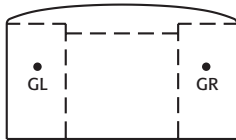

16-4272DPS	16-4272RPSO
16-4272DPSO	16-3672DPS
16-4272LPS	16-3672LPS
16-4272LPSO	16-3672RPS
16-4272RPS	

GL/GR - 6" from ends, 22 1/2" from user side.

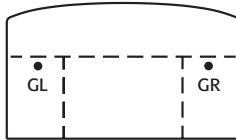

16-4272DP
16-4272LP
16-4272RP
14-4272DP
14-4272LP
14-4272RP

GL/GR - 6" from ends, 22 1/2" from user side.

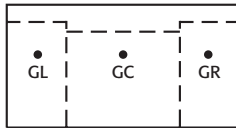

16-3672DPSO
16-3672LPSO
16-3672RPSO

GL/GR - 6" from ends, 22 1/2" from user side.
 GC - 22 1/2" from user side.

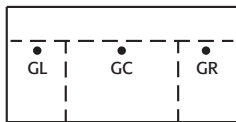

16-3672DP	14-3672DP
16-3672LP	14-3672LP
16-3672RP	14-3672RP

GL/GR - 6" from ends, 22 1/2" from user side.
 GC - 22 1/2" from user side.

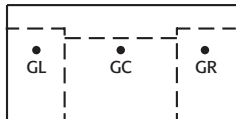

16-3072LPSO
16-3072RPSO
16-3066LPSO
16-3066RPSO

GL/GR - 6" from ends, 17" from user side.
 GC - 17" from user side.

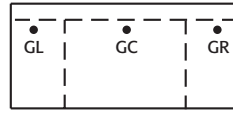
GROMMET LOCATIONS - CONTINUED

16-3066DP	16-3072DP
16-3066LP	16-3072LP
16-3066RP	16-3072RP
14-3066DP	14-3072DP
14-3066LP	14-3072LP
14-3066RP	14-3072RP

GL/GR - 6" from ends, 22 1/2" from user side.
 GC - 22 1/2" from user side.

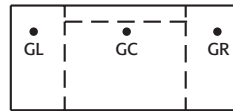

16-3072LPS
16-3072RPS
16-3066LPS
16-3066RPS

GL/GR - 6" from ends, 22 1/2" from user side.
 GC - 22 1/2" from user side.

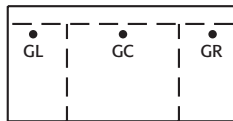

16-3060DP
14-3060DP

GL/GR - 6" from ends, 22 1/2" from user side.
 GC - 22 1/2" from user side.



14-2448UF/UFH
14-2442UF/UFH
14-2436UF/UFH

GL/GR - 6" from ends, 20" from user side.
 GC - 20" from user side.

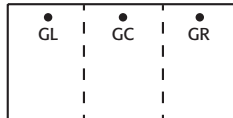

16-2448LF/LF2	16-2442LF/LF2
16-2448LFH/LF2H	16-2442LFH/LF2H
16-2448RF/RF2	16-2442RF/RF2
16-2448RFH/RF2H	16-2442RFH/RF2H
14-2448LF	14-2442LF
14-2448RF	14-2442RF
14-2472LMR	14-2472RMR

GL/GR - 6" from ends, 20" from user side.
 GC - 20" from user side.

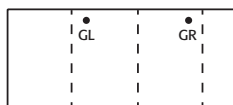

16-2072KC	14-2072LC
14-2072KC	14-2072RC
16-2072LC/LC2	14-2072RL/RL4
16-2072RC/RC2	14-2072LL/LL4

GL/GR - 22 1/2" from ends, 17" from user side.



16-2472KC/KCH
16-2472LC/LC2
16-2472RC/RC2
16-2472LCH/LC2H
16-2472RCH/RC2H

GL/GR - 22 1/2" from ends, 20" from user side.



16-2066KC	14-2066KC
16-2066LC/LC2	14-2066LC
16-2066RC/RC2	14-2066RC

GL/GR - 19 1/2" from ends, 17" from user side.

GROMMET LOCATIONS - CONTINUED



16-2466KC/KCH
 16-2466LC/LC2
 16-2466RC/RC2
 16-2466LCH/LC2H
 16-2466RCH/RC2H

GL/GR - 19 1/2" from ends, 20" from user side.

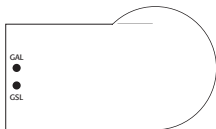

14-2472LL/LL3
 14-2472RL/RL3
 14-2472LLH/LL3H
 14-2472RLH/RL3H
 14-2466LL/LL3
 14-2466RL/RL3
 14-2466LLH/LL3H
 14-2466RLH/RL3H

GL/GR - 22 1/2" from ends, 20" from user side.



14-4272PR

GAL/GSL - 12" from approach or seated side, 6" from end.

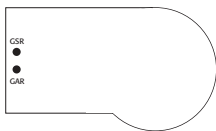

14-4272PL

GSR/GAR - 12" from approach or seated side, 6" from end.



14-3672DUR
 14-3072DUR



14-3672DUL
 14-3072DUL

GAL/GSL - 12" from approach or seated side, 6" from end.
 GAR/GSR - 12" from approach or seated side, 6" from end.

LOCKING HUTCH DOORS

Locking doors are available on hutches.

Size	=	List Upcharge
36"	=	\$58.00
66" - 78"	=	\$71.00
84" - 96"	=	\$85.00

PULL-OUT WRITING SHELVES

Pull-out writing shelves are available on desks.
 Please specify and add \$150 for any double pedestal desks.
 Please specify and add \$75 for any single pedestal desks.

Item	Model No.	W	D	H	K	R	Ship Wt	Cubic Ft	List Price
EXECUTIVE DOUBLE FULL PED DESK BOW TOP	16-4272DPS Stepped Front	72	42-36	30	34 5/16	-	326	58.4	W/P \$ 4775 PV \$ 5586
	16-4272DP Recessed Front	72	42-36	30	33 1/2	15 7/8-9 7/8	326	58.4	W/P \$ 4368 PV \$ 5110

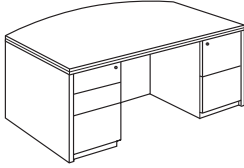
Description

- Bow Top
- Legal Width Locking Pedestals
- Box/Box/File in Left Pedestal
- File/File in Right Pedestal
- Black Utility Tray for Box Drawer

EXECUTIVE DOUBLE FULL PED DESK BOW TOP OVERHANG	16-4272DPSO Stepped Front	72	42-36	30	34 5/16	12-6	310	58.4	W/P \$ 4685 PV \$ 5481
---	------------------------------	----	-------	----	---------	------	-----	------	---------------------------

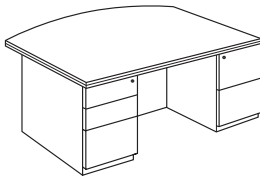
Description

- Bow Top
- Legal Width Locking Pedestals
- Box/Box/File in Left Pedestal
- File/File in Right Pedestal
- Black Utility Tray for Box Drawer

EXECUTIVE DOUBLE FULL PED DESK RECTANGULAR TOP	16-3672DPS Stepped Front - Legal Pedestal	72	36	30	34 5/16	-	400	51.9	W/P \$ 4121 PV \$ 4821
	16-3672DP Recessed Front - Legal Pedestal	72	36	30	34 5/16	-	425	51.9	W/P \$ 3741 PV \$ 4377
	16-3072DP Recessed Front - Legal Pedestal	72	30	30	28 5/16	-	410	43.9	W/P \$ 3699 PV \$ 4328
	16-3066DP Recessed Front - Letter Pedestal	66	30	30	-	-	277	40.4	W/P \$ 3489 PV \$ 4082
	16-3060DP Recessed Front - Letter Pedestal	60	30	30	-	-	259	36.9	W/P \$ 3314 PV \$ 3877

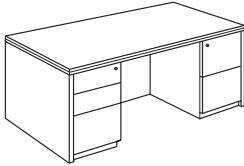

Description

- Rectangular Top
- Locking Pedestals
- Box/Box/File in Left Pedestal
- File/File in Right Pedestal
- Black Utility Tray for Box Drawer

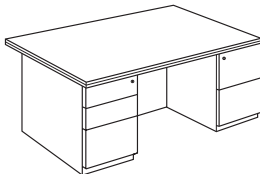
EXECUTIVE DOUBLE FULL PED DESK RECTANGULAR TOP OVERHANG	16-3672DPSO Stepped Front	72	36	30	34 5/16	6	385	51.9	W/P \$ 4035 PV \$ 4720
---	------------------------------	----	----	----	---------	---	-----	------	---------------------------

Description

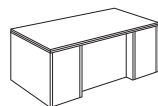
- Rectangular Top
- Legal Width Locking Pedestals
- Box/Box/File in Left Pedestal
- File/File in Right Pedestal
- Black Utility Tray for Box Drawer



Stepped Front

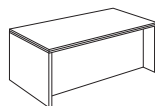

Recessed Front

For ordering options, see back of Madera Identification card at the beginning of section.

For grommet options, see page 254.

For center drawer options, see page 273.

Item	Model No.	W	D	H	K	R	Ship Wt	Cubic Ft	List Price
EXECUTIVE DOUBLE 3/4 PED DESK BOW TOP	14-4272DP	72	42-36	30	33 1/2	15 7/8-9 7/8	318	60.1	W/P \$ 4089
	Recessed Front								PV \$ 4784

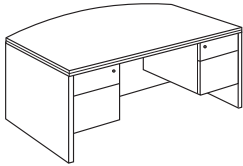
Description

- Bow Top
- Legal Width Locking Pedestals
- Box/File in Both Pedestals
- Black Utility Tray for Box Drawer

EXECUTIVE DOUBLE 3/4 PED DESK RECTANGULAR TOP	14-3672DP	72	36	30	34 5/16	-	295	51.9	W/P \$ 3267
	Recessed Front - Legal Pedestal								PV \$ 3824
	14-3072DP	72	30	30	28 5/16	-	264	43.9	W/P \$ 3173
	Recessed Front - Legal Pedestal								PV \$ 3714
	14-3066DP	66	30	30	-	-	251	40.4	W/P \$ 2965
	Recessed Front - Letter Pedestal								PV \$ 3469
	14-3060DP	60	30	30	-	-	228	35.3	W/P \$ 2792
	Recessed Front - Letter Pedestal								PV \$ 3266

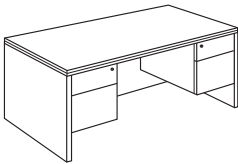
Description

- Rectangular Top
- Locking Pedestals
- Box/File in Both Pedestals
- Black Utility Tray for Box Drawer

EXECUTIVE SINGLE FULL PED DESK BOW TOP	Left Ped	Right Ped	W	D	H	K	R	Ship Wt	Cubic Ft	List Price
		16-4272LPS	16-4272RPS	72	42-36	30	-	-	286	60.1
	Stepped Front									PV \$ 4875
	16-4272LP	16-4272RP	72	42-36	30	-	-	286	60.1	W/P \$ 3669
	Recessed Front									PV \$ 4293

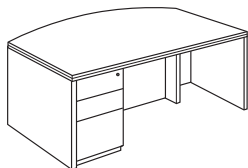

Description

- Bow Top
- Legal Width Locking Pedestal
- Box/Box/File in Pedestal
- Black Utility Tray for Box Drawer

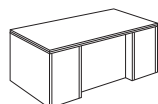
All pedestal desks shown as left.

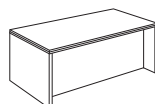

Stepped Front



Recessed Front

For ordering options, see back of Madera Identification card at the beginning of section.

For grommet options, see page 254.

For center drawer options, see page 273.

Item	Model No.	W	D	H	K	R	Ship Wt	Cubic Ft	List Price
EXECUTIVE SINGLE FULL PED DESK BOW TOP OVERHANG	Left Ped	Right Ped							
	16-4272LPSO Stepped Front	16-4272RPSO	72	42-36	30	-	12-6	270	58.4

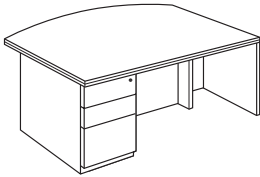

Description

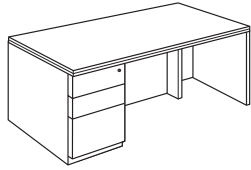
- Bow Top
- Legal Width Locking Pedestal
- Box/Box/File in Pedestal
- Black Utility Tray for Box Drawer

EXECUTIVE SINGLE FULL PED DESK RECTANGULAR TOP	Left Ped	Right Ped	W	D	H	K	R	Ship Wt	Cubic Ft	List Price
		16-3672LPS Stepped Front - Legal Pedestal	16-3672RPS	72	36	30	-	-	267	51.9
16-3672LP Recessed Front - Legal Pedestal		16-3672RP	72	36	30	-	-	267	51.9	W/P \$ 3116 PV \$ 3645
16-3072LPS Stepped Front - Legal Pedestal		16-3072RPS	72	30	30	-	-	236	43.9	W/P \$ 3405 PV \$ 3983
16-3072LP Recessed Front - Legal Pedestal		16-3072RP	72	30	30	-	-	236	43.9	W/P \$ 3031 PV \$ 3547
16-3066LPS Stepped Front - Letter Pedestal		16-3066RPS	66	30	30	-	-	223	40.0	W/P \$ 3154 PV \$ 3689
16-3066LP Recessed Front - Letter Pedestal		16-3066RP	66	30	30	-	-	223	40.0	W/P \$ 2808 PV \$ 3286

Description

- Rectangular Top
- Locking Pedestal
- Box/Box/File in Pedestal
- Black Utility Tray for Box Drawer

EXECUTIVE SINGLE FULL PED DESK RECTANGULAR TOP OVERHANG	Left Ped	Right Ped	W	D	H	K	R	Ship Wt	Cubic Ft	List Price
		16-3672LPSO Stepped Front - Legal Pedestal	16-3672RPSO	72	36	30	-	6	251	51.9
16-3072LPSO Stepped Front - Legal Pedestal		16-3072RPSO	72	30	30	-	6	220	43.9	W/P \$ 3298 PV \$ 3859
16-3066LPSO Stepped Front - Letter Pedestal		16-3066RPSO	66	30	30	-	6	207	40.0	W/P \$ 3050 PV \$ 3570

Description

- Rectangular Top
- Locking Pedestal
- Box/Box/File in Pedestal
- Black Utility Tray for Box Drawer

All pedestal desks shown as left.

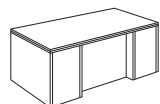

Stepped Front

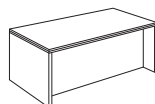

Recessed Front

For ordering options, see back of Madera Identification card at the beginning of section.

For grommet options, see page 254.

For center drawer options, see page 273.

Item	Model No.	W	D	H	K	R	Ship Wt	Cubic Ft	List Price
------	-----------	---	---	---	---	---	---------	----------	------------

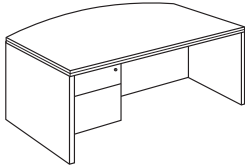
**EXECUTIVE DOUBLE
3/4 PED DESK BOW TOP**

Left Ped	Right Ped	W	D	H	K	R	Ship Wt	Cubic Ft	List Price
14-4272LP Recessed Front	14-4272RP	72	42-36	30	-	-	268	60.1	W/P \$ 3584 PV \$ 4193

Description

- Bow Top
- Legal Width Locking Pedestal
- Box/File in Pedestal
- Black Utility Tray for Box Drawer

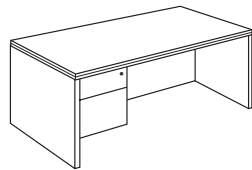
**EXECUTIVE SINGLE
3/4 PED DESK
RECTANGULAR TOP**

Left Ped	Right Ped	W	D	H	K	R	Ship Wt	Cubic Ft	List Price
14-3672LP Recessed Front - Legal Pedestal	14-3672RP	72	36	30	-	-	245	51.9	W/P \$ 2774 PV \$ 3245
14-3072LP Recessed Front - Legal Pedestal	14-3072RP	72	30	30	-	-	214	43.9	W/P \$ 2696 PV \$ 3155
14-3066LP Recessed Front - Letter Pedestal	14-3066RP	66	30	30	-	-	201	40.4	W/P \$ 2481 PV \$ 2903

Description

- Rectangular Top
- Locking Pedestal
- Box/File in Pedestal
- Black Utility Tray for Box Drawer

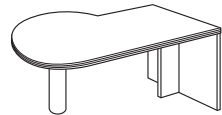
P-TOP

Left P	Right P	W	D	H	K	R	Ship Wt	Cubic Ft	List Price
14-4272PL	14-4272PR	72	42-36	30	-	-	155	58.4	W/P \$ 3664 PV \$ 4288

Description

- End Support
- Metal Base - 4 1/2" Diameter. Must Specify: Black or Aluminum.
- Not Recommended for Freestanding Applications

Options: Specify & Add

14-HMD	Optional 10" Modesty Panel	W/P \$ 209 PV \$ 245
14-FMD	Optional Full Modesty Panel	W/P \$ 347 PV \$ 406

NOTE: When specifying a center drawer and modesty panel use 1-1622CD.

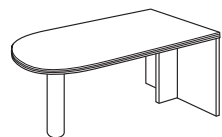
D-TOP

Left D	Right D	W	D	H	K	R	Ship Wt	Cubic Ft	List Price
14-3672DUL	14-3672DUR	72	36	30	-	-	149	52.1	W/P \$ 2681 PV \$ 3135
14-3072DUL	14-3072DUR	72	30	30	-	-	160	44	W/P \$ 2533 PV \$ 2964

Description

- End Support
- Metal Base - 4 1/2" Diameter. Must Specify: Black or Aluminum.
- Not Recommended for Freestanding Applications

Options: Specify & Add

14-HMD	Optional 10" Modesty Panel	W/P \$ 209 PV \$ 245
14-FMD	Optional Full Modesty Panel	W/P \$ 347 PV \$ 406

NOTE: 14-3072DUL/14-3072DUR Center Drawer and Keyboard Options are not Applicable with Modesty Panel Option.

NOTE: Center Drawers must be field installed.

NOTE: When specifying a center drawer and modesty panel use 1-1622CD.

All pedestal desks shown as left.

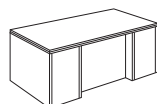

Stepped Front

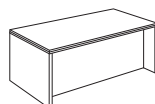

Recessed Front

For ordering options, see back of Madera Identification card at the beginning of section.

For grommet options, see page 254.

For center drawer options, see page 273.

Item	Model No.	W	D	H	K	R	Ship Wt	Cubic Ft	List Price	
EXECUTIVE RETURN FULL PEDESTAL BOX/BOX/FILE	Left Ped	Right Ped								
	16-2448LF	16-2448RF	48	24	30	31 3/4	-	140	22.9	W/P \$ 2283 PV \$ 2671
	16-2442LF	16-2442RF	42	24	30	25 3/4	-	130	19.9	W/P \$ 2229 PV \$ 2607

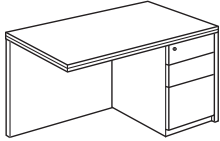
Description

- Letter Width Locking Pedestal
- Box/Box/File in Pedestal
- Grommet in Back Panel
- Grain Direction Runs Front to Back on Worksurface

Item	Model No.	W	D	H	K	R	Ship Wt	Cubic Ft	List Price	
EXECUTIVE RETURN FULL PEDESTAL FILE/FILE	Left Ped	Right Ped								
	16-2448LF2	16-2448RF2	48	24	30	31 3/4	-	140	22.9	W/P \$ 2283 PV \$ 2671
	16-2442LF2	16-2442RF2	42	24	30	25 3/4	-	130	19.9	W/P \$ 2229 PV \$ 2607

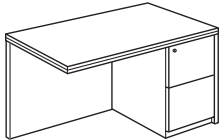
Description

- Letter Width Locking Pedestal
- File/File in Pedestal
- Grommet in Back Panel
- Grain Direction Runs Front to Back on Worksurface

Item	Model No.	W	D	H	K	R	Ship Wt	Cubic Ft	List Price	
EXECUTIVE RETURN FULL PEDESTAL BOX/BOX/FILE HALF MODESTY	Left Ped	Right Ped								
	16-2448LFH	16-2448RFH	48	24	30	31 3/4	-	132	22.9	W/P \$ 2221 PV \$ 2598
	16-2442LFH	16-2442RFH	42	24	30	25 3/4	-	122	19.9	W/P \$ 2177 PV \$ 2547

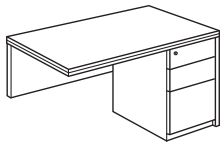
Description

- Letter Width Locking Pedestal
- Box/Box/File in Pedestal
- Grain Direction Runs Front to Back on Worksurface

Item	Model No.	W	D	H	K	R	Ship Wt	Cubic Ft	List Price	
EXECUTIVE RETURN FULL PEDESTAL FILE/FILE HALF MODESTY	Left Ped	Right Ped								
	16-2448LF2H	16-2448RF2H	48	24	30	31 3/4	-	132	22.9	W/P \$ 2221 PV \$ 2598
	16-2442LF2H	16-2442RF2H	42	24	30	25 3/4	-	122	19.9	W/P \$ 2177 PV \$ 2547

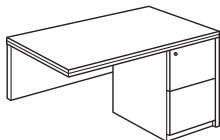
Description

- Letter Width Locking Pedestal
- File/File in Pedestal
- Grain Direction Runs Front to Back on Worksurface

All returns shown as right.

For ordering options, see back of Madera Identification card at the beginning of section.

For grommet options, see page 254.

For center drawer options, see page 273.

Item	Model No.	W	D	H	K	R	Ship Wt	Cubic Ft	List Price	
EXECUTIVE RETURN 3/4 PEDESTAL BOX/FILE 	Left Ped	Right Ped								
	14-2448LF	14-2448RF	48	24	30	31 3/4	-	132	22.9	W/P \$ 2096 PV \$ 2452
	14-2442LF	14-2442RF	42	24	30	25 3/4	-	122	19.9	W/P \$ 2049 PV \$ 2397

Description

- Letter Width Locking Pedestal
- Box/File in Pedestal
- Grommet in Back Panel
- Grain Direction Runs Front to Back on Worksurface

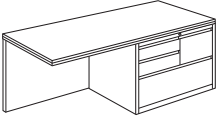
Item	Model No.	W	D	H	K	R	Ship Wt	Cubic Ft	List Price
EXECUTIVE RETURN MULTI-FILE PEDESTAL BOX/BOX/FILE/LATERAL 	Left Ped	Right Ped							
	14-2472LMR	14-2472RMR	72	24	30	36	-	227	29.0

Description

- Locking File Drawers Only
- Box/Box/File Over Lateral File
- Lateral File Provides Legal or Letter Filing Side to Side or Front to Back
- Grommet in Back Panel
- Grain Direction Runs Front to Back on Worksurface

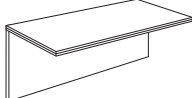
Item	Model No.	W	D	H	K	R	Ship Wt	Cubic Ft	List Price	
EXECUTIVE BRIDGE FULL MODESTY 	14-2448UF		48	24	30	48	-	82	6.2	W/P \$ 1067 PV \$ 1249
	14-2442UF		42	24	30	42	-	68	5.5	W/P \$ 990 PV \$ 1159
	14-2436UF		36	24	30	48	-	68	4.0	W/P \$ 937 PV \$ 1097

Description

- Grommet in Back Panel
- Grain Direction Runs Front to Back on Worksurface
- Hinged Modesty Panel

NOTE: Keyboards must be field installed.

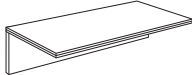
Item	Model No.	W	D	H	K	R	Ship Wt	Cubic Ft	List Price	
EXECUTIVE BRIDGE HALF MODESTY 	14-2448UFH		48	24	11 3/16	48	-	62	6.2	W/P \$ 978 PV \$ 1144
	14-2442UFH		42	24	11 3/16	42	-	48	5.5	W/P \$ 897 PV \$ 1051
	14-2436UFH		36	24	11 3/16	48	-	48	4.0	W/P \$ 866 PV \$ 1014

Description

- Grain Direction Runs Front to Back on Worksurface
- Hinged Modesty Panel

NOTE: Keyboards must be field installed.

All returns shown as right.

For ordering options, see back of Madera Identification card at the beginning of section.

For grommet options, see page 254.

Item	Model No.	W	D	H	K	R	Ship Wt	Cubic Ft	List Price
CORNER UNIT	14-4242CU	42	42	30	25 ⁷ / ₁₆	-	145	34.5	W/P \$ 2268 PV \$ 2654
	14-3636CU	36	36	30	17	-	135	25.7	W/P \$ 2174 PV \$ 2543

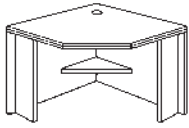
Description

- Connects to 24" Deep Bridge and Return Units
- Grommets in Top
- Grain Direction Runs Front to Back on Worksurface

NOTE: Not all keyboards will fit the 14-3636CU. Recommended keyboards are 1-KCWR, 1-KCPR, and 1-KC.

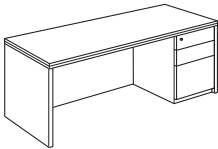
**EXECUTIVE CREDENZA
FULL PEDESTAL
BOX/BOX/FILE**

Left Ped		Right Ped		W	D	H	K	R	Ship Wt	Cubic Ft	List Price
16-2472LC	16-2472RC	72	24	30	28 ³ / ₄	-	199	35.6	W/P \$ 2734 PV \$ 3199		
Legal Pedestal											
16-2466LC	16-2466RC	66	24	30	25 ³ / ₄	-	182	32.7	W/P \$ 2561 PV \$ 2996		
Letter Pedestal											
16-2072LC	16-2072RC	72	20	30	28 ³ / ₄	-	183	30.5	W/P \$ 2516 PV \$ 2943		
Legal Pedestal											
16-2066LC	16-2066RC	66	20	30	25 ³ / ₄	-	167	27.8	W/P \$ 2356 PV \$ 2757		
Letter Pedestal											

Description

- Locking Pedestal
- Box/Box/File in Pedestal
- Grommet in Back Panel

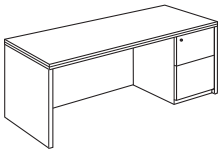
**EXECUTIVE CREDENZA
FULL PEDESTAL
FILE/FILE**

Left Ped		Right Ped		W	D	H	K	R	Ship Wt	Cubic Ft	List Price
16-2472LC2	16-2472RC2	72	24	30	28 ³ / ₄	-	199	35.6	W/P \$ 2734 PV \$ 3199		
Legal Pedestal											
16-2466LC2	16-2466RC2	66	24	30	25 ³ / ₄	-	182	32.7	W/P \$ 2561 PV \$ 2996		
Letter Pedestal											
16-2072LC2	16-2072RC2	72	20	30	28 ³ / ₄	-	178	30.5	W/P \$ 2516 PV \$ 2943		
Legal Pedestal											
16-2066LC2	16-2066RC2	66	20	30	25 ³ / ₄	-	167	27.8	W/P \$ 2356 PV \$ 2757		
Letter Pedestal											

Description

- Locking Pedestal
- File/File in Pedestal
- Grommet in Back Panel

All credenzas shown as right.

For ordering options, see back of Madera Identification card at the beginning of section.

For grommet options, see page 254.

Item	Model No.	W	D	H	K	R	Ship Wt	Cubic Ft	List Price	
EXECUTIVE CREDENZA FULL PEDESTAL BOX/BOX/FILE HALF MODESTY	Left Ped	Right Ped								
	16-2472LCH Legal Pedestal	16-2472RCH	72	24	30	28 3/4	-	242	35.6	W/P \$ 2630 PV \$ 3078
	16-2466LCH Letter Pedestal	16-2466RCH	66	24	30	28 3/4	-	170	32.7	W/P \$ 2463 PV \$ 2882

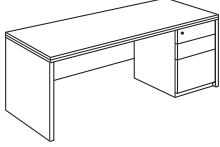
Description

- Locking Pedestal
- Box/Box/File in Pedestal

Item	Model No.	W	D	H	K	R	Ship Wt	Cubic Ft	List Price	
EXECUTIVE CREDENZA FULL PEDESTAL FILE/FILE HALF MODESTY	Left Ped	Right Ped								
	16-2472LC2H Legal Pedestal	16-2472RC2H	72	24	30	28 3/4	-	242	35.6	W/P \$ 2630 PV \$ 3078
	16-2466LC2H Letter Pedestal	16-2466RC2H	66	24	30	28 3/4	-	170	32.7	W/P \$ 2463 PV \$ 2882

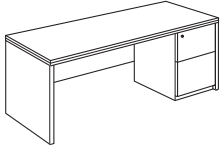
Description

- Locking Pedestal
- File/File in Pedestal

Item	Model No.	W	D	H	K	R	Ship Wt	Cubic Ft	List Price	
EXECUTIVE CREDENZA 3/4 PEDESTAL BOX/FILE	Left Ped	Right Ped								
	14-2072LC Legal Pedestal	14-2072RC	72	20	30	28 3/4	-	172	30.5	W/P \$ 2301 PV \$ 2692
	14-2066LC Letter Pedestal	14-2066RC	66	20	30	25 3/4	-	158	27.8	W/P \$ 2108 PV \$ 2467

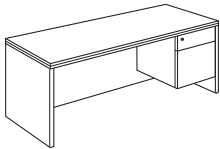

Description

- Locking Pedestal
- Box/File in Pedestal
- Grommet in Back Panel

All credenzas shown as right.

For ordering options, see back of Madera Identification card at the beginning of section.

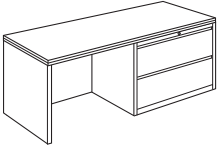
For grommet options, see page 254.

Item	Model No.	W	D	H	K	R	Ship Wt	Cubic Ft	List Price	
EXECUTIVE CREDENZA LATERAL FILE 	Left Ped	Right Ped								
	14-2472LL 36" Pedestal	14-2472RL	72	24	30	12	-	277	35.6	W/P \$ 2976 PV \$ 3482
	14-2466LL 36" Pedestal	14-2466RL	66	24	30	6	-	264	32.7	W/P \$ 2926 PV \$ 3425
	14-2472LL3 30" Pedestal	14-2472RL3	72	24	30	12	-	267	35.6	W/P \$ 2841 PV \$ 3325
	14-2466LL3 30" Pedestal	14-2466RL3	66	24	30	6	-	254	32.7	W/P \$ 2793 PV \$ 3267
	14-2072LL 36" Pedestal	14-2072RL	72	20	30	12	-	224	30.2	W/P \$ 2760 PV \$ 3230
	14-2066LL 36" Pedestal	14-2066RL	66	20	30	6	-	215	27.8	W/P \$ 2715 PV \$ 3177

Description

- Central Locking
- Two Lateral Files
- Grommet in Back Panel

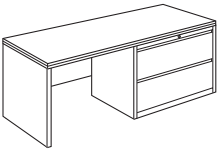
Item	Model No.	W	D	H	K	R	Ship Wt	Cubic Ft	List Price	
EXECUTIVE CREDENZA 36"W LATERAL FILE HALF MODESTY 	Left Ped	Right Ped								
	14-2472LLH 36" Pedestal	14-2472RLH	72	24	30	12	-	273	35.6	W/P \$ 2904 PV \$ 3398
	14-2466LLH 36" Pedestal	14-2466RLH	66	24	30	6	-	260	32.7	W/P \$ 2867 PV \$ 3355
	14-2472LL3H 30" Pedestal	14-2472RL3H	72	24	30	12	-	263	35.6	W/P \$ 2758 PV \$ 3228
14-2466LL3H 30" Pedestal	14-2466RL3H	66	24	30	6	-	250	32.7	W/P \$ 2722 PV \$ 3184	

Description

- Central Locking
- Two Lateral Files

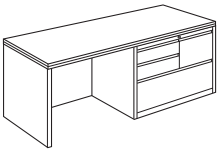
Item	Model No.	W	D	H	K	R	Ship Wt	Cubic Ft	List Price	
EXECUTIVE CREDENZA MULTI-FILE BOX/BOX/FILE/LATERAL 	Left Ped	Right Ped								
	14-2072LL4	14-2072RL4	72	20	30	12	-	231	29.0	W/P \$ 3131 PV \$ 3664
	14-2066LL4	14-2066RL4	66	20	30	6	-	219	27.8	W/P \$ 3088 PV \$ 3614

Description

- Locking File Drawers Only
- Box/Box/File Over Lateral File
- Lateral File Provides Legal or Letter Filing Side to Side or Front to Back
- Grommet in Back Panel

All credenzas shown as right.

For ordering options, see back of Madera Identification card at the beginning of section.

For grommet options, see page 254.

Item	Model No.	W	D	H	K	R	Ship Wt	Cubic Ft	List Price
TRANSACTION RISER FOR DESKS/CREDENZAS	14-1270TR	70 5/8	12	13 3/16	-	-	62	9.7	W/P \$ 1689 PV \$ 1976
	For Use with 72" Worksurfaces								
	14-1264TR	64 5/8	12	13 3/16	-	-	56	8.9	W/P \$ 1514 PV \$ 1771
	For Use with 66" Worksurfaces								

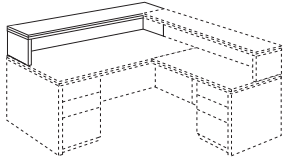
Description

- Freestanding Riser for Desks or Credenzas
- May Be Used in Conjunction with Return Risers or Bridge Risers

TRANSACTION RISER FOR RETURNS	Left Ped	Right Ped	W	D	H	K	R	Ship Wt	Cubic Ft	List Price
		14-0971LU	14-0971RU	71	9	13 3/16	-	-	45	6.8
For Use with 36" Desks and 48" Returns										
	14-0959LU	14-0959RU	59	9	13 3/16	-	-	40	6.1	W/P \$ 1382 PV \$ 1617
For Use with 30" Desks and 42" Returns										

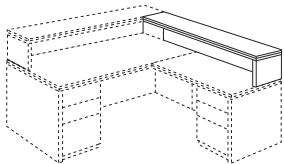
Description

- Must Be Used in Conjunction with a Desk Riser
- Grain Direction Runs Front to Back on Worksurface on Veneer Surfaces Only

TRANSACTION RISER FOR BRIDGES	14-0978BU	78	9	13 3/16	-	-	48	7.9	W/P \$ 1548 PV \$ 1810
	For Use with 36" Desk, 48" Bridge, and Credenza								
	14-0966BU	66	9	13 3/16	-	-	43	6.5	W/P \$ 1394 PV \$ 1632
	For Use with 30" Desk, 42" Bridge, and Credenza								

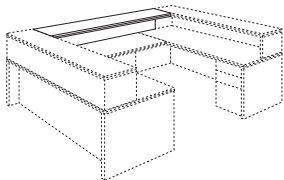
Description

- Must Be Used in Conjunction with Two Desk/Credenza Risers
- Grain Direction Runs Front to Back on Worksurface on Veneer Surfaces Only

For ordering options, see back of Madera Identification card at the beginning of section.

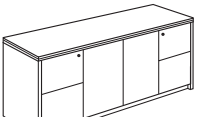
Item	Model No.	W	D	H	K	R	Ship Wt	Cubic Ft	List Price
STORAGE CREENZA FULL PEDESTAL 	16-2472SC Legal Width Ped	72	24	30	-	-	285	35.6	W/P \$ 3774 PV \$ 4416
	16-2466SC Letter Width Ped	66	24	30	-	-	261	32.7	W/P \$ 3452 PV \$ 4038
	16-2072SC Legal Width Ped	72	20	30	-	-	270	30.5	W/P \$ 3561 PV \$ 4167

Description

- Locking Pedestals
- File/File in Pedestals
- Fixed Storage Shelf Behind Doors

STORAGE CREENZA 3/4 PEDESTAL 	14-2072SC	72	20	30	-	-	227	30.5	W/P \$ 3084 PV \$ 3609
--	-----------	----	----	----	---	---	-----	------	---------------------------

Description

- Locking Pedestals
- Box/File in Legal Width Pedestals

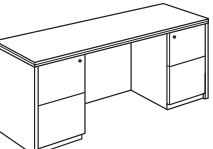
KNEESPACE CREENZA FULL PEDESTAL 	16-2472KC Legal Ped	72	24	30	33 1/2	-	240	35.6	W/P \$ 3490 PV \$ 4084
	16-2466KC Letter Ped	66	24	30	33 1/2	-	220	32.7	W/P \$ 3191 PV \$ 3732
	16-2072KC Legal Ped	72	20	30	33 1/2	-	223	30.5	W/P \$ 3252 PV \$ 3804
	16-2066KC Letter Ped	66	20	30	33 1/2	-	221	27.8	W/P \$ 2972 PV \$ 3477

Description

- Locking Pedestals
- File/File in Pedestals
- Grommet in Back Panel

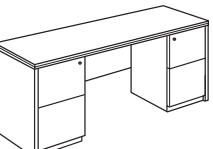
KNEESPACE CREENZA FULL PEDESTAL HALF MODESTY 	16-2472KCH Legal Ped	72	24	30	33 1/2	-	236	35.6	W/P \$ 3422 PV \$ 4005
	16-2466KCH Letter Ped	66	24	30	33 1/2	-	216	32.7	W/P \$ 3123 PV \$ 3654

Description

- Locking Pedestals
- File/File in Pedestals

For ordering options, see back of Madera Identification card at the beginning of section.

For grommet options, see page 254.

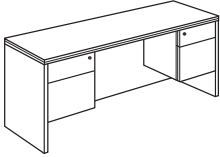
Item	Model No.	W	D	H	K	R	Ship Wt	Cubic Ft	List Price
KNEESPACE CREENZA 3/4 PEDESTAL 	14-2072KC	72	20	30	33 1/2	-	229	30.5	W/P \$ 2769
	Legal Ped								PV \$ 3239
	14-2066KC	66	20	30	33 1/2	-	195	27.8	W/P \$ 2576
	Letter Ped								PV \$ 3013

Description

- Locking Pedestals
- Box/File in Pedestals
- Grommet in Back Panel

DOUBLE LATERAL CREENZA 	14-2072DL	72	20	30	-	-	303	30.2	W/P \$ 4153
									PV \$ 4859

Description

- Dual Locking
- File Drawers Provide Legal or Letter Filing

FOUR DRAWER LATERAL FILE 	14-2436L4	36	24	53 3/8	-	-	312	32.6	W/P \$ 4272
									PV \$ 5000
	14-2430L4	30	24	53 3/8	-	-	260	27.5	W/P \$ 4019
									PV \$ 4703
	14-2036L4	36	20	53 3/8	-	-	276	28.3	W/P \$ 3997
									PV \$ 4676

Description

- Central Locking
- Anti-Tilt System
- File Drawers Provide Legal or Letter Filing

THREE DRAWER LATERAL FILE 	14-2436L3	36	24	42	-	-	235	24.9	W/P \$ 3411
									PV \$ 3991
	14-2430L3	30	24	42	-	-	204	21.9	W/P \$ 3208
									PV \$ 3754

Description

- Central Locking
- Anti-Tilt System
- File Drawers Provide Legal or Letter Filing

For ordering options, see back of Madera Identification card at the beginning of section.

For grommet options, see page 254.

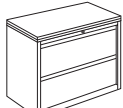
Item	Model No.	W	D	H	K	R	Ship Wt	Cubic Ft	List Price
TWO DRAWER LATERAL FILE 	14-2436L2	36	24	30	-	-	184	18.3	W/P \$ 2265 PV \$ 2650
	14-2430L2	30	24	30	-	-	153	15.6	W/P \$ 2131 PV \$ 2492
	14-2036L2	36	20	30	-	-	153	15.5	W/P \$ 2118 PV \$ 2478

Description

- Central Locking
- Anti-Tilt System
- File Drawers Provide Legal or Letter Filing

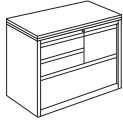
MULTI-FILE 	14-2036MF	36	20	30	-	-	185	14.9	W/P \$ 2545 PV \$ 2978
---	-----------	----	----	----	---	---	-----	------	---------------------------

Description

- File Locking Only
- Upper Section - Box/Box/File
- Lower Section - Lateral File
- File Drawers Provide Legal or Letter Filing

MOBILE PEDESTAL 	14-1619MP1	16	19	28 1/2	-	-	90	9.0	W \$ 1832 PV \$ 2143
--	------------	----	----	--------	---	---	----	-----	-------------------------

Description

- Locking Pedestal
- Box/Box/File
- Casters
- Fits Underneath 30" High Worksurfaces
- Finger Pull Option Not Available

For ordering options, see back of Madera Identification card at the beginning of section.

For grommet options, see page 254.

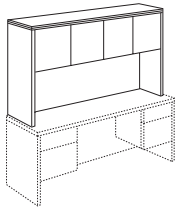
Item	Model No.	Width Edges A, B, D	Width Edges E, X, Y	D	H	K	R	Ship Wt	Cubic Ft	List Price
WOOD DOOR SURFACE MOUNT HUTCH 	14-1596HU Six Doors	96	93	15 1/4	40	-	-	305	41.0	W \$ 3970 PV \$ 4645
	14-1590HU Five Doors	90	87	15 1/4	40	-	-	285	38.9	W \$ 3615 PV \$ 4229
	14-1584HU Five Doors	84	81	15 1/4	40	-	-	270	36.8	W \$ 3365 PV \$ 3936
	14-1578HU Four Doors	78	75	15 1/4	40	-	-	260	33.8	W \$ 2999 PV \$ 3508
	14-1572HU Four Doors	72	69	15 1/4	40	-	-	205	33.1	W \$ 2727 PV \$ 3190
	14-1566HU Four Doors	66	63	15 1/4	40	-	-	193	32.9	W \$ 2595 PV \$ 3036

Description

- Overall Width of Unit will be Determined by Edge Detail Selected
- Grommet
- 22 1/2" Clearance Below Wood Doors

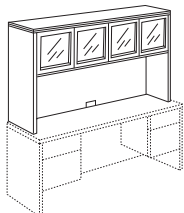
ACRYLIC DOOR SURFACE MOUNT HUTCH 	14-1572AH	72	69	15 1/4	40	-	-	186	33.1	W \$ 2996 PV \$ 3506
	14-1566AH	66	63	15 1/4	40	-	-	235	24.3	W \$ 2861 PV \$ 3346

Description

- Overall Width of Unit will be Determined by Edge Detail Selected
- Grommet
- 22 1/2" Clearance Below Wood Framed Acrylic Doors

Options: Specify & Add

CA	Clear Acrylic Door Inserts	Included
FA	Frosted Acrylic Door Inserts	Included

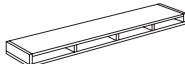
OPTIONAL PAPER SLOTS FOR SURFACE MOUNT HUTCHES 	14-1194PS Six Slots	93 5/8	90 5/8	11 7/8	5 1/4	-	-	55	4.2	W \$ 1850 PV \$ 2164
	14-1188PS Five Slots	87 5/8	84 5/8	11 7/8	5 1/4	-	-	52	3.9	W \$ 1715 PV \$ 2007
	14-1182PS Five Slots	81 5/8	78 5/8	11 7/8	5 1/4	-	-	49	3.7	W \$ 1584 PV \$ 1852
	14-1176PS Four Slots	75 5/8	72 5/8	11 7/8	5 1/4	-	-	45	3.4	W \$ 1447 PV \$ 1693
	14-1170PS Four Slots	69 5/8	66 5/8	11 7/8	5 1/4	-	-	42	3.1	W \$ 1314 PV \$ 1537
	14-1164PS Four Slots	63 5/8	60 5/8	11 7/8	5 1/4	-	-	38	2.9	W \$ 1181 PV \$ 1382

Description

- Overall Width of Units will be Determined by Edge Detail Selected
- Optional Paper Slot for Surface Mount Hutches
- Ships Factory Installed

For ordering options, see back of Madera Identification card at the beginning of section.

Item	Model No.	W	D	H	K	R	Ship Wt	Cubic Ft	List Price
WOOD DOOR WALL MOUNT HUTCH	14-1536WD	36	15 1/4	17 1/2	-	-	70	7.60	W \$ 1511 PV \$ 1767

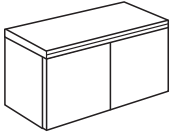
Description

- Mounts to Wall with Mounting Bracket Included
- Storage Behind Wood Doors
- Profiled on Front Only for Multiple Unit Application

NOTE: Indiana Furniture will not be liable for wall mount hutch units that are not properly installed.

ACRYLIC DOOR WALL MOUNT HUTCH	14-1536AW	36	15 1/4	17 1/2	-	-	70	7.60	W \$ 1626 PV \$ 1902
----------------------------------	-----------	----	--------	--------	---	---	----	------	-------------------------

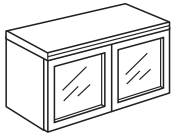
Description

- Mounts to Wall with Mounting Bracket Included
- Storage Behind Acrylic Doors
- Profiled on Front Only for Multiple Unit Application

Options: Specify & Add

CA	Clear Acrylic Door Inserts	Included
FA	Frosted Acrylic Door Inserts	Included

NOTE: Indiana Furniture will not be liable for wall mount hutch units that are not properly installed.

TOP UNIT BOOKCASE	14-1534TU	34	15 1/4	40	-	-	114	15.80	W \$ 1353 PV \$ 1584
	14-1528TU	28	15 1/4	40	-	-	125	16.40	W \$ 1150 PV \$ 1346

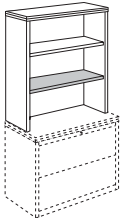
Description

- Fixed Bottom Shelf with 12" Clearance
- One Adjustable Shelf
- For Use on Two Drawer Lateral Files or Credenzas

For ordering options, see back of Madera Identification card at the beginning of section.

For tackboard and tasklights, see page 285.

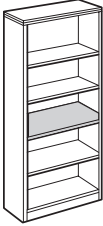
Item	Model No.	W	D	H	K	R	Ship Wt	Cubic Ft	List Price	
	14-3684BC	36	15 1/4	84	-	-	205	31.3	W \$ 2840 PV \$ 3324	
	Four Adjustable Shelves - One Fixed Shelf									
	14-3670BC	36	15 1/4	69 3/8	-	-	176	26.9	W \$ 2358 PV \$ 2759	
	Three Adjustable Shelves - One Fixed Shelf									
	14-3660BC	36	15 1/4	60	-	-	147	23.2	W/P \$ 1957 PV \$ 2291	
	Three Adjustable Shelves									
	14-3648BC	36	15 1/4	48 7/16	-	-	120	18.7	W/P \$ 1769 PV \$ 2069	
	Two Adjustable Shelves									
	14-3630BC	36	15 1/4	30	-	-	75	11.9	W/P \$ 1710 PV \$ 2000	
	One Adjustable Shelf									
14-1570BC	34	15 1/4	69 3/8	-	-	198	26.9	W \$ 2228 PV \$ 2606		
Three Adjustable Shelves										
14-1548BC	34	15 1/4	48 7/16	-	-	135	18.6	W/P \$ 1671 PV \$ 1954		
Two Adjustable Shelves										
14-1530BC	34	15 1/4	30	-	-	85	11.1	W/P \$ 1615 PV \$ 1889		
One Adjustable Shelf										

Description

- 1" Thick Shelves

WARDROBE/STORAGE CABINET	Left Hinged	Right Hinged	W	D	H	K	R	Ship Wt	Cubic Ft	List Price
	14-1870WL	14-1870WR	18	24	69 3/8	-	-	153	19.2	W \$ 3299 PV \$ 3861
14-1870CL	14-1870CR	18	20	69 3/8	-	-	174	19.0	W \$ 2792 PV \$ 3266	

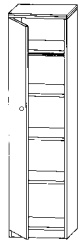
Description

- Fixed Top Shelf
- Coat Rod Under Fixed Shelf
- Three Adjustable/Removable Shelves

NOTE: If ordered with finger pull, a knob pull will be standard.

WARDROBE/STORAGE CABINET	14-3670WD	36	24	69 3/8	-	-	290	42.0	W \$ 5825 PV \$ 6816
--------------------------	-----------	----	----	--------	---	---	-----	------	-------------------------



Description

- Fixed Top Shelf Behind Each Door
- Coat Rod Under Each Fixed Shelf
- Three Adjustable/Removable Shelves

NOTE: If ordered with finger pull, a knob pull will be standard.

For ordering options, see back of Madera Identification card at the beginning of section.

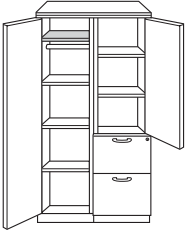
Item	Model No.	W	D	H	K	R	Ship Wt	Cubic Ft	List Price	
WARDROBE/STORAGE CABINET FILE/FILE	Left Drawers									
	Right Drawers									
	14-3670WD2L	14-3670WD2R	36	24	69 ³ / ₈	-	-	315	42.0	W \$ 6662 PV \$ 7795



Pictured as Right

Description

- One Side – Fixed Top Shelf, Coat Rod, and Three Adjustable Shelves
- One Side – Top Storage with Two Adjustable Shelves, Bottom Locking File/File
- Pedestal Determines Left or Right Handed Unit

NOTE: Finger pull not available.

Item	Model No.	W	D	H	K	R	Ship Wt	Cubic Ft	List Price	
WARDROBE/STORAGE CABINET BOX/BOX/FILE	Left Drawers									
	Right Drawers									
	14-3670WD1L	14-3670WD1R	36	24	69 ³ / ₈	-	-	315	42.0	W \$ 6662 PV \$ 7795



Pictured as Right

Description

- One Side – Fixed Top Shelf, Coat Rod, and Three Adjustable Shelves
- One Side – Top Storage with Two Adjustable Shelves, Bottom Locking Box/Box/File
- Pedestal Determines Left or Right Handed Unit

NOTE: Finger pull not available.

Item	Model No.	W	D	H	K	R	Ship Wt	Cubic Ft	List Price	
WOOD DOORS STORAGE CABINET FILE/FILE	14-3670SU2		36	24	69 ³ / ₈	-	-	298	42.0	W \$ 6375 PV \$ 7458

Description

- Top Section has Two Adjustable Shelves
- Bottom Section File/File with Letter or Legal Filing Capabilities and Locking
- 170° Hinge on Doors

NOTE: If ordered with finger pull, a black knob pull will be standard.

For ordering options, see back of Madera Identification card at the beginning of section.

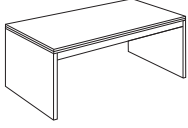
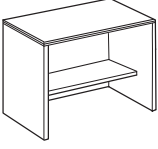
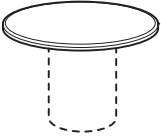
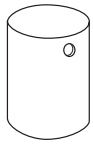
Item	Model No.	W	D	H	K	R	Ship Wt	Cubic Ft	List Price
WORK TABLE 	14-3672WT	72	36	30	69 11/16	-	195	50.0	W/P \$ 2006 PV \$ 2346
	14-3060WT	60	30	30	57 11/16	-	134	35.5	W/P \$ 1569 PV \$ 1837
Description <ul style="list-style-type: none"> • Slab Ends • Apron Rails 									
COMPUTER WORK TABLE 	14-2445CW	45	24	26 3/8	42 11/16	-	120	21.8	W/P \$ 1623 PV \$ 1900
	14-2436CW	36	24	26 3/8	33 11/16	-	110	17.6	W/P \$ 1554 PV \$ 1817
Description <ul style="list-style-type: none"> • Fixed Shelf is 12" Deep with a 16" Clearance • Grommet in Back Panel 									
Options: Specify & Add									
CS-14BL Optional Black Caster									\$ 150
CIRCULAR CONFERENCE TABLE 	14-4848CT	48	48	30	-	-	60	5.7	W/P \$ 1802 PV \$ 2107
	Accommodates 5 Chairs								
	14-4242CT	42	42	30	-	-	40	4.4	W/P \$ 1635 PV \$ 1913
Accommodates 4 Chairs									
14-3636CT	36	36	30	-	-	35	3.4	W/P \$ 1435 PV \$ 1679	
Accommodates 3-4 Chairs									
Description <ul style="list-style-type: none"> • Top and Base Sold Separately 									
CYLINDER BASE 	01-2020CB	20	20	28 1/2	-	-	136	10.9	W \$ 977 PV \$ 1142
	For Use with 42" or 48" Circular Tops								
01-1616CB									W \$ 892 PV \$ 1044
For Use with 36" Circular Tops									
Description <ul style="list-style-type: none"> • Veneer Cylinder Base • Weighted for Stability • 2 Wire Management Grommets Standard at Top with 8" Opening Standard in Bottom 									
Options: Specify & Add									
GCB1S Optional Grommet Top Edge (1)									\$ N/C
NOGC Optional No Grommets At Top Edges									\$ N/C

For ordering options, see back of Madera Identification card at the beginning of section.

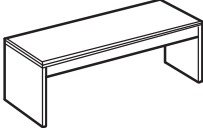
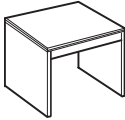
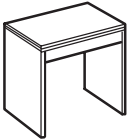
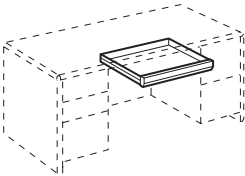
Item	Model No.	W	D	H	K	R	Ship Wt	Cubic Ft	List Price
MAGAZINE TABLE	14-1847MT	47	18	15 7/16	-	-	75	9.9	W/P \$ 935 PV \$ 1095
	Description								
	<ul style="list-style-type: none"> • Slab Ends • Apron Rails 								
LAMP TABLE	14-2828LT	28	28	21 7/16	-	-	56	12.3	W/P \$ 1109 PV \$ 1299
	Description								
	<ul style="list-style-type: none"> • Slab Ends • Apron Rails 								
END TABLE	14-1824ET	24	18	21 7/16	-	-	48	7.6	W/P \$ 856 PV \$ 1002
	Description								
	<ul style="list-style-type: none"> • Slab Ends • Apron Rails 								
CENTER DRAWER	01-2122CD	22	20 5/8	2 3/4	-	-	13	1.7	\$ 332
	01-1622CD	22	16 5/8	2 3/4	-	-	7	1.4	\$ 310
	Description								
	<ul style="list-style-type: none"> • Beveled Drawer Front • 3/4 Extension • Wood Drawer Interiors with Built in Pen Tray 								
	Options: Specify & Add								
	Factory Installed								\$ 130

For ordering options, see back of Madera Identification card at the beginning of section.

Item	Model No.	W	D	H	K	R	Ship Wt	Cubic Ft	List Price
BOW TOP DESK WORKSURFACE 	14-4272BWT	72	42-36	1 ³ / ₁₆	-	-	125	7.1	W/P \$ 1653 PV \$ 1933
	14-3672BWT	72	36-30	1 ³ / ₁₆	-	-	110	6.2	W/P \$ 1572 PV \$ 1840

Description

- Shaped on Four Sides
- Not Recommended for Use With Center Grommet

Item	Model No.	W	D	H	K	R	Ship Wt	Cubic Ft	List Price
DESK WORKSURFACE 36" DEEP 	14-3678TP	78	36	1 ³ / ₁₆	-	-	125	7.0	W/P \$ 1269 PV \$ 1485
	14-3672TP	72	36	1 ³ / ₁₆	-	-	115	6.5	W/P \$ 1212 PV \$ 1418
	14-3666TP	66	36	1 ³ / ₁₆	-	-	105	6.0	W/P \$ 1166 PV \$ 1363

Description

- Shaped on Four Sides
- When 36" Deep Modular Tops have a Kneespace of 60" or Greater, a Support Panel is Needed to Support the Top, See Page 282
- For Table Lift Options, See Accessories
- Table Lifts to be used with Vertical Profiles — D, E, X, Y

For ordering options, see back of Madera Identification card at the beginning of section.

For grommet options, see page 254.

Item	Model No.	W	D	H	K	R	Ship Wt	Cubic Ft	List Price
DESK WORKSURFACE 30" DEEP 	14-3084TP	84	30	1 ³ / ₁₆	-	-	95	5.3	W/P \$ 1183 PV \$ 1385
	14-3078TP	78	30	1 ³ / ₁₆	-	-	90	4.9	W/P \$ 1132 PV \$ 1323
	14-3072TP	72	30	1 ³ / ₁₆	-	-	85	4.6	W/P \$ 1081 PV \$ 1265
	14-3066TP	66	30	1 ³ / ₁₆	-	-	80	4.2	W/P \$ 1039 PV \$ 1215
	14-3060TP	60	30	1 ³ / ₁₆	-	-	75	3.8	W/P \$ 994 PV \$ 1163
	14-3054TP	54	30	1 ³ / ₁₆	-	-	70	3.4	W/P \$ 958 PV \$ 1121
	14-3048TP	48	30	1 ³ / ₁₆	-	-	60	3.1	W/P \$ 923 PV \$ 1080
	14-3042TP	42	30	1 ³ / ₁₆	-	-	55	2.7	W/P \$ 886 PV \$ 1037

Description

- Shaped on Four Sides
- When 30" Deep Modular Tops have a Kneespace of 60" or Greater, a Support Panel is Needed to Support the Top, See Page 282
- For Table Lift Options, See Accessories
- Table Lifts to be used with Vertical Profiles — D, E, X, Y

For ordering options, see back of Madera Identification card at the beginning of section.

For grommet options, see page 254.

Item	Model No.	W	D	H	K	R	Ship Wt	Cubic Ft	List Price
MODULAR CREDENZA TOP 24" DEEP 	14-24108TP	108	24	1 3/16	-	-	110	6.6	W/P \$ 1711 PV \$ 2003
	14-24102TP	102	24	1 3/16	-	-	105	6.3	W/P \$ 1640 PV \$ 1918
	14-2496TP	96	24	1 3/16	-	-	100	5.0	W/P \$ 1196 PV \$ 1399
	14-2490TP	90	24	1 3/16	-	-	95	4.6	W/P \$ 1125 PV \$ 1315
	14-2484TP	84	24	1 3/16	-	-	90	4.3	W/P \$ 1046 PV \$ 1225
	14-2478TP	78	24	1 3/16	-	-	85	4.0	W/P \$ 1002 PV \$ 1173
	14-2472TP	72	24	1 3/16	-	-	80	3.7	W/P \$ 966 PV \$ 1131
	14-2466TP	66	24	1 3/16	-	-	75	3.4	W/P \$ 929 PV \$ 1088
	14-2460TP	60	24	1 3/16	-	-	70	3.0	W/P \$ 899 PV \$ 1053
	14-2454TP	54	24	1 3/16	-	-	65	2.8	W/P \$ 848 PV \$ 993
	14-2448TP	48	24	1 3/16	-	-	55	2.5	W/P \$ 814 PV \$ 953
	14-2442TP	42	24	1 3/16	-	-	50	2.2	W/P \$ 775 PV \$ 908
	14-2436TP	36	24	1 3/16	-	-	45	2.0	W/P \$ 755 PV \$ 884
	14-2430TP	30	24	1 3/16	-	-	36	1.6	W/P \$ 724 PV \$ 848
	14-2418TP	18	24	1 3/16	-	-	28	1.0	W/P \$ 668 PV \$ 782

Description

- Shaped on Four Sides
- For Use on 24" Deep Pedestals/Files
- When 24" Deep Modular Tops have a Kneespace of 60" or Greater, a Support Panel is Needed to Support the Top, See Page 282
- For Table Lift Options, See Accessories
- Table Lifts to be used with Vertical Profiles – D, E, X, Y

For ordering options, see back of Madera Identification card at the beginning of section.

For grommet options, see page 254.

Item	Model No.	W	D	H	K	R	Ship Wt	Cubic Ft	List Price	
MODULAR RETURN TOP 24" DEEP 	Left Ped		Right Ped							
	14-7224TPL	14-7224TPR	72	24	1 3/16	-	-	80	3.7	W/P \$ 966 PV \$ 1131
	Grain Direction Runs Left to Right on Laminate Top									
	14-6624TPL	14-6624TPR	66	24	1 3/16	-	-	75	3.4	W/P \$ 929 PV \$ 1088
	Grain Direction Runs Left to Right on Laminate Top									
	14-6024TPL	14-6024TPR	60	24	1 3/16	-	-	70	3.1	W/P \$ 899 PV \$ 1053
	Grain Direction Runs Left to Right on Laminate Top									
	14-5424TPL	14-5424TPR	54	24	1 3/16	-	-	65	2.8	W/P \$ 848 PV \$ 993
	14-4824TPL	14-4824TPR	48	24	1 3/16	-	-	55	2.5	W/P \$ 814 PV \$ 953
14-4224TPL	14-4224TPR	42	24	1 3/16	-	-	50	2.2	W/P \$ 775 PV \$ 908	
14-3624TPL	14-3624TPR	36	24	1 3/16	-	-	45	1.9	W/P \$ 755 PV \$ 884	

Description

- Shaped on Four Sides with Reverse Profile on One End
- For Use on 24" Deep Pedestals/Files
- Grain Direction Runs Front to Back on Worksurface Unless Noted Above
- When 24" Deep Modular Tops have a Kneespace of 60" or Greater, a Support Panel is Needed to Support the Top, See Page 282
- For Table Lift Options, See Accessories
- Table Lifts to used with Vertical Profiles — D, E, X, Y

MODULAR BRIDGE TOP 24" DEEP 	14-6024TPB	60	24	1 3/16	-	-	70	3.1	W/P \$ 899 W \$ 1053	
	Grain Direction Runs Left to Right on Laminate Worksurface									
	14-5424TPB	54	24	1 3/16	-	-	65	2.8	W/P \$ 848 W \$ 993	
	14-4824TPB	48	24	1 3/16	-	-	55	2.5	W/P \$ 814 W \$ 953	
	14-4224TPB	42	24	1 3/16	-	-	50	2.2	W/P \$ 775 W \$ 908	
	14-3624TPB	36	24	1 3/16	-	-	45	1.9	W/P \$ 755 W \$ 884	

Description

- Shaped on Four Sides with Reverse Profile on Each End
- Grain Direction Runs Front to Back on the Worksurface Unless Noted Above
- When 24" Deep Modular Tops have a Kneespace of 60" or Greater, a Support Panel is Needed to Support the Top, See Page 282.

For ordering options, see back of Madera Identification card at the beginning of section.

For grommet options, see page 254.

Item	Model No.	W	D	H	K	R	Ship Wt	Cubic Ft	List Price
MODULAR PEDESTAL BOX/BOX/FILE 	14-3618PD1	18	35 1/4	28 1/4	-	-	125	13.6	W \$ 1784 PV \$ 2089
	14-3018PD1	18	29 1/4	28 1/4	-	-	105	11.6	W \$ 1694 PV \$ 1982
	14-2418PD1	18	23 1/4	28 1/4	-	-	85	9.5	W \$ 1618 PV \$ 1893

Description

- Locking
- Box/Box/File
- Legal Width Pedestal
- Open Back – Optional Back Panel Sold Separately
- Modular Top Required

NOTE: Finger Pull not Available

MODULAR PEDESTAL FILE/FILE 	14-3618PD2	18	35 1/4	28 1/4	-	-	125	13.6	W \$ 1784 PV \$ 2089
	14-3018PD2	18	29 1/4	28 1/4	-	-	105	11.6	W \$ 1694 PV \$ 1982
	14-2418PD2	18	23 1/4	28 1/4	-	-	85	9.5	W \$ 1618 PV \$ 1893

Description

- Locking
- File/File
- Legal Width Pedestal
- Open Back – Optional Back Panel Sold Separately
- Modular Top Required

NOTE: Finger Pull not Available

MODULAR PEDESTAL SHELL	Left	Right	W	D	H	K	R	Ship Wt	Cubic Ft	List Price
	14-3618PD3L	14-3618PD3R								
14-3018PD3L	14-3018PD3R	18	30	28 1/4	-	-	42	11.6	W \$ 726 PV \$ 850	

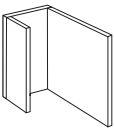

(Shown as right)

Description

- Used to Complete Single Pedestal Configuration
- Finished Back

For ordering options, see back of Madera Identification card at the beginning of section.

Item	Model No.	W	D	H	K	R	Ship Wt	Cubic Ft	List Price	
MODULAR PEDESTAL DOOR BOOKCASE	Hinged Left	Hinged Right								
	14-2418PD4L	14-2418PD4R	18	23 1/4	28 1/4	-	-	65	8.9	W \$ 663 PV \$ 775

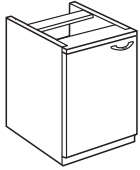
Description

- One Adjustable Shelf
- Open Back – Optional Back Panel Sold Separately
- Modular Top Required

Options: Specify & Add

Optional Locking	\$ 43
------------------	-------

NOTE: Finger Pull not Available

MODULAR PEDESTAL LATERAL FILE	14-2436LF1	36	23 1/4	28 1/4	-	-	154	17.5	W \$ 2002 PV \$ 2344
	14-2430LF1	30	23 1/4	28 1/4	-	-	128	14.9	W \$ 1949 PV \$ 2280

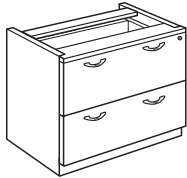
Description

- Lateral File/Lateral File
- Locking
- Anti-Tilt System
- Open Back – Optional Back Panel Sold Separately
- Modular Top Required

NOTE: Finger Pull not Available

MODULAR PEDESTAL MULTI-FILE	14-2436LF2	36	23 1/4	28 1/4	-	-	154	17.5	W \$ 2243 PV \$ 2625
	14-2430LF2	30	23 1/4	28 1/4	-	-	128	14.9	W \$ 2183 PV \$ 2554

Description

- Box/Box/File Over Lateral File
- Locking File Drawers Only
- Open Back – Optional Back Panel Sold Separately
- Modular Top Required

NOTE: Finger Pull not Available

For ordering options, see back of Madera Identification card at the beginning of section.

MADERA™ 1400/1600 SERIES

Modular Components

Item	Model No.	W	D	H	K	R	Ship Wt	Cubic Ft	List Price
MODULAR PEDESTAL DOOR BOOKCASE	14-2436DB	36	23 1/4	28 1/4	-	-	105	17.5	W \$ 1743 PV \$ 2039
	14-2430DB	30	23 1/4	28 1/4	-	-	87	14.9	W \$ 1696 PV \$ 1984

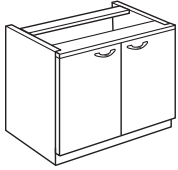
Description

- 13" Adjustable Shelf
- Open Back – Optional Back Panel Sold Separately
- Modular Top Required

Options: Specify & Add

Optional Locking	\$ 58
------------------	-------

NOTE: Finger Pull not Available

Item	Model No.	W	D	H	K	R	Ship Wt	Cubic Ft	List Price
MODULAR BACK PANEL	14-9628BP	96	3/4	28 1/4	-	-	115	5.0	W \$ 773 PV \$ 904
	14-9028BP	90	3/4	28 1/4	-	-	108	4.6	W \$ 753 PV \$ 881
	14-8428BP	84	3/4	28 1/4	-	-	101	4.3	W \$ 736 PV \$ 861
	14-7828BP	78	3/4	28 1/4	-	-	94	4.0	W \$ 706 PV \$ 826
	14-7228BP	72	3/4	28 1/4	-	-	86	3.7	W \$ 601 PV \$ 704
	14-6628BP	66	3/4	28 1/4	-	-	79	3.4	W \$ 582 PV \$ 681
	14-6028BP	60	3/4	28 1/4	-	-	72	3.0	W \$ 556 PV \$ 650
	14-5428BP	54	3/4	28 1/4	-	-	65	2.8	W \$ 520 PV \$ 608
	14-4828BP	48	3/4	28 1/4	-	-	55	2.5	W \$ 496 PV \$ 580
	14-4228BP	42	3/4	28 1/4	-	-	50	2.2	W \$ 469 PV \$ 549
	14-3628BP	36	3/4	28 1/4	-	-	45	2.0	W \$ 393 PV \$ 460
	14-3028BP	30	3/4	28 1/4	-	-	30	1.6	W \$ 367 PV \$ 429
	14-2428BP	24	3/4	28 1/4	-	-	24	1.4	W \$ 353 PV \$ 414
	14-1828BP	18	3/4	28 1/4	-	-	19	1.0	W \$ 342 PV \$ 399

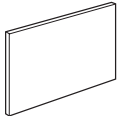

Description

- For Use as a Modesty Panel to Create Bridges, Returns, or Credenzas

Options: Specify & Add

1-GRMT Optional Top-Center Grommet	\$ 48
------------------------------------	-------

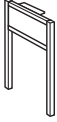
For ordering options, see back of Madera Identification card at the beginning of section.

Item	Model No.	W	D	H	K	R	Ship Wt	Cubic Ft	List Price
SEATED HEIGHT MODULAR PENINSULA SUPPORT 	01-2428HLV Single Mount Plate	24	1	28 1/4	-	-	20	1.4	\$ 502
	01-3028HLV Single Mount Plate	30	1	28 1/4	-	-	25	1.7	\$ 669
	01-3628HLV Single Mount Plate	36	1	28 1/4	-	-	30	2.0	\$ 680
	01-2428TLV Double Mount Plate	24	1	28 1/4	-	-	20	1.4	\$ 519
	01-3028TLV Double Mount Plate	24	1	28 1/4	-	-	25	1.7	\$ 690
	01-3628TLV Double Mount Plate	24	1	28 1/4	-	-	30	2.0	\$ 702

Description

- Metal End Support to Be Used with Modular Desk Tops at 30" High
- Select From 5 Powdercoat Finishes
- Double Mount Plate Required for Freestanding Table/Desk
- Recommended to Be Used with Vertical Profiles — D, E, X, Y

Options: Specify & Add

HIW Wood Insert	\$ 73
	PV \$ 84

SEATED HEIGHT MODULAR PENINSULA SUPPORT 	01-2428OL	24	2	28 1/4	-	-	20	1.8	\$ 667
	01-3028OL	30	2	28 1/4	-	-	25	2.3	\$ 681
	01-3628OL	36	2	28 1/4	-	-	30	2.7	\$ 698

Description

- Metal End Support to Be Used with Modular Desk Tops at 30" High
- Select From 5 Powdercoat Finishes
- Recommended to Be Used with Vertical Profiles — D, E, X, Y

SEATED HEIGHT MODULAR PENINSULA SUPPORT 	01-2428UL	24	2	28 1/4	-	-	20	1.8	\$ 710
	01-3028UL	30	2	28 1/4	-	-	25	2.3	\$ 726
	01-3628UL	36	2	28 1/4	-	-	30	2.7	\$ 739

Description

- Metal End Support to Be Used with Modular Desk Tops at 30" High
- Select From 5 Powdercoat Finishes
- Recommended to Be Used with Vertical Profiles — D, E, X, Y

For ordering options, see back of Madera Identification card at the beginning of section.

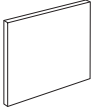
Item	Model No.	W	D	H	K	R	Ship Wt	Cubic Ft	List Price
 MODULAR END PANEL	14-2428EP	23 1/4	1 5/32	28 1/4	-	-	27	1.6	W \$ 378 PV \$ 441
	14-3028EP	29 1/4	1 5/32	28 1/4	-	-	34	1.6	W \$ 404 PV \$ 472
	14-3628EP	35 1/4	1 5/32	28 1/4	-	-	41	2.0	W \$ 432 PV \$ 506

Description

- End Panel for Worksurfaces to Create Desks, Returns, or Credenzas
- Required to be Used with a Back Panel

 MODULAR SUPPORT PANEL	14-2812SP	12	1 5/32	28 1/4	-	-	12	0.8	W \$ 245 PV \$ 286
---	-----------	----	--------	--------	---	---	----	-----	-----------------------

Description

- Used to Support Worksurfaces
- Required to be Used Perpendicular to Full Back Panels to Support Kneespace Areas Greater Than 60"

 MODULAR T SUPPORT	14-1010SP	10	10	28 1/4	-	-	12	0.9	W \$ 335 PV \$ 392
--	-----------	----	----	--------	---	---	----	-----	-----------------------

Description

- Used to Support Worksurfaces
- Required to be Used on Kneespace Areas of 60" or Greater Where Back Panels are Not Used

 MODULAR FILLER PANEL	14-2803FP	3	3/4	28 1/4	-	-	6	0.5	W \$ 204 PV \$ 239
--	-----------	---	-----	--------	---	---	---	-----	-----------------------

Description

- Used to Fill Gap Behind Modular Pedestals When Back Panels are Not Used

 STIFFENER BAR	01-00048SB	48	1 3/4	3/4	-	-	5	.3	\$ 163
	01-00060SB	60	1 3/4	3/4	-	-	8	.3	\$ 172

Description

- Reinforces Worksurfaces with Large Kneespace Widths
- Field Installed
- Recommended in Kneespaces 60" or Greater

For ordering options, see back of Madera Identification card at the beginning of section.

Item	Model No.	W	D	H	K	R	Ship Wt	Cubic Ft	List Price
EXECUTIVE "L" UNIT FULL PEDESTALS STEPPED FRONT	16-1	72	84	30	-	-	402	74.9	W/P \$ 5783 PV \$ 6765
Consists of:		Qty							
	16-3672LPS	1	• Left Pedestal Desk						W/P \$ 3500 PV \$ 4094
	16-2448RF	1	• Right Return						W/P \$ 2283 PV \$ 2671

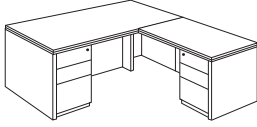

EXECUTIVE "U" UNIT BOW TOP DESK FULL PEDESTALS STEPPED FRONT	16-2	72	110	70	-	-	756	127.2	W/P \$ 10476 PV \$ 12257
Consists of:		Qty							
	16-4272LPS	1	• Bow Top Left Pedestal Desk						W/P \$ 4166 PV \$ 4875
	14-2448UF	1	• Bridge						W/P \$ 1067 PV \$ 1249
	16-2072RC	1	• Executive Single Right Ped Credenza						W/P \$ 2516 PV \$ 2943
	14-1572HU	1	• Hutch						W/P \$ 2727 PV \$ 3190

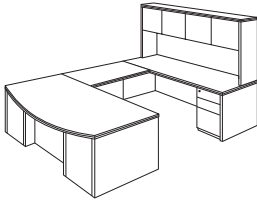

All pedestal desks shown as left.
 All returns shown as right.

For ordering options, see back of Madera Identification card at the beginning of section.

Item	Model No.	W	D	H	K	R	Ship Wt	Cubic Ft	List Price
EXECUTIVE "U" UNIT P-TOP	16-3	72	110	70	-	-	625	128.20	W/P \$ 9974 PV \$ 11670

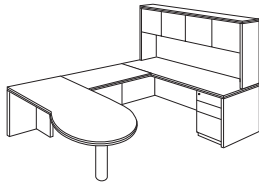

Consists of:	Qty		
14-4272PL	1	• Left P-Top Unit	W/P \$ 3664 PV \$ 4288
14-2448UF	1	• Bridge	W/P \$ 1067 PV \$ 1249
16-2072RC	1	• Executive Single Right Ped Credenza	W/P \$ 2516 PV \$ 2943
14-1572HU	1	• Hutch	W/P \$ 2727 PV \$ 3190

EXECUTIVE "U" UNIT D-TOP	16-4	72	104	30	-	-	231	88.80	W/P \$ 6264 PV \$ 7327
-----------------------------	------	----	-----	----	---	---	-----	-------	---------------------------

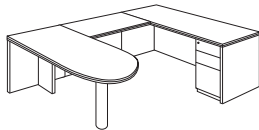

Consists of:	Qty		
14-3672DUL	1	• D-Top Unit	W/P \$ 2681 PV \$ 3135
14-2448UF	1	• Bridge	W/P \$ 1067 PV \$ 1249
16-2072RC	1	• Executive Single Right Ped Credenza	W/P \$ 2516 PV \$ 2943

All groups are shown as right U-groups.

For ordering options, see back of Madera Identification card at the beginning of section.

TACKBOARD: SURFACE MOUNTED HUTCHES - 21" TALL

Size	Model #	COM ydg	COM, Grade 1, 2 or 3 List Price	Grade 4 List Price	Grade 5 List Price	Grade 6 List Price	Grade 7 List Price	Grade 8 List Price	Grade 9 List Price	Grade 10 List Price
66"	TB-1466H	2.00	\$ 336	\$ 518	\$ 600	\$ 690	\$ 810	\$ 937	\$ 1090	\$ 1263
72"	TB-1472H	2.25	\$ 357	\$ 561	\$ 653	\$ 755	\$ 890	\$ 1033	\$ 1204	\$ 1399
78"	TB-1478H	2.50	\$ 397	\$ 624	\$ 726	\$ 840	\$ 989	\$ 1148	\$ 1339	\$ 1555
84"	TB-1484H	2.50	\$ 404	\$ 631	\$ 734	\$ 847	\$ 996	\$ 1156	\$ 1346	\$ 1562
90"	TB-1490H	2.75	\$ 425	\$ 674	\$ 787	\$ 912	\$ 1076	\$ 1251	\$ 1461	\$ 1698
96"	TB-1496H	3.00	\$ 446	\$ 717	\$ 841	\$ 977	\$ 1156	\$ 1347	\$ 1575	\$ 1835

NOTE: All tackboards 78" and longer are 2 pieces.

TACKBOARD: WALL MOUNTED HUTCHES - 21 7/8" TALL

Size	Model #	COM ydg	COM, Grade 1, 2 or 3 List Price	Grade 4 List Price	Grade 5 List Price	Grade 6 List Price	Grade 7 List Price	Grade 8 List Price	Grade 9 List Price	Grade 10 List Price
36"	TB-0136W	1.25	\$ 274	\$ 387	\$ 438	\$ 495	\$ 570	\$ 649	\$ 744	\$ 853

TASKLIGHTS - Includes 3 Wire Management Grommets

Model #	Size	Description	List Price
TL-0824	22 1/2" x 1 5/8" x 7/8"	84-LED, 7 Watts	\$ 234
TL-0848	47 1/2" x 1 5/8" x 7/8"	240-LED, 18 Watts	\$ 280

BOX DRAWER DIVIDER

	14-0316DV	15 7/32	1/4	3 1/2	-	-	1	0.5	\$ 72	
	For use in Legal Width Box Drawer									
	14-0315DV	14 5/32	1/4	3 1/2	-	-	1	0.5	\$ 67	
For use in Component Pedestal Box Drawer										
	14-0313DV	12 7/32	1/4	3 1/2	-	-	1	0.5	\$ 58	
For use in Letter Width Box Drawer										

Description

- Plastic Clips Mount Over Drawer Sides
- Frosted Divider

ResilienceTM

Casegoods Collection

How to Order

MODEL NO.	DESCRIPTION
38-4272DP1	Chassis Laminate YC
	Top Laminate CN
	Edge X
	Pull MBA

Order must be listed as shown, with Chassis Color and Top Color specified separately.



Specifications

LAMINATES

Exposed surfaces are produced from wood grained, patterned, and solid color laminates fused to a particle-board core. Each laminate offers lasting beauty, superior resistance to normal wear, and easy maintenance.

TOPS

HPL tops are 3-ply construction, 1 $\frac{3}{16}$ " thick with PVC rims. Tops are shaped on all four sides for complete design appeal. Tops are available in eleven wood-look laminates, one pattern laminate, and two different edge details.

CHASSIS CONSTRUCTION

Built to be reconfigurable, tops, end panels, and modesty panels are assembled using European-style mechanical fasteners and heavy-duty, 16-gauge joining brackets. Laminate parting rails assure a sturdy pedestal. All units are equipped with heavy-duty, adjustable glides to ensure proper leveling and compensate for uneven floors.

DRAWERS

All drawer fronts feature laminated fronts with banded edges. Fronts are 3-ply construction and $\frac{3}{4}$ " thick. Drawer sides and backs are constructed with $\frac{7}{16}$ " thick black MDF and $\frac{1}{8}$ " hardboard bottoms. Drawers feature 5-sided construction allowing for easy removal of drawer fronts.

DRAWER SUSPENSION

File drawers and box drawers feature high quality, black progressive full extension slides with precision steel ball bearings to ensure a smooth, quiet operation. All suspensions have a lifetime warranty.

FILING HARDWARE

All file drawers are standard with custom fitted filing systems designed to accommodate a variety of filing requirements. Desk file drawers provide legal filing or two rows of letter filing side to side. Credenza/Return file drawers provide legal or letter filing side to side.

LOCKING

All pedestals and files feature locking. Removable lock cylinders allow for units to be re-keyed at a later date if required. Units are shipped randomly keyed as standard. Lock cores match pull color.

CORD MANAGEMENT

Route power and data cables away from the worksurface through inherent grommet placement. Optional black grommets are standard in back panels of assembled returns, bridge units, kneespace credenzas, and hutch units. A grommet is standard in tops of corner units. Grommets may be ordered in the tops of desks, returns, bridge units, credenzas, and component work-surfaces. See page 290 for all optional grommet locations.

Undersurface tracks are available for additional cord management. Silver grommets are also available. See Accessories.



Laminate Modularity

Laminate Options

TOP OR CHASSIS



Sugar Maple
SM



Light Maple
LM

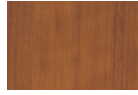

Classic Cherry
CC

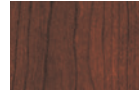

Yorkshire Cherry
YC



Jewel Mahogany
JM

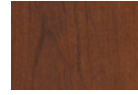

Williamsburg Cherry
WC



Golden Cherry
GC



New Age Oak
OK



Studio Teak
TK

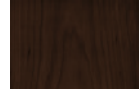

Espresso
EF

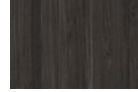

Asian Night
AS

TOP ONLY



Charcoal Nebula
CN

CHASSIS ONLY



Black
BL

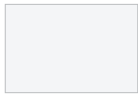

Designer White
WH

Edge Options



Flute
X



Square
Y

Pull Options



Aluminum Orbit
AOR



Pewter Waterfall
PTW



Pewter Arch
PTA



Black Orbit
BOR



Matte Black Waterfall
MBW



Matte Black Arch
MBA

COORDINATING PRODUCTS

Resilience Casegoods offers options to coordinate with Niche Conference.

INTERIOR DRAWER DIMENSIONS

RESILIENCE 3800 INTERIOR DRAWER DIMENSIONS

Item	Drawers	W	L	D
38-4272DP	Box	14 ⁵ / ₈	25 ¹ / ₄	3 ²¹ / ₃₂
38-3672DP	File	14 ⁵ / ₈	25 ¹ / ₄	8 ²⁹ / ₃₂
38-3066DP				
38-4272LP				
38-4272RP				
38-3672LP				
38-3672RP				
38-3066LP				
38-3066RP				
38-3618PD				
38-3018PD				
38-4278CLP	Box	14 ⁵ / ₈	19 ¹ / ₄	3 ²¹ / ₃₂
38-4278CRP	File	14 ⁵ / ₈	19 ¹ / ₄	8 ²⁹ / ₃₂
38-3672WC1				
38-3672WC2				
38-2442CLF				
38-2442CLR				
38-2448LF				
38-2448RF				
38-2472SC				
38-2472KC				
38-2466KC				
38-2472LC				
38-2472RC				
38-2466LC				
38-2466RC				
38-2418PD				
38-1872STL				
38-1872STR				
38-1824MP				
38-1824MP2	Top File	14 ⁵ / ₈	16 ³ / ₈	8 ²⁹ / ₃₂
	Btm File	14 ⁵ / ₈	19 ¹ / ₄	8 ²⁹ / ₃₂
38-2436L2	File	32 ⁵ / ₈	19 ¹ / ₄	8 ²⁹ / ₃₂
38-2436L3				
38-2436L4				
38-2436LF1				
38-2436TF				
38-2436QF				
38-3672VC	Box	32 ⁵ / ₈	19 ¹ / ₄	3 ²¹ / ₃₂
38-3672SU1	File	32 ⁵ / ₈	19 ¹ / ₄	8 ²⁹ / ₃₂
38-2436LF2	Box	14 ⁵ / ₈	19 ¹ / ₄	3 ²¹ / ₃₂
38-2436LF4	File	14 ⁵ / ₈	19 ¹ / ₄	8 ²⁹ / ₃₂
	Lat File	32 ⁵ / ₈	19 ¹ / ₄	8 ²⁹ / ₃₂
38-2122CD	Center	19 ⁵ / ₈	19 ¹ / ₈	1 ²⁹ / ₃₂
38-1622CD	Center	19 ⁵ / ₈	15 ¹ / ₈	1 ²⁹ / ₃₂

FILING CAPABILITIES

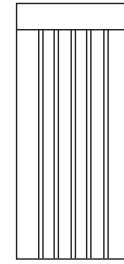
 14 ⁵/₈ x 25 ¹/₄

Legal Side to Side

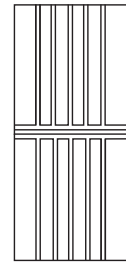

Letter Side to Side

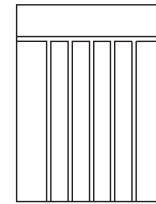
 14 ⁵/₈ x 19 ¹/₄

Legal Side to Side

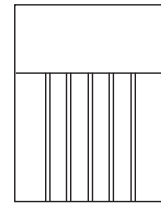

Letter Side to Side

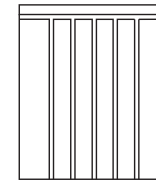
 14 ⁵/₈ x 16 ³/₈

Legal Side to Side

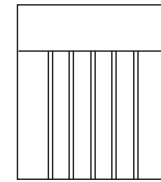

Letter Side to Side

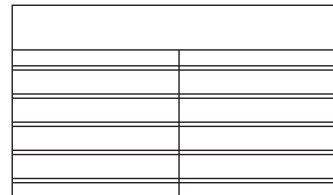
 32 ⁵/₈ x 19 ¹/₄

2 Rows Letter or Legal Front to Back

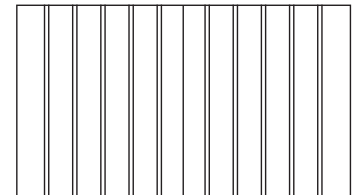

1 Row Letter or Legal Side to Side

GROMMET LOCATIONS

Grommets are standard in the back panels of returns, bridges, and credenzas. These units may be ordered without grommets at no additional charge. Please specify "NO GROMMET" on order.

Grommets are available on hutches in standard locations for task-light management at no additional charge. Please specify HUGRMT.

Desk grommets are available in standard locations. Please specify and add an upcharge of \$48 list for each grommet.

Specify grommet locations.

- GL - Grommet Left
- GC - Grommet Center
- GR - Grommet Right

Example: 38-3672DP2-GL-GR (Grommet Left, Grommet Right)

Standard grommet locations are available on cockpit units. Contact Customer Service for more information.

Grommets may be ordered in non-standard locations. Please call Customer Service to assist with how to order and additional lead time requirements.

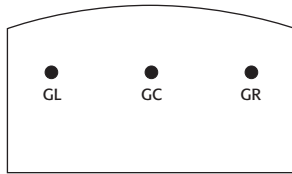

38-4272DP
 38-4272LP
 38-4272RP
 38-4272BWT
 38-3672BWT

GL/GR - 6" from ends, 27 1/4" from user side.
 GC - 27 1/4" from user side.

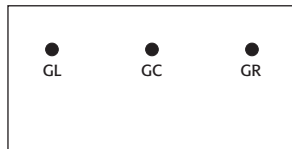

38-3672DP 38-3066DP
 38-3672LP 38-3066LP
 38-3672RP 38-3066RP
 38-3672TP 38-3066TP

GL/GR - 6" from ends, 27 1/4" from user side.
 GC - 27 1/4" from user side.



38-2418TP 38-2466KC1-2-3-4
 38-2430TP 38-2466LC1/RC1
 38-2436TP 38-2466RC2/LC2
 38-2436UF 38-2466TP
 38-2436UFH 38-2472KC1-2-3-4
 38-2442TP 38-2472RC1/LC1
 38-2442UF 38-2472RC2/LC2
 38-2442UFH 38-2472TP
 38-2448LF1/RF1 38-2478TP
 38-2448LF2/RF2 38-2484TP
 38-2448TP 38-2490TP
 38-2448UF 38-2496TP
 38-2448UFH 38-24102TP
 38-2454TP 38-24108TP
 38-2460TP

GL/GR - 6" from ends, 21 1/4" from user side.
 GC - 21 1/4" from user side.

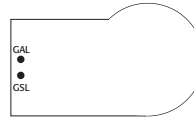
GROMMET LOCATIONS - CONTINUED

38-4272PR
 38-4272TR
 38-3672PR
 38-3672TR

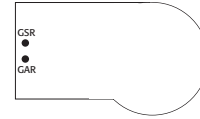

38-4272PL
 38-4272TL
 38-3672PL
 38-3672TL

GAL/GSL - 12" from approach or seated side, 6" from end.
 GSR/GAR - 12" from approach or seated side, 6" from end.



38-3672DUR
 38-3072DUR
 38-3066DUR
 38-3060DUR



38-3672DUL
 38-3672DR
 38-3072DUL
 38-3072DR
 38-3066DUL
 38-3066DR
 38-3060DUL

GAL/GSL - 12" from approach or seated side, 6" from end.
 GAR/GSR - 12" from approach or seated side, 6" from end.

LOCKING HUTCH DOORS

Locking doors are available on hutches. Please specify with locking and add \$71 list to the following units.

38-1472HD 38-1466HD

Please specify with locking and add \$58 list to the following units.

38-1436HD 38-1436WD

RESILIENCE LAMINATE OFFERING

Indiana Furniture has partnered with Pionite Decorative Laminates and Wilsonart International to provide a Customer Specified Laminate program.

- CSL can be specified for worksurfaces only. Chassis colors cannot be requested.
- Laminate sheen level not to exceed 60° for maximum durability of worksurfaces.
- Indiana Furniture reserves the right to decline a laminate which may not be suitable for application.
- Indiana Furniture assumes no responsibility for the durability, consistent coloration or any other performance characteristic of a customer specified laminate.
- Contact Customer Service with product list and specific laminate information to obtain a quote for pricing and lead time.

Pionite®
 Decorative Laminates
 CALL 1.800.PIONITE FOR SAMPLES

WILSONART
 INTERNATIONAL
 CALL 1.800.433.3222 FOR SAMPLES

Item	Model No.	W	D	H	K	R	Ship Wt	Cubic Ft	List Price
EXECUTIVE DOUBLE PED DESK BOW TOP	38-4272DP1	72	42-36	30	36	-	405	57.9	\$ 3146

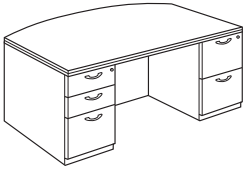
Description

- Bow Top
- Stepped Front
- Locking Pedestals
- Legal Width Pedestals
- Box/Box/File in Left Pedestal
- File/File in Right Pedestal

EXECUTIVE DOUBLE PED DESK BOW TOP	38-4272DP2	72	42-36	30	36	-	405	57.9	\$ 3146
--------------------------------------	------------	----	-------	----	----	---	-----	------	---------

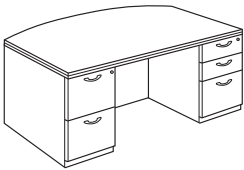

Description

- Bow Top
- Stepped Front
- Locking Pedestals
- Legal Width Pedestals
- File/File in Left Pedestal
- Box/Box/File in Right Pedestal

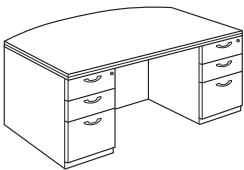
EXECUTIVE DOUBLE PED DESK BOW TOP	38-4272DP4	72	42-36	30	36	-	405	57.9	\$ 3146
--------------------------------------	------------	----	-------	----	----	---	-----	------	---------

Description

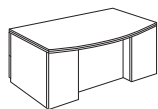
- Bow Top
- Stepped Front
- Locking Pedestals
- Legal Width Pedestals
- Box/Box/File in Pedestals



Stepped Front

For ordering options, see back of Resilience Identification card at the beginning of section.

For grommet options, see page 290.

For center drawer options, see page 313.

Item	Model No.	W	D	H	K	R	Ship Wt	Cubic Ft	List Price
EXECUTIVE DOUBLE PED DESK RECTANGULAR TOP	38-3672DP1	72	36	30	36	-	400	50.0	\$ 2910
	38-3066DP1	66	30	30	30	-	321	38.7	\$ 2776

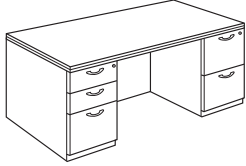
Description

- Locking Pedestals
- Stepped Front
- Legal Width Pedestals
- Box/Box/File in Left Pedestal
- File/File in Right Pedestal

EXECUTIVE DOUBLE PED DESK RECTANGULAR TOP	38-3672DP2	72	36	30	36	-	400	50.0	\$ 2910
	38-3066DP2	66	30	30	30	-	321	38.7	\$ 2776

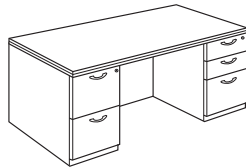

Description

- Locking Pedestals
- Stepped Front
- Legal Width Pedestals
- File/File in Left Pedestal
- Box/Box/File in Right Pedestal

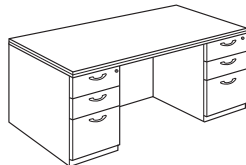
EXECUTIVE DOUBLE PED DESK RECTANGULAR TOP	38-3672DP4	72	36	30	36	-	400	50.0	\$ 2910
	38-3066DP4	66	30	30	30	-	321	38.7	\$ 2776

Description

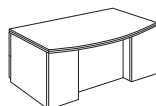
- Locking Pedestals
- Stepped Front
- Legal Width Pedestals
- Box/Box/File in Pedestals



Stepped Front

For ordering options, see back of Resilience Identification card at the beginning of section.

For grommet options, see page 290.

For center drawer options, see page 313.

Item	Model No.	W	D	H	K	R	Ship Wt	Cubic Ft	List Price	
EXECUTIVE SINGLE PED DESK BOW TOP	Left Ped	Right Ped								
	38-4272LP1	38-4272RP1	72	42-36	30	30	-	278	60.0	\$ 2658

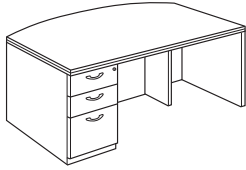
Description

- Bow Top
- Stepped Front
- Locking Pedestal
- Legal Width Pedestal
- Box/Box/File in Pedestal

EXECUTIVE SINGLE PED DESK RECTANGULAR TOP	Left Ped	Right Ped								
	38-3672LP1	38-3672RP1	72	36	30	30	-	271	52.1	\$ 2311
	38-3066LP1	38-3066RP1	66	30	30	24	-	247	39.0	\$ 2171

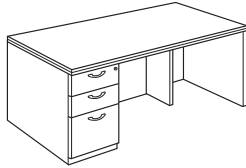
Description

- Locking Pedestal
- Stepped Front
- Legal Width Pedestal
- Box/Box/File in Pedestal

COCKPIT DESK BOW TOP	Left Ped	Right Ped								
	38-4278CLP1	38-4278CRP1	78	42-36	30	36	-	350	62.6	\$ 2843

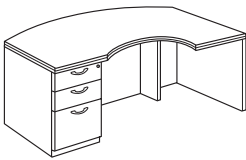
Description

- Bow Top
- Locking Pedestal
- Legal Width Pedestal
- Box/Box/File in Pedestal

NOTE: Tops are non reconfigurable.

COCKPIT SHELL DESK BOW TOP	Left Ped	Right Ped								
	38-4278CLSH	38-4278CRSH	78	42-36	30	54	-	260	62.6	\$ 2298

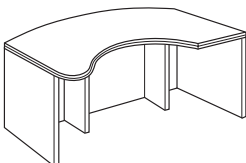
Description

- Bow Top
- Desk Shell

NOTE: Tops are non reconfigurable.

All pedestal desks shown as left.

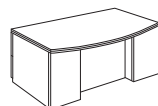

Stepped Front

For ordering options, see back of Resilience Identification card at the beginning of section.

For grommet options, see page 290.

For center drawer options, see page 313.

Item	Model No.	W	D	H	K	R	Ship Wt	Cubic Ft	List Price
------	-----------	---	---	---	---	---	---------	----------	------------

P-TOP WITH END SUPPORT CYLINDER BASE	Left Ped	Right Ped								
	38-4272PL	38-4272PR	72	42-36	30	-	-	173	57.9	\$ 1871
	38-3672PL	38-3672PR	72	36-30	30	-	-	170	50.0	\$ 1744

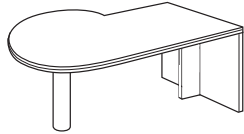
Description

- End Panel Support
- Metal Cylinder Base - 4 1/2" Diameter. Must Specify: Black or Aluminum.

Options: Specify & Add

38-HMD	Optional Half Modesty Panel	\$	66
38-FMD	Optional Full Modesty Panel	\$	116

NOTE: 38-4272PL/PR - For center drawer option with a modesty panel option use 38-1622CD on page 313.

NOTE: 38-3672PL/PR - Center drawer and keyboard options are not applicable with modesty panel option.

NOTE: Not recommended for freestanding use.

D-TOP WITH END SUPPORT CYLINDER BASE	Left Top	Right Top								
	38-3672DUL	38-3672DUR	72	36	30	-	-	170	50.0	\$ 1610
	38-3072DUL	38-3072DUR	72	30	30	-	-	165	42.1	\$ 1463
	38-3066DUL	38-3066DUR	66	30	30	-	-	150	38.7	\$ 1397
	38-3060DUL	38-3060DUR	60	30	30	-	-	135	35.3	\$ 1337

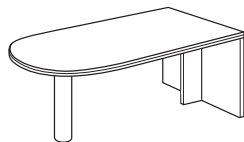
Description

- End Panel Support
- Metal Cylinder Base - 4 1/2" Diameter. Must Specify: Black or Aluminum.

Options: Specify & Add

		72"	66"	60"
38-HMD	Optional Half Modesty Panel	\$ 66	\$ 62	\$ 57
38-FMD	Optional Full Modesty Panel	\$ 116	\$ 105	\$ 92

NOTE: 38-3672DUL/38-3672DUR - For center drawer option with a modesty panel option use 38-1622CD on page 313.

NOTE: 38-3072DUL/38-3072DUR/38-3066DUL/38-3066DUR/38-3060DUL/38-3060DUR - Center drawer and keyboard options are not applicable with modesty panel option.

NOTE: Not recommended for freestanding use.

For ordering options, see back of Resilience Identification card at the beginning of section.

For grommet options, see page 290.

For center drawer options, see page 313.

Item	Model No.	W	D	H	K	R	Ship Wt	Cubic Ft	List Price	
EXECUTIVE RETURN FILE/FILE	Left Ped									
	Right Ped									
	38-2448LF2	38-2448RF2	48	24	30	30	-	150	24.2	\$ 1645

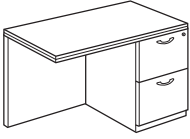
Description

- Locking Pedestal
- Legal Width Pedestal
- File/File in Pedestal
- Grommet in Back Panel

EXECUTIVE RETURN BOX/BOX/FILE	Left Ped									
	Right Ped									
	38-2448LF1	38-2448RF1	48	24	30	30	-	150	24.2	\$ 1645

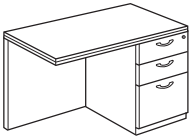
Description

- Locking Pedestal
- Legal Width Pedestal
- Box/Box/File in Pedestal
- Grommet in Back Panel

COCKPIT RETURN FILE/FILE	Left Ped									
	Right Ped									
	38-2442CLF2	38-2442CRF2	42	24	30	24	-	150	24.2	\$ 1736

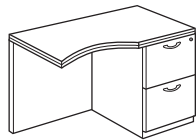
Description

- Locking Pedestal
- Legal Width Pedestal
- File/File in Pedestal
- Grommet in Back Panel

NOTE: Tops are non reconfigurable.

COCKPIT RETURN BOX/BOX/FILE	Left Ped									
	Right Ped									
	38-2442CLF1	38-2442CRF1	42	24	30	24	-	150	24.2	\$ 1736

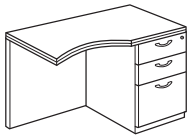
Description

- Locking Pedestal
- Legal Width Pedestal
- Box/Box/File in Pedestal
- Grommet in Back Panel

NOTE: Tops are non reconfigurable.

All returns shown as right.

For ordering options, see back of Resilience Identification card at the beginning of section.

For grommet options, see page 290.

For center drawer options, see page 313.

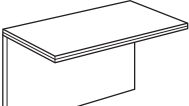
Item	Model No.	W	D	H	K	R	Ship Wt	Cubic Ft	List Price
EXECUTIVE BRIDGE FULL MODESTY 	38-2448UF	48	24	30	48	-	79	6.4	\$ 849
	38-2442UF	42	24	30	42	-	74	4.6	\$ 807
	38-2436UF	36	24	30	36	-	68	4.0	\$ 732

Description

- Grommet in Back Panel
- Hinged Back Panel

NOTE: Kneespace options can not be factory installed.

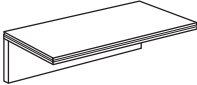
EXECUTIVE BRIDGE HALF MODESTY 	38-2448UFH	48	24	11	48	-	59	6.4	\$ 739
	38-2442UFH	42	24	11	42	-	54	4.6	\$ 720
	38-2436UFH	36	24	11	36	-	48	4.0	\$ 646

Description

- Hinged Back Panel

NOTE: Keyboards can not be factory installed.

COCKPIT BRIDGE 	38-2420CUF	20	24	30	20	-	60	2.3	\$ 664
---	------------	----	----	----	----	---	----	-----	--------

Description

- Grommet in Back Panel
- Hinged Back Panel

NOTE: Kneespace options are not applicable.

COCKPIT BRIDGE HALF MODESTY 	38-2420CUFH	20	24	11	20	-	40	2.3	\$ 623
---	-------------	----	----	----	----	---	----	-----	--------

Description

- Hinged Back Panel

NOTE: Kneespace options are not applicable.

For ordering options, see back of Resilience Identification card at the beginning of section.

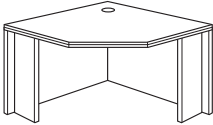
Item	Model No.	W	D	H	K	R	Ship Wt	Cubic Ft	List Price
CORNER UNIT 	38-4242CU Connects to 24" Deep Worksurfaces	42	42	30	25 1/2	-	140	36.0	\$ 1391
	38-3636CU Connects to 24" Deep Worksurfaces	36	36	30	17	-	115	26.8	\$ 1109
	38-424230CU Connects to 30" Deep Worksurfaces	42	42	30	17	-	138	35.6	\$ 1551

Description

- Freestanding Support Unit
- Grommet in Top

NOTE: Not all keyboards will fit the 38-3636CU and 38-424230CU. Recommended keyboards are 1-KCWR, 1-KCPR, and 1-KC.

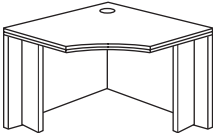
COCKPIT CORNER UNIT 	38-3636CCU Connects to 24" Deep Worksurfaces	36	36	30	17	-	116	26.6	\$ 1178
--	---	----	----	----	----	---	-----	------	---------

Description

- Freestanding Support Unit
- Grommet in Top

NOTE: Not all keyboards will fit this unit. Recommended keyboards are 1-KCWR, 1-KCPR, and 1-KC.

For ordering options, see back of Resilience Identification card at the beginning of section.

For center drawer options, see page 313.

Item	Model No.	W	D	H	K	R	Ship Wt	Cubic Ft	List Price	
EXTENDED CORNER UNIT ANGLED	Left Ped									
	Right Ped									
	38-3672ECL	38-3672ECR	72	36-24	30	-	-	195	50.0	\$ 1714

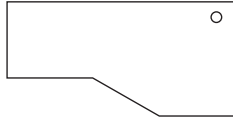
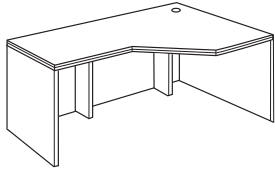
Description

- Connects to 24" Deep Component Worksurfaces and Returns
- Grommet in Top

Item	Model No.	W	D	H	K	R	Ship Wt	Cubic Ft	List Price	
EXTENDED COCKPIT CORNER UNIT CURVED	Left Ped									
	Right Ped									
	38-3672ECL1	38-3672ECR1	72	36-24	30	-	-	195	50.0	\$ 1714

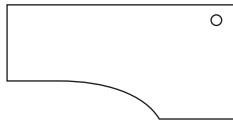
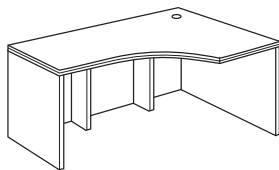

Description

- Connects to 24" Deep Component Worksurfaces and Returns
- Grommet in Top

For ordering options, see back of Resilience Identification card at the beginning of section.

For center drawer options, see page 313.

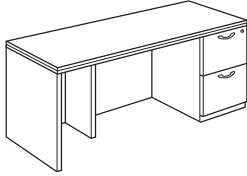
Item	Model No.	W	D	H	K	R	Ship Wt	Cubic Ft	List Price	
EXECUTIVE CREENZA FILE/FILE	Left Ped	Right Ped								
	38-2472LC2	38-2472RC2	72	24	30	30	-	240	35.6	\$ 1964
	38-2466LC2	38-2466RC2	66	24	30	24	-	230	31.5	\$ 1928

Description

- Locking Pedestal
- Legal Width Pedestal
- File/File in Pedestal
- Grommet in Back Panel

Item	Model No.	W	D	H	K	R	Ship Wt	Cubic Ft	List Price	
EXECUTIVE CREENZA BOX/BOX/FILE	Left Ped	Right Ped								
	38-2472LC1	38-2472RC1	72	24	30	30	-	240	35.6	\$ 1964
	38-2466LC1	38-2466RC1	66	24	30	24	-	230	31.5	\$ 1928

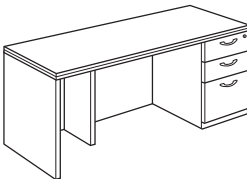
Description

- Locking Pedestal
- Legal Width Pedestal
- Box/Box/File in Pedestal
- Grommet in Back Panel

All credenzas shown as right.

For ordering options, see back of Resilience Identification card at the beginning of section.

For grommet options, see page 290.

For center drawer options, see page 313.

Item	Model No.	W	D	H	K	R	Ship Wt	Cubic Ft	List Price
TRANSACTION RISER FOR DESKS/CREDENZAS	38-1472TR For Use with 72" Wide Desks Only	72	14	12	-	-	75	10.9	\$ 844
	38-1466TR For Use with 66" Wide Desks Only	66	14	12	-	-	66	10.0	\$ 816

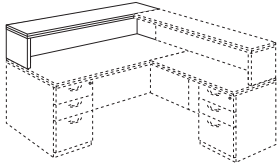
Description

- Freestanding Riser for Desks or Credenzas
- May Be Used in Conjunction with Return Risers or Bridge Risers

TRANSACTION RISER FOR RETURNS	Left Ped	Right Ped	W	D	H	K	R	Ship Wt	Cubic Ft	List Price
	38-1470LU For Use with 36" Desks and 48" Returns	38-1470RU	70	14	12	-	-	50	10.2	\$ 826
38-1464LU For Use with 30" Desks and 48" Returns	38-1464RU	64	14	12	-	-	45	9.1	\$ 782	

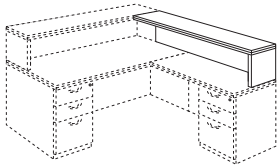
Description

- Must Be Used in Conjunction with a Desk Riser

TRANSACTION RISER FOR BRIDGES	38-1480BU For Use with 36" Desks, 48" Bridge, and Credenza	80	14	12	-	-	50	4.8	\$ 879
	38-1468BU For Use with 30" Desks, 42" Bridge, and Credenza	68	14	12	-	-	45	4.1	\$ 776

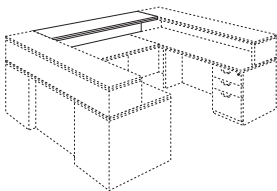
Description

- Must Be Used in Conjunction with Two Desk/Credenza Risers

For ordering options, see back of Resilience Identification card at the beginning of section.

For grommet options, see page 290.

Item	Model No.	W	D	H	K	R	Ship Wt	Cubic Ft	List Price
STORAGE CREDENZA	38-2472SC1	72	24	30	-	-	335	35.6	\$ 3352

Description

- Locking Pedestals
- Legal Width Pedestals
- Box/Box/File in Left Pedestal
- File/File in Right Pedestal
- Adjustable Storage Shelf Behind Doors

STORAGE CREDENZA	38-2472SC2	72	24	30	-	-	335	35.6	\$ 3352
------------------	------------	----	----	----	---	---	-----	------	---------

Description

- Locking Pedestals
- Legal Width Pedestals
- File/File in Left Pedestal
- Box/Box/File in Right Pedestal
- Adjustable Storage Shelf Behind Doors

STORAGE CREDENZA	38-2472SC3	72	24	30	-	-	335	35.6	\$ 3352
------------------	------------	----	----	----	---	---	-----	------	---------

Description



- Locking Pedestals
- Legal Width Pedestals
- File/File in Pedestals
- Adjustable Storage Shelf Behind Doors

STORAGE CREDENZA	38-2472SC4	72	24	30	-	-	335	35.6	\$ 3352
------------------	------------	----	----	----	---	---	-----	------	---------

Description

- Locking Pedestals
- Legal Width Pedestals
- Box/Box/File in Pedestals
- Adjustable Storage Shelf Behind Doors

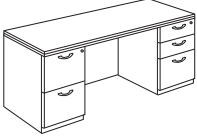
For ordering options, see back of Resilience Identification card at the beginning of section.

Item	Model No.	W	D	H	K	R	Ship Wt	Cubic Ft	List Price	
KNEESPACE CREDENZA 	38-2472KC1	72	24	30	36	-	310	35.6	\$ 2607	
	38-2466KC1	66	24	30	30	-	300	31.5	\$ 2570	
Description <ul style="list-style-type: none"> • Locking Pedestals • Legal Width Pedestals • Box/Box/File in Left Pedestal • File/File in Right Pedestal • Grommet in Back Panel 										
KNEESPACE CREDENZA 	38-2472KC2	72	24	30	36	-	310	35.6	\$ 2607	
	38-2466KC2	66	24	30	30	-	300	31.5	\$ 2570	
Description <ul style="list-style-type: none"> • Locking Pedestals • Legal Width Pedestals • File/File in Left Pedestal • Box/Box/File in Right Pedestal • Grommet in Back Panel 										
KNEESPACE CREDENZA 	38-2472KC3	72	24	30	36	-	310	35.6	\$ 2607	
	38-2466KC3	66	24	30	30	-	300	31.5	\$ 2570	
Description <ul style="list-style-type: none"> • Locking Pedestals • Legal Width Pedestals • File/File in Pedestals • Grommet in Back Panel 										
KNEESPACE CREDENZA 	38-2472KC4	72	24	30	36	-	310	35.6	\$ 2607	
	38-2466KC4	66	24	30	30	-	300	31.5	\$ 2570	
Description <ul style="list-style-type: none"> • Locking Pedestals • Legal Width Pedestals • Box/Box/File in Pedestals • Grommet in Back Panel 										

For ordering options, see back of Resilience Identification card at the beginning of section.

For center drawer options, see page 313.

Item	Model No.	W	D	H	K	R	Ship Wt	Cubic Ft	List Price
FOUR DRAWER LATERAL FILE	38-2436L4	36	24	54 1/2	-	-	310	33.1	\$ 2696

Description

- Locking Drawers
- Anti-Tilt System
- File Drawers Provide Legal or Letter Filing

THREE DRAWER LATERAL FILE	38-2436L3	36	24	42	-	-	237	26.2	\$ 2266
------------------------------	-----------	----	----	----	---	---	-----	------	---------

Description

- Locking Drawers
- Anti-Tilt System
- File Drawers Provide Legal or Letter Filing

TWO DRAWER LATERAL FILE	38-2436L2	36	24	30	-	-	185	17.9	\$ 1675
----------------------------	-----------	----	----	----	---	---	-----	------	---------

Description

- Locking Drawers
- Anti-Tilt System
- File Drawers Provide Legal or Letter Filing

For ordering options, see back of Resilience Identification card at the beginning of section.

Item	Model No.	W	D	H	K	R	Ship Wt	Cubic Ft	List Price
MOBILE PEDESTAL BOX/BOX/FILE	38-1824MP	18	23	28 1/2	-	-	112	9.3	\$ 1137

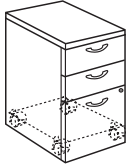
Description

- Locking Pedestal
- Legal Width Pedestal
- Box/Box/File in Pedestal
- Casters Allow for Easy Moving
- Fits Underneath 30" H Worksurfaces

MOBILE PEDESTAL FILE/FILE	38-1824MP2	18	23	28 1/2	-	-	112	9.3	\$ 1137
------------------------------	------------	----	----	--------	---	---	-----	-----	---------

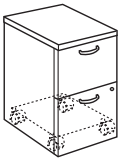
Description

- Locking Pedestal
- Legal Width Pedestal
- File/File in Pedestal
- Casters Allow for Easy Moving
- Fits Underneath 30" H Worksurfaces

For ordering options, see back of Resilience Identification card at the beginning of section.

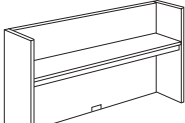
Item	Model No.	W	D	H	K	R	Ship Wt	Cubic Ft	List Price
SURFACE MOUNT OPEN HUTCH 	38-1472HN	72	14	40 ¹³ / ₁₆	-	-	180	30.7	\$ 695
	38-1466HN	66	14	40 ¹³ / ₁₆	-	-	165	27.1	\$ 650
	38-1436HN	36	14	40 ¹³ / ₁₆	-	-	105	16.7	\$ 501

Description

- Grommet in Back Panel
- 24 ¹¹/₁₆" Clearance Below Shelf

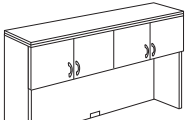
Item	Model No.	W	D	H	K	R	Ship Wt	Cubic Ft	List Price
SURFACE MOUNT DOOR HUTCH 	38-1472HD	72	14	42	-	-	207	30.7	\$ 1764
	38-1466HD	66	14	42	-	-	238	27.1	\$ 1722
	38-1436HD	36	14	42	-	-	108	16.7	\$ 1142

Description

- Storage Behind Four Hinged Doors
- Grommet in Back Panel
- 24 ¹¹/₁₆" Clearance Below Doors

For ordering options, see back of Resilience Identification card at the beginning of section.

For tackboard and tasklights, see page 330.

Item	Model No.	W	D	H	K	R	Ship Wt	Cubic Ft	List Price
OPEN STORAGE WALL MOUNT HUTCH	38-1436WN	36	14	16 1/8	-	-	50	6.6	\$ 443

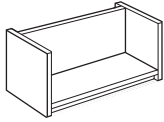
Description

- Open Storage
- Mounts to Wall with Mounting Bracket Included

NOTE: Indiana Furniture will not be liable for wall mount hutch units that are not properly installed.

WALL MOUNT HUTCH	38-1436WD	36	14	17 5/16	-	-	65	6.6	\$ 982
------------------	-----------	----	----	---------	---	---	----	-----	--------

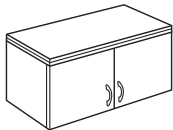
Description

- Storage Behind Two Hinged Doors
- Mounts to Wall with Mounting Bracket Included

NOTE: Indiana Furniture will not be liable for wall mount hutch units that are not properly installed.

OPEN STORAGE CORNER HUTCH	38-4242CH	42	42	40 13/16	-	-	140	48.2	\$ 893
	For Use on 42" Corner Units								
	38-3636CH	36	36	40 13/16	-	-	130	36.0	\$ 844
	For Use on 36" Corner Units								

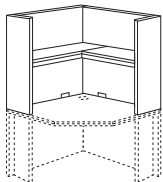
Description

- Storage Shelves
- Two Grommets

For ordering options, see back of Resilience Identification card at the beginning of section.

For tackboard and tasklights, see page 330.

Item	Model No.	W	D	H	K	R	Ship Wt	Cubic Ft	List Price
TOP UNIT BOOKCASE	38-1436TU One Adjustable Shelf	36	14	42	-	-	125	17.0	\$ 873

Description

- Fixed Bottom Shelf
- 3/4" Thick Shelves
- 13 1/2" Clearance Below Fixed Shelf

1/4 ROUND BOOKCASES	38-1472QR Four Adjustable Shelves - One Fixed Shelf	14	14	71 1/2	-	-	73	10.9	\$ 1087
	38-2430QR One Adjustable Shelf	24	24	29 15/32	-	-	95	12.0	\$ 953

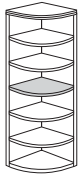
Description

- 3/4" Thick Shelves

BOOKCASES	38-3672BC Three Adjustable Shelves - One Fixed Shelf	36	14	71 1/2	-	-	166	26.8	\$ 1202
	38-3660BC Three Adjustable Shelves	36	14	59 1/2	-	-	139	22.4	\$ 1035
	38-3642BC Two Adjustable Shelves	36	14	42	-	-	106	16.4	\$ 946
	38-3630BC One Adjustable Shelf	36	14	30	-	-	85	11.1	\$ 849

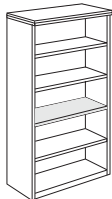
Description

- 3/4" Thick Shelves

For ordering options, see back of Resilience Identification card at the beginning of section.

Item	Model No.	W	D	H	K	R	Ship Wt	Cubic Ft	List Price
STORAGE TOWER	Hinged Left	Hinged Right							
	38-1418HL1	38-1418HR1	18	14	42	-	-	80	9.7

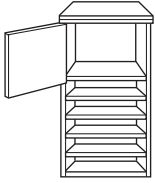
Description

- Storage Behind Door
- Four Adjustable Shelves

STORAGE TOWER	Hinged Left	Hinged Right								
	38-1418HL2	38-1418HR2	18	14	42	-	-	80	9.7	\$ 900

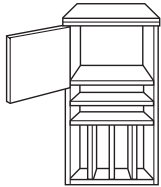
Description

- Storage Behind Door
- One Adjustable Shelf
- Horizontal and Vertical Storage

PORTABLE TOWER UNIT	38-1418HH	18	12 1/4	22	-	-	51	4.4	\$ 546
---------------------	-----------	----	--------	----	---	---	----	-----	--------

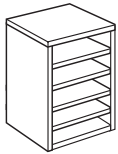
Description

- Four Adjustable Shelves

PORTABLE TOWER UNIT	38-1418HV	18	12 1/4	22	-	-	51	4.4	\$ 533
---------------------	-----------	----	--------	----	---	---	----	-----	--------

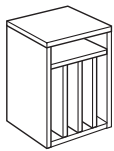
Description

- Horizontal and Vertical Storage

For ordering options, see back of Resilience Identification card at the beginning of section.

Item	Model No.	W	D	H	K	R	Ship Wt	Cubic Ft	List Price	
STORAGE	Hinged Left									
	Hinged Right									
	38-1872STL	38-1872STR	18	24	71 1/2	-	-	160	22.1	\$ 2015

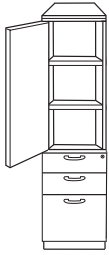

Description

- Top Section Includes Two Adjustable Shelves Behind Door
- Bottom Section Box/Box/File
- Locking Drawers

STORAGE UNIT	38-3672SU2	36	24	71 1/2	-	-	300	42.0	\$ 2386
--------------	------------	----	----	--------	---	---	-----	------	---------



Description

- Top Section Includes Two Adjustable Shelves Behind Doors
- Bottom Section File/File
- File Drawers Provide Legal or Letter Filing
- Locking Drawers

For ordering options, see back of Resilience Identification card at the beginning of section.

Item	Model No.	W	D	H	K	R	Ship Wt	Cubic Ft	List Price
VIDEO CABINET BOX/BOX/FILE	38-3672VC	36	24	71 1/2	-	-	300	42.0	\$ 2511

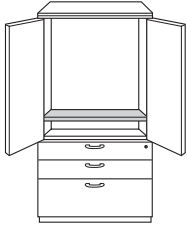

Description

- Top Section Includes an AV Shelf Behind Doors
- Bottom Section Box/Box/File with Letter or Legal Filing Capabilities
- Holds up to 27" TV
- 170° Hinge on Doors
- Grommet in Back Panel
- Locking Drawers

Options: Specify & Add

1-2516TV	Optional Factory Installed Slide Out and Swivel TV Tray	\$ 453
----------	---	--------

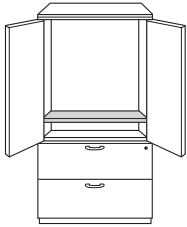
VIDEO CABINET FILE/FILE	38-3672VC1	36	24	71 1/2	-	-	300	42.0	\$ 2518
----------------------------	------------	----	----	--------	---	---	-----	------	---------



Description

- Top Section Includes an AV Shelf Behind Doors
- Bottom Section File/File with Letter or Legal Filing Capabilities
- Holds up to 27" TV
- 170° Hinge on Doors
- Grommet in Back Panel
- Locking Drawers

Options: Specify & Add

1-2516TV	Optional Factory Installed Slide Out and Swivel TV Tray	\$ 453
----------	---	--------

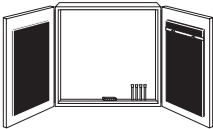
VISUAL BOARD	38-4848VB	48	5	48	-	-	150	12.2	\$ 1876
--------------	-----------	----	---	----	---	---	-----	------	---------

Description

- Tackboard on Each Door is Standard in Black Fabric Unless Specified
- Price Valid for Fabric Grades 1, 2, and 3
- Display Rail with Adjustable Hooks for Flipchart
- Flipchart
- Magnetic Porcelain Non-Glare Writing Surface
- Set of Four Dry Markers and Eraser
- Shipped with Appropriate Rails for Mounting

Options: Specify & Add	Grade 4	Grade 5	Grade 6	Grade 7	Grade 8	Grade 9	Grade 10
Tackboard	\$181	\$ 263	\$ 354	\$ 473	\$ 601	\$ 753	\$ 926
1-PS	Optional Factory Installed Projection Screen						\$ 667

NOTE: Visual Boards available only in squared edge and chassis colors.

NOTE: Indiana Furniture will not be liable for visual boards that are not properly installed.

For ordering options, see back of Resilience Identification card at the beginning of section.

Item	Model No.	W	D	H	K	R	Ship Wt	Cubic Ft	List Price	
WARDROBE/STORAGE	Hinged Left									
	Hinged Right									
	38-1872WL	38-1872WR	18	24	71 1/2	-	-	160	22.1	\$ 1516

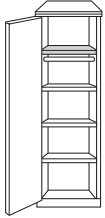
Description

- Fixed Top Shelf
- Coat Rod Under Fixed Shelf
- Three Adjustable Shelves can be Removed for Wardrobe Application

WARDROBE/STORAGE	38-3672WC	36	24	71 1/2	-	-	354	43.4	\$ 2577
------------------	-----------	----	----	--------	---	---	-----	------	---------

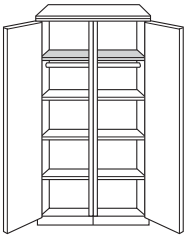
Description

- Two Doors
- Fixed Top Shelf Behind Each Door
- Coat Rod Under Fixed Shelf
- Three Adjustable Shelves Behind Each Door can be Removed for Wardrobe Application

WARDROBE/STORAGE	38-3672WC1	36	24	71 1/2	-	-	354	43.4	\$ 2653
------------------	------------	----	----	--------	---	---	-----	------	---------

Description

- Right Side - Fixed Top Shelf, Coat Rod, and Three Adjustable Shelves
- Left Side - Top Storage with Two Adjustable Shelves, Bottom Locking Box/Box/File

WARDROBE/STORAGE	38-3672WC2	36	24	71 1/2	-	-	354	43.4	\$ 2653
------------------	------------	----	----	--------	---	---	-----	------	---------

Description

- Right Side - Top Storage with Two Adjustable Shelves, Bottom Locking Box/Box/File
- Left Side - Fixed Top Shelf, Coat Rod, and Three Adjustable Shelves

For ordering options, see back of Resilience Identification card at the beginning of section.

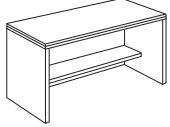
Item	Model No.	W	D	H	K	R	Ship Wt	Cubic Ft	List Price
COMPUTER WORK TABLE 	38-2454CW	54	24	30	52	-	135	25.9	\$ 1142
	38-2448CW	48	24	30	46	-	125	23.1	\$ 1060
	38-2436CW	36	24	30	34	-	115	17.6	\$ 900
	38-2430CW	30	24	30	28	-	105	14.8	\$ 864

Description

- Fixed Shelf
- Grommet in Back Panel

PRINTER TABLE	38-2436PT	36	24	30	-	-	125	17.6	\$ 1035
----------------------	-----------	----	----	----	---	---	-----	------	---------

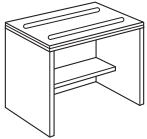

Description

- Fixed Shelf for Paper Feed or Paper Catch
- Accommodates Various Size Printers
- Two Paper Slots

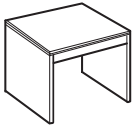
LAMP TABLE	38-2430LT	30	24	22	-	-	75	2.5	\$ 821
-------------------	-----------	----	----	----	---	---	----	-----	--------

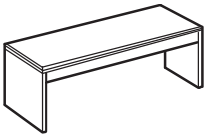

MAGAZINE TABLE	38-2448MT	48	24	16	-	-	85	4.0	\$ 960
-----------------------	-----------	----	----	----	---	---	----	-----	--------



For ordering options, see back of Resilience Identification card at the beginning of section.

Item	Model No.	W	D	H	K	R	Ship Wt	Cubic Ft	List Price
CENTER DRAWER	38-2122CD	22	21	2 3/4	-	-	12	1.9	\$ 267
	38-1622CD	22	16	2 3/4	-	-	7	1.3	\$ 148
For Use with 36" D-Top Units and 42" P-Top Units with Modesty Panels									
Description									
• Center Drawer									
Options: Specify & Add									
Factory Installed									\$ 130

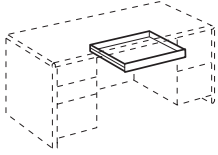

CIRCULAR TABLE	38-4848CT	48	48	1 3/16	-	-	63	5.7	\$ 1130
	Accommodates 5 Chairs								
	38-4242CT	42	42	1 3/16	-	-	40	4.4	\$ 1080
Accommodates 4 Chairs									
	38-3636CT	36	36	1 3/16	-	-	37	3.1	\$ 821
	Accommodates 3 Chairs								

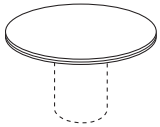
Description

- Single Base Required, See Page 314

For ordering options, see back of Resilience Identification card at the beginning of section.

Item	Model No.	W	D	H	K	R	Ship Wt	Cubic Ft	List Price
CYLINDER BASE	01-2020CB For Use on 48" and 42" Round Tables	20	20	28 1/2	-	-	134	11.1	\$ 977
	01-1616CB For Use on 36" Round Table	16	16	28 1/2	-	-	101	7.2	\$ 892

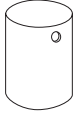
Description

- Veneer Cylinder Base
- Weighted for Stability
- 2 Wire Management Grommets Standard at Top with 8" Opening Standard in Bottom
- Not Available in LG, WH, SG, or TK

Options: Specify & Add

GCB1S	Optional Grommet Top Edge (1)	\$	N/C
NOGC	Optional No Grommets At Top Edges	\$	N/C

METAL BASE	01-0400MBB Black	32	32	27 3/4	-	-	32	3.2	\$ 632
	01-0400MBA Aluminum	32	32	27 3/4	-	-	32	3.2	\$ 632



Open
Market
Only

Description

- Shipped KD - Some Assembly Required
- For use with 42" or 36" Circular Top

METAL BASE	01-0404MBB Black	36	36	27 3/4	-	-	35	3.0	\$ 941
	01-0404MBA Aluminum	36	36	27 3/4	-	-	35	3.0	\$ 941

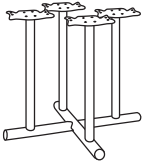
Description

- Shipped KD - Some Assembly Required
- For Use on 48" Round Tables

X BASE	01-2424XB For Use on 42" and 36" Round Tables	24	24	28 1/2	-	-	43	2.7	\$ 612
--------	--	----	----	--------	---	---	----	-----	--------

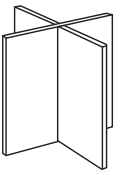
Description

- Laminate X Base
- Shipped KD - Some Assembly Required

NOTE: See Niche 9400 Conference Series to order 94-3030XB for 48" Round Tables.

For ordering options, see back of Resilience Identification card at the beginning of section.

Item	Model No.	W	D	H	K	R	Ship Wt	Cubic Ft	List Price
BOW TOP WORKSURFACE 	38-4272BWT	72	42-36	1 ³ / ₁₆	-	-	125	7.1	\$ 1582
	38-3672BWT	72	36-30	1 ³ / ₁₆	-	-	110	6.2	\$ 1506

Description

- Shaped on Four Sides

DESK WORKSURFACE	38-3672TP	72	36	1 ³ / ₁₆	-	-	115	6.2	\$ 1018
------------------	-----------	----	----	--------------------------------	---	---	-----	-----	---------

Description

- Shaped on Four Sides
- For Table Lift Options, See Accessories

For ordering options, see back of Resilience Identification card at the beginning of section.

For grommet options, see page 290.

Item	Model No.	W	D	H	K	R	Ship Wt	Cubic Ft	List Price
WORKSURFACE 30" DEEP 	38-3084TP	84	30	1 ³ / ₁₆	-	-	95	5.3	\$ 1130
	38-3078TP	78	30	1 ³ / ₁₆	-	-	90	5.0	\$ 1087
	38-3072TP	72	30	1 ³ / ₁₆	-	-	85	4.6	\$ 998
	38-3066TP	66	30	1 ³ / ₁₆	-	-	80	4.2	\$ 960
	38-3060TP	60	30	1 ³ / ₁₆	-	-	75	3.8	\$ 885
	38-3054TP	54	30	1 ³ / ₁₆	-	-	70	3.4	\$ 835
	38-3048TP	48	30	1 ³ / ₁₆	-	-	60	3.1	\$ 739
	38-3042TP	42	30	1 ³ / ₁₆	-	-	55	2.7	\$ 732

Description

- Shaped on Four Sides
- For Use on 30" Deep Pedestals
- When 30" Deep Modular Tops have a Kneespace of 60" or Greater, a Support T Panel is Needed to Support the Top
- For Table Lift Options, See Accessories

For ordering options, see back of Resilience Identification card at the beginning of section.

For grommet options, see page 290.

Item	Model No.	W	D	H	K	R	Ship Wt	Cubic Ft	List Price
WORKSURFACE 24" DEEP 	38-24108TP	108	24	1 ³ / ₁₆	-	-	110	5.5	\$ 1130
	38-24102TP	102	24	1 ³ / ₁₆	-	-	105	5.2	\$ 1005
	38-2496TP	96	24	1 ³ / ₁₆	-	-	100	4.9	\$ 975
	38-2490TP	90	24	1 ³ / ₁₆	-	-	95	4.6	\$ 946
	38-2484TP	84	24	1 ³ / ₁₆	-	-	90	4.3	\$ 907
	38-2478TP	78	24	1 ³ / ₁₆	-	-	85	4.	\$ 857
	38-2472TP	72	24	1 ³ / ₁₆	-	-	80	3.7	\$ 789
	38-2466TP	66	24	1 ³ / ₁₆	-	-	75	3.4	\$ 761
	38-2460TP	60	24	1 ³ / ₁₆	-	-	70	3.1	\$ 664
	38-2454TP	54	24	1 ³ / ₁₆	-	-	65	2.8	\$ 658
	38-2448TP	48	24	1 ³ / ₁₆	-	-	55	2.5	\$ 582
	38-2442TP	42	24	1 ³ / ₁₆	-	-	50	2.2	\$ 538
	38-2436TP	36	24	1 ³ / ₁₆	-	-	45	1.9	\$ 493
	38-2430TP	30	24	1 ³ / ₁₆	-	-	36	1.6	\$ 465
	38-2418TP	18	24	1 ³ / ₁₆	-	-	28	1.0	\$ 391

Description

- Shaped on Four Sides
- For Use on 24" Deep Pedestals/Files
- When 24" Deep Modular Tops have a Kneespace of 60" or Greater, a Support T Panel is Needed to Support the Top
- For Table Lift Options, See Accessories

For ordering options, see back of Resilience Identification card at the beginning of section.

For grommet options, see page 290.

Item	Model No.	W	D	H	K	R	Ship Wt	Cubic Ft	List Price	
EXTENDED CORNER ANGLED TOP	Left Top	Right Top								
	38-3672ETL	38-3672ETR	72	36-24	1 ³ / ₁₆	-	-	95	6.2	\$ 1005
	38-3066ETL	38-3066ETR	66	30-24	1 ³ / ₁₆	-	-	60	4.1	\$ 966

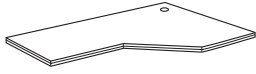
Description

- Extended Corner Top Worksurface
- Grommet in Top
- Shaped on All Sides
- For Table Lift Options, See Accessories

Item	Model No.	W	D	H	K	R	Ship Wt	Cubic Ft	List Price	
EXTENDED CORNER COCKPIT TOP	Left Top	Right Top								
	38-3672ETL1	38-3672ETR1	72	36-24	1 ³ / ₁₆	-	-	95	6.1	\$ 1005
	38-3066ETL1	38-3066ETR1	66	30-24	1 ³ / ₁₆	-	-	60	4.1	\$ 966



Description

- Extended Corner Top Worksurface
- Grommet in Top
- Shaped on All Sides
- For Table Lift Options, See Accessories

For ordering options, see back of Resilience Identification card at the beginning of section.

For grommet options, see page 290.

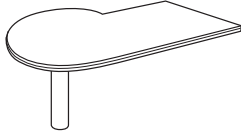
Item	Model No.	W	D	H	K	R	Ship Wt	Cubic Ft	List Price	
P-TOP WITH CYLINDER BASE	Left Top	Right Top								
	38-4272TL	38-4272TR	72	42-36	30	-	-	120	7.1	\$ 1627
	38-3672TL	38-3672TR	72	36-30	30	-	-	115	6.2	\$ 1484

Description

- Metal Cylinder Base - 4 1/2" Diameter. Must Specify: Black or Aluminum.
- Shipped KD

D-TOP WITH CYLINDER BASE	38-3672DR	72	36	30	-	-	115	6.2	\$ 1373
	38-3072DR	72	30	30	-	-	110	4.6	\$ 1278
	38-3066DR	66	30	30	-	-	105	4.2	\$ 1130

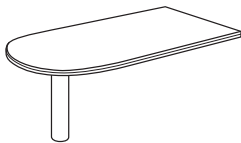
Description

- Metal Cylinder Base - 4 1/2" Diameter. Must Specify: Black or Aluminum.
- Shipped KD

For ordering options, see back of Resilience Identification card at the beginning of section.

For grommet options, see page 290.

Item	Model No.	W	D	H	K	R	Ship Wt	Cubic Ft	List Price
PEDESTAL BOX/BOX/FILE 	38-3618PD1	18	36	28 5/16	-	-	139	13.1	\$ 1241
	38-3018PD1	18	30	28 5/16	-	-	108	12.6	\$ 1228
	38-2418PD1	18	24	28 5/16	-	-	93	9.0	\$ 1071

Description

- Locking
- Box/Box/File
- Finished Back

PEDESTAL FILE/FILE 	38-3618PD2	18	36	28 5/16	-	-	139	13.1	\$ 1241
	38-3018PD2	18	30	28 5/16	-	-	108	12.6	\$ 1228
	38-2418PD2	18	24	28 5/16	-	-	93	9.0	\$ 1071

Description

- Locking
- File/File
- Finished Back

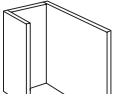
PEDESTAL SHELL 	38-3618PD3	18	36	28 5/16	-	-	45	13.1	\$ 487
	38-3018PD3	18	30	28 5/16	-	-	48	12.6	\$ 434
	38-2418PD3	18	24	28 5/16	-	-	40	9.0	\$ 370

Description

- Used to Complete Single Pedestal Configurations
- Can be Used as Left Pedestal Shell or Right Pedestal Shell
- Finished Back

For ordering options, see back of Resilience Identification card at the beginning of section.

Item	Model No.	W	D	H	K	R	Ship Wt	Cubic Ft	List Price
CREDENZA/RETURN PEDESTAL DOOR BOOKCASE	Hinged Left								
	38-2418PD4L	18	24	28 5/16	-	-	70	9.6	\$ 709

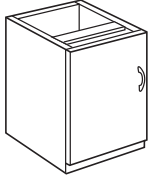
Description

- Adjustable Shelf

LATERAL FILE FILE/FILE	38-2436LF1	36	24	28 5/16	-	-	154	18.5	\$ 1309
---------------------------	------------	----	----	---------	---	---	-----	------	---------

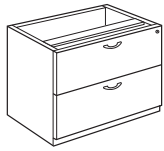
Description

- Locking
- Anti-Tilt System
- Finished Back

LATERAL FILE BOX/BOX/FILE/LATERAL	38-2436LF2	36	24	28 5/16	-	-	181	18.5	\$ 1364
--------------------------------------	------------	----	----	---------	---	---	-----	------	---------

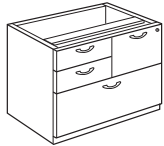
Description

- Locking File Drawers Only
- Finished Back

LATERAL FILE FILE/FILE/LATERAL	38-2436LF4	36	24	28 5/16	-	-	154	18.5	\$ 1364
-----------------------------------	------------	----	----	---------	---	---	-----	------	---------

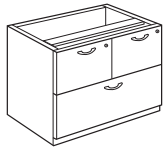
Description

- Locking File Drawers
- Finished Back

For ordering options, see back of Resilience Identification card at the beginning of section.

Item	Model No.	W	D	H	K	R	Ship Wt	Cubic Ft	List Price
DOOR BOOKCASE	38-2436DB	36	24	28 ⁵ / ₁₆	-	-	104	18.0	\$ 885

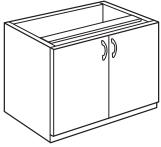
Description

- Adjustable Shelf
- Shelf 12 ¹/₈" Deep
- Finished Back

OPEN BOOKCASE	38-2436BC	36	24	28 ⁵ / ₁₆	-	-	96	18.0	\$ 709
---------------	-----------	----	----	---------------------------------	---	---	----	------	--------

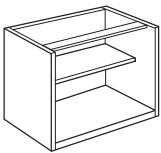
Description

- Adjustable Shelf
- Shelf 12 ¹/₈" Deep
- Finished Back

FOUR DRAWER FILE	38-2436QF	36	24	53 ⁵ / ₁₆	-	-	205	31.6	\$ 2326
------------------	-----------	----	----	---------------------------------	---	---	-----	------	---------

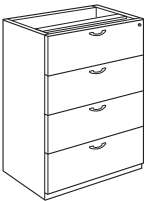
Description

- Four File Drawers
- Locking
- Anti-Tilt System
- Finished Back

THREE DRAWER FILE	38-2436TF	36	24	40 ¹³ / ₁₆	-	-	180	25.9	\$ 2053
-------------------	-----------	----	----	----------------------------------	---	---	-----	------	---------

Description

- Three File Drawers
- Locking
- Anti-Tilt System
- Finished Back

For ordering options, see back of Resilience Identification card at the beginning of section.

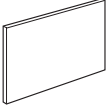
Item	Model No.	W	D	H	K	R	Ship Wt	Cubic Ft	List Price
MODESTY PANEL 	38-5428BP	54	3/4	28 5/16	-	-	65	3.7	\$ 377
	38-4828BP	48	3/4	28 5/16	-	-	55	3.3	\$ 362
	38-4228BP	42	3/4	28 5/16	-	-	50	2.9	\$ 348
	38-3628BP	36	3/4	28 5/16	-	-	45	2.6	\$ 324
	38-3028BP	30	3/4	28 5/16	-	-	30	2.1	\$ 310
	38-2428BP	24	3/4	28 5/16	-	-	18	1.7	\$ 282
	38-1828BP	18	3/4	28 5/16	-	-	12	1.4	\$ 245

Description

- Shipped with Attachment Hardware
- Modesty Panels are Used in Conjunction with Component Worksurfaces and Component Pedestals and Files to Create a Fully Enclosed Kneespace in Desk, Bridge, Return, or Credenza Applications

Options: Specify & Add

1-GRMT	Optional Top-Center Grommet	\$	48
--------	-----------------------------	----	----

For ordering options, see back of Resilience Identification card at the beginning of section.

Item	Model No.	W	D	H	K	R	Ship Wt	Cubic Ft	List Price
SUPPORT T	38-1010SP	10	10	28 5/16	-	-	13	.9	\$ 216

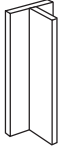
Description

- Support "T" is Required for Added Support When Open Kneespace Area is 60" or Greater Under Worksurfaces
- Finished on All Sides

GANGING BRACKET	38-0104GB	4	1 1/2	1 1/4	-	-	1	-	\$ 36
-----------------	-----------	---	-------	-------	---	---	---	---	-------

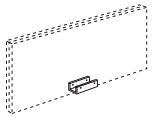
Description

- Attaches Pedestals and Files without Defacing Visible Areas of Units Allowing for Future Reconfigurability
- Optional Ganging Brackets can be Used to Attach Two or More Pedestals or Files in Side by Side Configuration

For ordering options, see back of Resilience Identification card at the beginning of section.

Item	Model No.	W	D	H	K	R	Ship Wt	Cubic Ft	List Price
EXECUTIVE "L"	38-1	72	84	30	-	-	420	75.9	\$ 3956

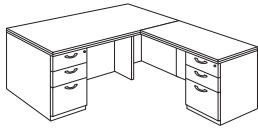

Consists of:	Qty		
38-3672LP1	1	• Left Pedestal Desk	\$ 2311
38-2448RF1	1	• Executive Right Return	\$ 1645

EXECUTIVE "U" P-TOP	38-3	72	114	30	-	-	491	97.4	\$ 4684
------------------------	------	----	-----	----	---	---	-----	------	---------

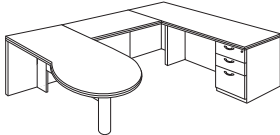

Consists of:	Qty		
38-4272PL	1	• P-Top with End Support Cylinder Base and Modesty Panel	\$ 1871
38-2448UF	1	• Executive Bridge Unit	\$ 849
38-2472RC1	1	• Right Pedestal Credenza	\$ 1964

All pedestal desks shown as left.
 All returns shown as right.

For ordering options, see back of Resilience Identification card at the beginning of section.
 For grommet options, see page 290.

Item	Model No.	W	D	H	K	R	Ship Wt	Cubic Ft	List Price
EXECUTIVE WORKSTATION	38-7	72	114	72	-	-	930	124.1	\$ 8039

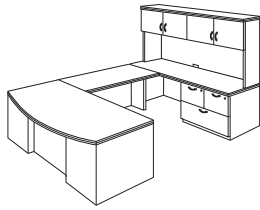
Consists of:
Qty

38-4272LP1	1	• Bow Top Left Pedestal Desk	\$ 2658
38-2448UF	1	• Bridge Unit	\$ 849
38-2472TP	1	• Component Top	\$ 789
38-2436LF4	1	• Component Lateral File	\$ 1364
38-2418PD3	1	• Pedestal Shell	\$ 370
38-1828BP	1	• Modesty Panel	\$ 245
38-1472HD	1	• Door Hutch	\$ 1764

EXECUTIVE OFFICE	38-8	72	114	72	-	-	1215	142.1	\$ 10902
------------------	------	----	-----	----	---	---	------	-------	----------

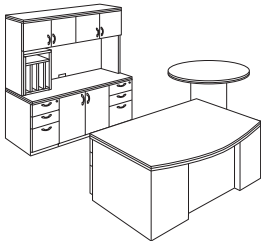

Consists of:
Qty

38-4272DP4	1	• Double Pedestal/Bow Front Desk	\$ 3146
38-2472SC4	1	• Storage Credenza	\$ 3352
38-1472HD	1	• Door Hutch	\$ 1764
38-1418HV	1	• Portable Tower Unit	\$ 533
38-4848CT	1	• Circular Table Top	\$ 1130
38-2020CB	1	• Cylinder Base	\$ 977

For ordering options, see back of Resilience Identification card at the beginning of section.

For grommet options, see page 290.

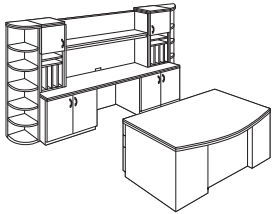
Item	Model No.	W	D	H	K	R	Ship Wt	Cubic Ft	List Price
EXECUTIVE OFFICE	38-9	144	114	72	-	-	1215	166.0	\$ 11039



Consists of:	Qty		
38-4272DP1	1	• Double Pedestal/Bow Front Desk	\$ 3146
38-2436DB	2	• Component Door Bookcase	\$ 1770
38-24108TP	1	• Component Top	\$ 1130
38-1418HL2	1	• Tower Unit	\$ 900
38-1418HR2	1	• Tower Unit	\$ 900
38-1472HN	1	• Open Hutch	\$ 695
38-1472QR	2	• Quarter Round Bookcase	\$ 2174
38-3628BP	1	• Back Panel	\$ 324

EXECUTIVE "U" WORKSTATION	38-11	108	114	72	-	-	1183	188.6	\$ 10885
---------------------------	-------	-----	-----	----	---	---	------	-------	----------

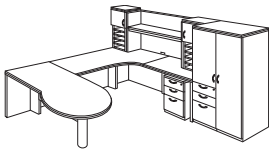

Consists of:	Qty		
38-4272PL	1	• Left P Unit with End Panel Cylinder Base and Modesty Panel	\$ 1871
38-3672ETL1	1	• Extended Corner Cockpit Top	\$ 1005
38-3618PD3	1	• Pedestal Shell	\$ 487
38-5428BP	1	• Back Panel	\$ 377
38-2436TP	1	• Component Top	\$ 493
38-2418PD3	1	• Pedestal Shell	\$ 370
38-1828BP	1	• Modesty Panel	\$ 245
38-1418HL1	1	• Storage Tower	\$ 873
38-1436HN	1	• Open Hutch	\$ 501
38-1418HR1	1	• Storage Tower	\$ 873
38-3672WC1	1	• Wardrobe/Storage Cabinet	\$ 2653
38-1824MP	1	• Mobile Pedestal	\$ 1137

For ordering options, see back of Resilience Identification card at the beginning of section.

For grommet options, see page 290.

Item	Model No.	W	D	H	K	R	Ship Wt	Cubic Ft	List Price
EXECUTIVE "L" COCKPIT SHELL BOW TOP	38-13	78	84	30	-	-	470	83.0	\$ 4034

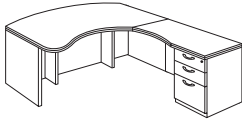

Consists of:	Qty		
38-4278CLSH	1	• Executive Left Cockpit Shell	\$ 2298
38-2442CRF1	1	• Cockpit Right Return	\$ 1736

NOTE: Tops are non-reconfigurable.

EXECUTIVE "U" COCKPIT SHELL	38-17	78	98	30	-	-	665	111.0	\$ 5876
-----------------------------	-------	----	----	----	---	---	-----	-------	---------

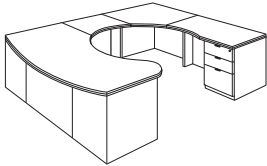

Consists of:	Qty		
38-4278CLSH	1	• Executive Left Cockpit Shell	\$ 2298
38-2420CUF	1	• Cockpit Bridge	\$ 664
38-3636CCU	1	• Cockpit Corner Unit	\$ 1178
38-2442CRF1	1	• Cockpit Right Return	\$ 1736

NOTE: Tops are non-reconfigurable.

For ordering options, see back of Resilience Identification card at the beginning of section.

HOW PEDESTALS AND FILES ARE ATTACHED TO TOPS

Pedestals and files are attached to tops by metal to metal fasteners. This is for the future reconfigurability of units. The diagram shows how tops are fastened with metal inserts into each top. Metal inserts are placed in all possible locations of the top for any pedestal or file configuration. Post and Cam systems are also used for the attachment of tops to pedestals and files.

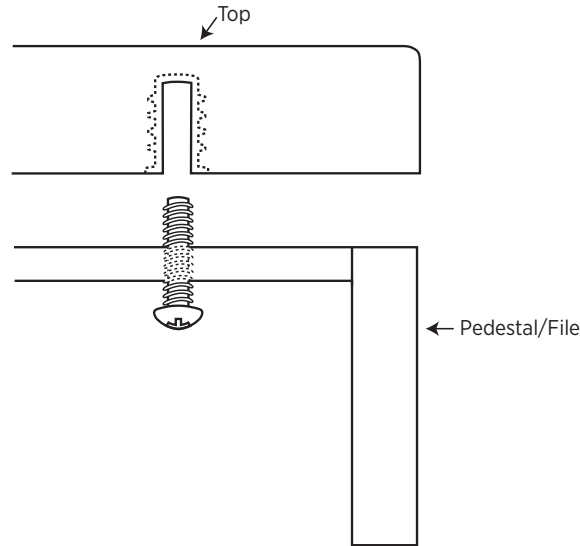

HOW DESK MODESTY PANELS ARE ATTACHED TO PEDESTALS

Desk modesty panels are attached to pedestals by metal brackets. The diagram shows the bracket connecting the modesty panel to the inside of the pedestal in the kneespace. When ordering assembled units, these brackets are already used to assemble the unit. When specifying component modesty panels, two brackets will ship with each modesty panel for field assembly.

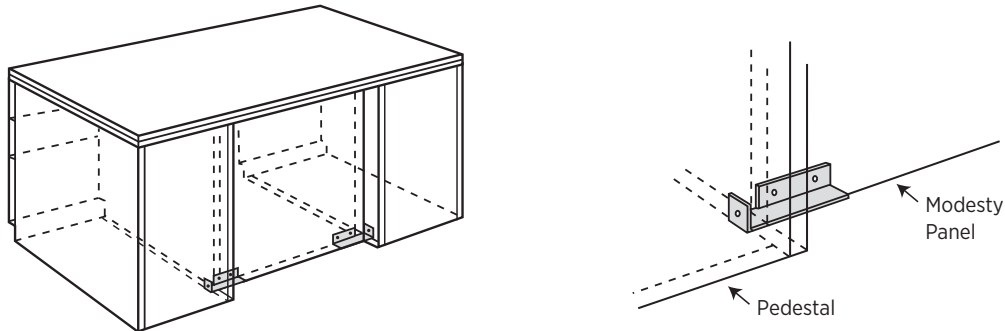

HOW CREDENZA/RETURN MODESTY PANELS ARE ATTACHED

Credenza/Return modesty panels are attached to pedestals and files by metal brackets. The diagram shows the bracket connecting the modesty panel to the inside of the pedestal or file in the kneespace. When ordering assembled units, these brackets are already used to assemble the unit. When specifying component modesty panels, two brackets will ship with each modesty panel for field assembly.

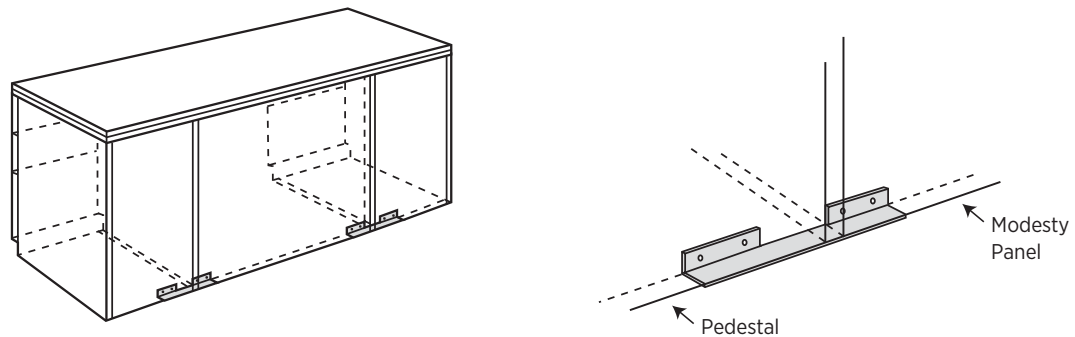

TACKBOARD: SURFACE MOUNTED HUTCHES – 23 7/8" TALL

Size	Model #	COM ydg	COM, Grade 1, 2 or 3 List Price	Grade 4 List Price	Grade 5 List Price	Grade 6 List Price	Grade 7 List Price	Grade 8 List Price	Grade 9 List Price	Grade 10 List Price
36"	TB-3836H	1.25	\$ 242	\$ 355	\$ 406	\$ 463	\$ 538	\$ 617	\$ 713	\$ 821
66"	TB-3866H	2.0	\$ 336	\$ 518	\$ 600	\$ 690	\$ 810	\$ 937	\$ 1090	\$ 1263
72"	TB-3872H	2.25	\$ 357	\$ 561	\$ 653	\$ 755	\$ 890	\$ 1033	\$ 1204	\$ 1399

TACKBOARD: WALL MOUNTED HUTCHES – 21 7/8" TALL

Size	Model #	COM ydg	COM, Grade 1, 2 or 3 List Price	Grade 4 List Price	Grade 5 List Price	Grade 6 List Price	Grade 7 List Price	Grade 8 List Price	Grade 9 List Price	Grade 10 List Price
36"	TB-0136W	1.25	\$ 274	\$ 387	\$ 438	\$ 495	\$ 570	\$ 649	\$ 744	\$ 853

TACKBOARD: CORNER UNIT HUTCHES – 17 3/4" TALL

Size	Model #	COM ydg	COM, Grade 1, 2 or 3 List Price	Grade 4 List Price	Grade 5 List Price	Grade 6 List Price	Grade 7 List Price	Grade 8 List Price	Grade 9 List Price	Grade 10 List Price
36"	TB-3836CH	2.5	\$ 398	\$ 625	\$ 728	\$ 841	\$ 990	\$ 1149	\$ 1340	\$ 1556
42"	TB-3842CH	2.5	\$ 407	\$ 634	\$ 737	\$ 850	\$ 999	\$ 1159	\$ 1349	\$ 1565

TASKLIGHTS – Includes 3 Wire Management Grommets

Model #	Size	Description	List Price
TL-0824	22 1/2" x 1 5/8" x 7/8"	84-LED, 7 Watts	\$ 234
TL-0848	47 1/2" x 1 5/8" x 7/8"	240-LED, 18 Watts	\$ 280

Revolutions™

Casegoods Collection

How to Order

MODEL NO.	DESCRIPTION
42-4272DP1	Finish AC
	Edge X
	Pull MBB

All options must be labeled and specified.



Specifications



veneer

Veneers on exposed surfaces are select grade sliced Cherry, Maple, and American Black Walnut and are carefully selected and matched to assure proper balance and consistency.

tops

Wood veneer tops are 5-ply balanced construction, 1 3/8" thick with solid hardwood rims. Tops are mitered on all four corners. Tops are shaped on all four sides for complete design appeal. Tops are available in four different edge designs. Grain direction runs left to right unless otherwise noted.

chassis construction

Built to be reconfigurable, tops, end panels, and modesty panels are assembled using European-style mechanical fasteners and heavy-duty, 16-gauge joining brackets. Veneered parting rails assure a sturdy pedestal. All units are equipped with heavy-duty, adjustable glides to ensure proper leveling and compensate for uneven floors.

drawers

All drawer fronts are standard with elegant Walnut, Cherry or Maple veneer faces. Fronts are 3-ply construction and 3/4" thick with vertically matched grain. Drawer sides and backs are constructed with 7/16" thick hardwood sides and 5/32" hardboard bottoms. Drawers feature 5-sided construction allowing for easy removal of drawer fronts. Drawer interiors are sanded, sealed, and finished to provide for a smooth, quality feel and appearance.

drawer suspension

File drawers and box drawers feature high quality, black progressive full extension slides with precision steel ball bearings to ensure a smooth, quiet operation. All suspensions have a lifetime warranty.

filing hardware

All file drawers are standard with custom fitted filing systems designed to accommodate a variety of filing requirements. Desk file drawers provide legal filing or two rows of letter filing side to side. Credenza/Return file drawers provide legal or letter filing side to side.

locking

All pedestals and files feature locking. Removable lock cylinders allow for units to be re-keyed at a later date if required. Units are shipped randomly keyed as standard. Lock cores match pull color.

cord management

Route power and data cables away from the worksurface through inherent grommet placement. Optional black grommets are standard in back panels of assembled returns, bridge units, kneespace credenzas, and hutch units. A grommet is standard in tops of corner units. Grommets may be ordered in the tops of desks, returns, bridge units, credenzas, and component work-surfaces. See page 336 for all optional grommet locations.

Undersurface tracks are available for additional cord management. Silver grommets are also available. See Accessories.

finish

Revolutions features Ultra-Violet matte finish on all exposed surfaces by utilizing roll-coat UV technology. Our durable UVAdvantage® finish makes surfaces less likely to be damaged by abrasions, scratches, water, alcohol, stains, and common chemicals. Our UVAdvantage® finish magnifies the beauty of our wood finishes and reduces the darkening, aging, and yellowing process of wood furniture that naturally occurs over time. Once cured by UV lighting, our UVAdvantage® finish does not emit irritable toxins, formaldehyde, or solvents into the air creating a safe work environment within new furniture installations. This process has allowed us to achieve third party certification for Indoor Air Quality. Additionally our UVAdvantage® finish greatly reduces hazardous air pollutants which contribute to smog formation, and our UVAdvantage® finish is recaptured over and over again reducing waste materials. Automated production technology eliminates exposure to sprayed chemicals in our factories. High gloss UVAdvantage® finish available on request.

Modular Reconfigurability

Finish Options



Clear Maple
CM



Light Maple
LM



Golden Cherry
GC



Bourbon Cherry
BC



Autumn Cherry
AC



Dark Cherry
DC



Espresso Walnut
EW



Harvest Walnut
HW

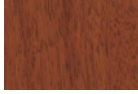

Legacy Walnut
LW



Mahogany on Walnut
MW



Presidential Walnut
PW



Columbian Walnut
CO

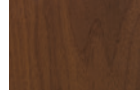

Artisan Walnut
AW

Edge Options



Tail
Z



Tri-Round
E



Flute
X



Square
Y

Pull Options



Aluminum Arc
AAC



Aluminum Bar
ABR



Satin Nickel Bullet
SNB



Satin Nickel Curved
SNC



Aluminum Orbit
AOR



Black Arc
BAC



Black Bar
BBR



Matte Black Bullet
MBB



Matte Black Curved
MBC



Black Orbit
BOR

COORDINATING PRODUCTS

Revolutions Casegoods offers options to coordinate with Aura Conference and Aura Reception.

INTERIOR DRAWER DIMENSIONS

REVOLUTIONS 4200 INTERIOR DRAWER DIMENSIONS

Item	Drawers	W	L	D
42-4272DP	Box	14 ¹⁷ / ₃₂	25 ¹ / ₄	3 ²¹ / ₃₂
42-3672DP	File	14 ¹⁷ / ₃₂	25 ¹ / ₄	8 ²⁹ / ₃₂
42-4272LP				
42-4272RP				
42-3672LP				
42-3672RP				
42-3066DP				
42-3066LP				
42-3066RP				
42-3060DP				
42-3018PD				
42-3618PD				
42-2448LF	Box	14 ¹⁷ / ₃₂	19 ¹ / ₄	3 ²¹ / ₃₂
42-2448RF	File	14 ¹⁷ / ₃₂	19 ¹ / ₄	8 ²⁹ / ₃₂
42-4278CLP				
42-4278CRP				
42-2442CLF				
42-2442CRF				
42-2472SC				
42-2472KC				
42-2466KC				
42-2472LC				
42-2472RC				
42-2466LC				
42-2466RC				
42-1824MP				
42-2418PD				
42-2436L2	File	32 ⁹ / ₁₆	19 ¹ / ₄	8 ²⁹ / ₃₂
42-2436L3				
42-2436L4				
42-2436LF1				
42-2436LF6				
42-2436TF				
42-2436QF				
42-3672VC2				
42-3672SU2				
42-2418OF	File	14 ⁷ / ₈	19 ¹ / ₄	8 ²⁹ / ₃₂
42-1824MP2	Top File	14 ¹⁷ / ₃₂	16 ³ / ₈	8 ²⁹ / ₃₂
	Btm File	14 ¹⁷ / ₃₂	19 ¹ / ₄	8 ²⁹ / ₃₂
42-3672VC	Box	32 ⁹ / ₁₆	19 ¹ / ₄	3 ²¹ / ₃₂
42-3672SU1	File	32 ⁹ / ₁₆	19 ¹ / ₄	8 ²⁹ / ₃₂
42-2436LF2	Box	14 ¹⁷ / ₃₂	19 ¹ / ₄	3 ²¹ / ₃₂
	File	14 ¹⁷ / ₃₂	19 ¹ / ₄	8 ²⁹ / ₃₂
	File	32 ⁹ / ₁₆	19 ¹ / ₄	8 ²⁹ / ₃₂
42-2436LF4	File	14 ⁷ / ₈	19 ¹ / ₄	8 ²⁹ / ₃₂
	File	32 ⁹ / ₁₆	19 ¹ / ₄	8 ²⁹ / ₃₂
42-2122CD	Center	19 ⁵ / ₈	19 ¹ / ₈	1 ²⁹ / ₃₂
42-1622CD	Center	19 ⁵ / ₈	15 ¹ / ₈	1 ²⁹ / ₃₂

FILING CAPABILITIES

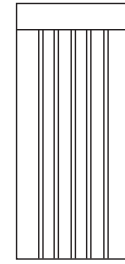
 14 ¹⁷/₃₂ x 19 ¹/₄

Legal Side to Side

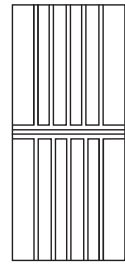

Letter Side to Side

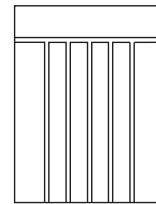
 14 ¹⁷/₃₂ x 25 ¹/₄

Legal Side to Side

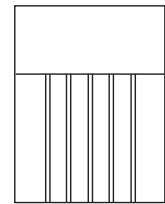

Letter Side to Side

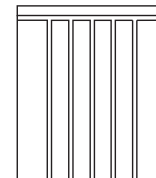
 14 ⁷/₈ x 16 ³/₈

Legal Side to Side

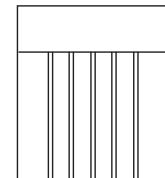

Letter Side to Side

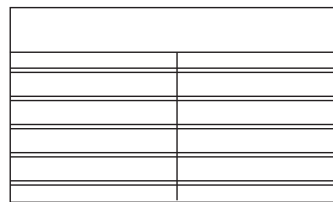
 32 ⁹/₁₆ x 19 ¹/₄

2 Rows Letter or Legal Front to Back

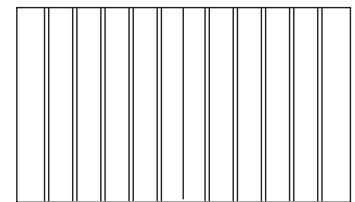

1 Row Letter or Legal Side to Side

GROMMET LOCATIONS

Grommets are standard in the back panels of returns, bridges, and credenzas. These units may be ordered without grommets at no additional charge. Please specify "NO GROMMET" on order.

Grommets are available on hutches in standard locations for tasklight management at no additional charge. Please specify HUGRMT.

Desk grommets are available in standard locations. Please specify and add an upcharge of \$48 list for each grommet.

Specify grommet locations.

- GL - Grommet Left
- GC - Grommet Center
- GR - Grommet Right

Example: 42-3672DP2-GL-GR (Grommet Left, Grommet Right)

Standard grommet options are available on cockpit units. Contact Customer Service for more information.

Grommets may be ordered in non-standard locations. Please call Customer Service to assist with how to order and additional lead time requirements.

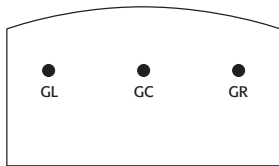

42-4272DP
 42-4272LP
 42-4272RP
 42-4272BWT
 42-3672BWT

GL/GR - 6" from ends, 27 1/4" from user side.
 GC - 27 1/4" from user side.

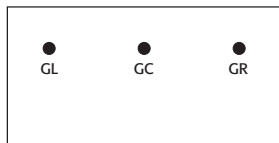

42-3672DP
 42-3672LP
 42-3672RP
 42-3672TP

GL/GR - 6" from ends, 27 1/4" from user side.
 GC - 27 1/4" from user side.

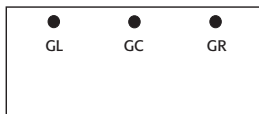

42-3066DP
 42-3066LP
 42-3066RP
 42-3042TP
 42-3048TP
 42-3054TP
 42-3060TP
 42-3066TP
 42-3072TP
 42-3078TP
 42-3084TP

GL/GR - 6" from ends, 21 1/4" from user side.
 GC - 21 1/4" from user side.

GROMMET LOCATIONS - CONTINUED

42-2436RTP
 42-2442RTP
 42-2448RTP
 42-2454RTP
 42-2460RTP
 42-2466RTP
 42-2472RTP
 42-2430TP
 42-2436TP
 42-2442TP
 42-2448TP
 42-2454TP
 42-2460TP
 42-2466TP
 42-2472TP
 42-2478TP
 42-2484TP
 42-2490TP
 42-2496TP

42-24102TP
 42-24108TP
 42-2448LF
 42-2448RF
 42-2448UF
 42-2442UF
 42-2436UF
 42-2436UFH
 42-2442UFH
 42-2448UFH
 42-2472LC
 42-2472RC
 42-2466LC
 42-2466RC
 42-2472KC
 42-2466KC

GL/GR - 6" from ends, 21 1/4" from user side.
 GC - 21 1/4" from user side.

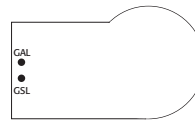

42-4272PR
 42-3672PR
 42-4272TR
 42-3672TR



42-4272PL
 42-3672PL
 42-4272TL
 42-3672TL

GAL/GSL - 12" from approach or seated side, 6" from end.
 GSR/GAR - 12" from approach or seated side, 6" from end.



42-3672DUR
 42-3072DUR
 42-3060DUR



42-3672DUL
 42-3672DR
 42-3072DUL
 42-3072DR
 42-3060DUL
 42-3060DR

GAL/GSL - 12" from approach or seated side, 6" from end.
 GAR/GSR - 12" from approach or seated side, 6" from end.

LOCKING HUTCH AND TOWER DOORS

Locking doors are available on hutches and towers. Please specify with locking and add \$71 list to the following units.

42-1472HD 42-1472AH
 42-1466HD 42-1466AH

Please specify with locking and add \$58 list to the following units.

42-1436HD 42-1436AH
 42-1436WD 42-1436AW

Please specify with locking and add \$43 list to the following units.

42-1418HL1 42-1418HL2
 42-1418HR1 42-1418HR2
 42-1418AHL1 42-1418AHL2
 42-1418AHR1 42-1418AHR2

Item	Model No.	W	D	H	K	R	Ship Wt	Cubic Ft	List Price
EXECUTIVE DOUBLE PED DESK BOW TOP	42-4272DP1	72	42-36	30	36	-	352	58.4	\$ 5432

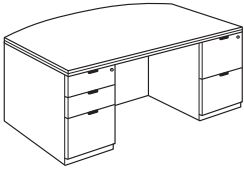
Description

- Bow Top
- Stepped Front
- Locking Pedestals
- Legal Width Pedestals
- Box/Box/File in Left Pedestal
- File/File in Right Pedestal

EXECUTIVE DOUBLE PED DESK BOW TOP	42-4272DP2	72	42-36	30	36	-	352	58.4	\$ 5432
--------------------------------------	------------	----	-------	----	----	---	-----	------	---------

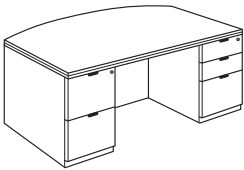

Description

- Bow Top
- Stepped Front
- Locking Pedestals
- Legal Width Pedestals
- File/File in Left Pedestal
- Box/Box/File in Right Pedestal

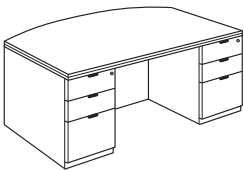
EXECUTIVE DOUBLE PED DESK BOW TOP	42-4272DP4	72	42-36	30	36	-	352	58.4	\$ 5432
--------------------------------------	------------	----	-------	----	----	---	-----	------	---------

Description

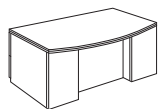
- Bow Top
- Stepped Front
- Locking Pedestals
- Legal Width Pedestals
- Box/Box/File in Pedestals



Approach View

For ordering options, see back of Revolutions Identification card at the beginning of section.

For grommet options, see page 336.

For center drawer options, see page 359.

Item	Model No.	W	D	H	K	R	Ship Wt	Cubic Ft	List Price
EXECUTIVE DOUBLE PED DESK RECTANGULAR TOP	42-3672DP1	72	36	30	36	-	335	51.7	\$ 4563
	42-3066DP1	66	30	30	30	-	290	38.7	\$ 4234

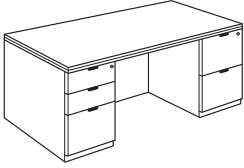
Description

- Stepped Front
- Locking Pedestals
- Legal Width Pedestals
- Box/Box/File in Left Pedestal
- File/File in Right Pedestal

EXECUTIVE DOUBLE PED DESK RECTANGULAR TOP	42-3672DP2	72	36	30	36	-	335	51.7	\$ 4563
	42-3066DP2	66	30	30	30	-	290	38.7	\$ 4234

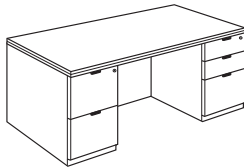

Description

- Stepped Front
- Locking Pedestals
- Legal Width Pedestals
- File/File in Left Pedestal
- Box/Box/File in Right Pedestal

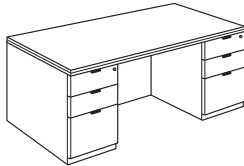
EXECUTIVE DOUBLE PED DESK RECTANGULAR TOP	42-3672DP4	72	36	30	36	-	335	51.7	\$ 4563
	42-3066DP4	66	30	30	30	-	290	38.7	\$ 4234

Description

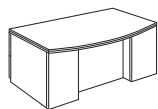
- Stepped Front
- Locking Pedestals
- Legal Width Pedestals
- Box/Box/File in Pedestals



Approach View

For ordering options, see back of Revolutions Identification card at the beginning of section.

For grommet options, see page 336.

For center drawer options, see page 359.

Item	Model No.	W	D	H	K	R	Ship Wt	Cubic Ft	List Price	
EXECUTIVE SINGLE PED DESK BOW TOP	Left Ped	Right Ped								
	42-4272LP1	42-4272RP1	72	42-36	30	30	-	269	58.4	\$ 4885

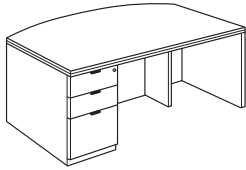
Description

- Bow Top
- Stepped Front
- Locking Pedestal
- Legal Width Pedestal
- Box/Box/File in Pedestal

EXECUTIVE SINGLE PED DESK RECTANGULAR TOP	Left Ped	Right Ped								
	42-3672LP1	42-3672RP1	72	36	30	30	-	270	51.7	\$ 3852
	42-3066LP1	42-3066RP1	66	30	30	24	-	242	38.7	\$ 3597

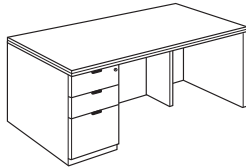
Description

- Stepped Front
- Locking Pedestal
- Legal Width Pedestal
- Box/Box/File in Pedestal

COCKPIT DESK BOW TOP	Left Ped	Right Ped								
	42-4278CLP1	42-4278CRP1	78	42-36	30	36	-	263	66.7	\$ 5259

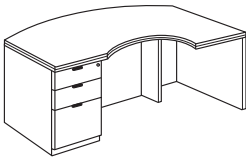
Description

- Bow Top
- Flush Front
- Locking Pedestal
- Legal Width Pedestal
- Box/Box/File in Pedestal

NOTE: Tops are non reconfigurable.

COCKPIT SHELL DESK BOW TOP	Left Ped	Right Ped								
	42-4278CLSH	42-4278CRSH	78	42-36	30	54	-	260	66.7	\$ 3919

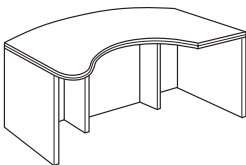
Description

- Bow Top
- Flush Front
- Desk Shell

NOTE: Tops are non reconfigurable.

All pedestal desks shown as left.

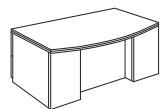

Stepped Front
Approach View

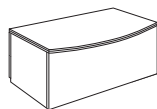

Flush Front
Approach View

For ordering options, see back of Revolutions Identification card at the beginning of section.

For grommet options, see page 336.

For center drawer options, see page 359.

Item	Model No.	W	D	H	K	R	Ship Wt	Cubic Ft	List Price
------	-----------	---	---	---	---	---	---------	----------	------------

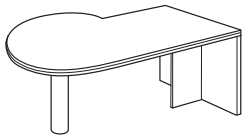
P-TOP PENINSULA DESK

Left Ped	Right Ped	W	D	H	K	R	Ship Wt	Cubic Ft	List Price
42-4272PL	42-4272PR	72	42-36	30	-	-	173	58.0	\$ 3669
42-3672PL	42-3672PR	72	36-30	30	-	-	170	50.0	\$ 3490

Description

- End Panel Support
- Metal Cylinder Base - 4 1/2" Diameter. Must Specify: Black or Aluminum.
- Not Recommended for Freestanding Use

Options: Specify & Add

42-HMD	Optional Half Modesty Panel	\$	203
42-FMD	Optional Full Modesty Panel	\$	338

NOTE: 42-4272PL/PR - For center drawer option with a modesty panel option use 42-1622CD on page 359.
 NOTE: 42-3672PL/PR - Center drawer and keyboard options are not applicable with modesty panel option.

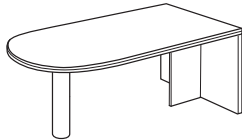
D-TOP PENINSULA DESK

Left Top	Right Top	W	D	H	K	R	Ship Wt	Cubic Ft	List Price
42-3672DUL	42-3672DUR	72	36	30	-	-	170	50.0	\$ 3081
42-3072DUL	42-3072DUR	72	30	30	-	-	165	42.1	\$ 2913
42-3060DUL	42-3060DUR	60	30	30	-	-	135	35.3	\$ 2588

Description

- End Panel Support
- Metal Cylinder Base - 4 1/2" Diameter. Must Specify: Black or Aluminum.
- Not Recommended for Freestanding Use

Options: Specify & Add

		72"	60"
42-HMD	Optional Half Modesty Panel	\$ 203	\$ 169
42-FMD	Optional Half Modesty Panel	\$ 338	\$ 304

NOTE: 42-3672DUL/42-3672DUR - For center drawer option with a modesty panel option use 42-1622CD on page 359.
 NOTE: 42-3072DUL/42-3072DUR/42-3060DUL/42-3060DUR - Center drawer and keyboard options are not applicable with modesty panel option.

For ordering options, see back of Revolutions Identification card at the beginning of section.

For grommet options, see page 336.

Item	Model No.	W	D	H	K	R	Ship Wt	Cubic Ft	List Price	
EXECUTIVE RETURN FILE/FILE	Left Ped									
	Right Ped									
	42-2448LF2	42-2448RF2	48	24	30	30	-	210	23.1	\$ 2839

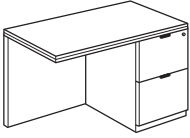
Description

- Locking Pedestal
- Legal Width Pedestal
- File/File in Pedestal
- Grommet in Back Panel
- Grain Direction Runs Front to Back on Worksurface

EXECUTIVE RETURN BOX/BOX/FILE	Left Ped									
	Right Ped									
	42-2448LF1	42-2448RF1	48	24	30	30	-	210	23.1	\$ 2839

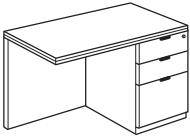
Description

- Locking Pedestal
- Legal Width Pedestal
- Box/Box/File in Pedestal
- Grommet in Back Panel
- Grain Direction Runs Front to Back on Worksurface

COCKPIT RETURN FILE/FILE	Left Ped									
	Right Ped									
	42-2442CLF2	42-2442CRF2	42	24	30	24	-	210	20.4	\$ 2958

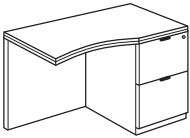
Description

- Locking Pedestal
- Legal Width Pedestal
- File/File in Pedestal
- Grommet in Back Panel
- Grain Direction Runs Front to Back on Worksurface

NOTE: Tops are non reconfigurable.

COCKPIT RETURN BOX/BOX/FILE	Left Ped									
	Right Ped									
	42-2442CLF1	42-2442CRF1	42	24	30	24	-	210	20.4	\$ 2958

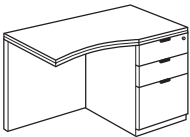
Description

- Locking Pedestal
- Legal Width Pedestal
- Box/Box/File in Pedestal
- Grommet in Back Panel
- Grain Direction Runs Front to Back on Worksurface

NOTE: Tops are non reconfigurable.

All returns shown as right.

For ordering options, see back of Revolutions Identification card at the beginning of section.

For grommet options, see page 336.

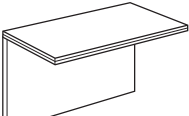
Item	Model No.	W	D	H	K	R	Ship Wt	Cubic Ft	List Price
EXECUTIVE BRIDGE FULL MODESTY 	42-2448UF	48	24	30	48	-	78	5.3	\$ 1587
	42-2442UF	42	24	30	42	-	74	4.6	\$ 1535
	42-2436UF	36	24	30	36	-	68	4.0	\$ 1483

Description

- Grommet in Back Panel
- Grain Direction Runs Front to Back on Worksurface
- Hinged Modesty Panel

NOTE: Keyboards can not be factory installed.

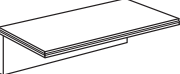
EXECUTIVE BRIDGE HALF MODESTY 	42-2448UFH	48	24	11	48	-	58	5.3	\$ 1170
	42-2442UFH	42	24	11	42	-	54	4.6	\$ 1139
	42-2436UFH	36	24	11	36	-	48	4.0	\$ 1079

Description

- Grain Direction Runs Front to Back on Worksurface
- Hinged Modesty Panel

NOTE: Keyboards can not be factory installed.

COCKPIT BRIDGE 	42-2420CUF	20	24	30	20	-	60	2.3	\$ 1380
---	------------	----	----	----	----	---	----	-----	---------

Description

- Grommet in Back Panel
- Grain Direction Runs Front to Back on Worksurface
- Hinged Modesty Panel

NOTE: Kneespace options are not applicable.

COCKPIT BRIDGE HALF MODESTY 	42-2420CUFH	20	24	11	20	-	42	2.3	\$ 1046
---	-------------	----	----	----	----	---	----	-----	---------

Description

- Grain Direction Runs Front to Back on Worksurface
- Hinged Modesty Panel

NOTE: Kneespace options are not applicable.

For ordering options, see back of Revolutions Identification card at the beginning of section.

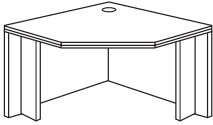
Item	Model No.	W	D	H	K	R	Ship Wt	Cubic Ft	List Price
CORNER UNIT 	42-4242CU Connects to 24" Deep Worksurfaces	42	42	30	25 1/2	-	145	34.5	\$ 2855
	42-3636CU Connects to 24" Deep Worksurfaces	36	36	30	17	-	135	25.7	\$ 2703
	42-424230CU Connects to 30" Deep Worksurfaces	42	42	30	17	-	145	34.5	\$ 3081

Description

- Freestanding Support Unit
- Grommet in Top
- Grain Direction Runs Front to Back on Worksurface

NOTE: Not all keyboards will fit the 42-3636CU and 42-424230CU. Recommended keyboards are 1-KCWR, 1-KCPR, and 1-KC.

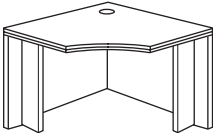
COCKPIT CORNER UNIT 	42-3636CCU Connects to 24" Deep Worksurfaces	36	36	30	17	-	135	25.7	\$ 2826
---	---	----	----	----	----	---	-----	------	---------

Description

- Freestanding Support Unit
- Grommet in Top
- Grain Direction Runs Front to Back on Worksurface

NOTE: Not all keyboards will fit this unit. Recommended keyboards are 1-KCWR, 1-KCPR, and 1-KC.

For ordering options, see back of Revolutions Identification card at the beginning of section.

For grommet options, see page 336.

Item	Model No.	W	D	H	K	R	Ship Wt	Cubic Ft	List Price	
EXECUTIVE CREDENZA FILE/FILE	Left Ped	Right Ped								
	42-2472LC2	42-2472RC2	72	24	30	30	-	203	34.5	\$ 3462
	42-2466LC2	42-2466RC2	66	24	30	24	-	186	31.5	\$ 3244

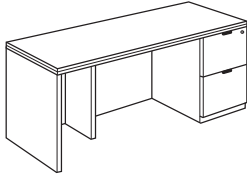
Description

- Locking Pedestal
- Legal Width Pedestal
- File/File in Pedestal
- Grommet in Back Panel

Item	Model No.	W	D	H	K	R	Ship Wt	Cubic Ft	List Price	
EXECUTIVE CREDENZA BOX/BOX/FILE	Left Ped	Right Ped								
	42-2472LC1	42-2472RC1	72	24	30	30	-	203	34.5	\$ 3462
	42-2466LC1	42-2466RC1	66	24	30	24	-	186	31.5	\$ 3244

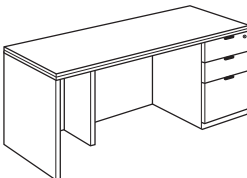
Description

- Locking Pedestal
- Legal Width Pedestal
- Box/Box/File in Pedestal
- Grommet in Back Panel

All credenzas shown as right.

For ordering options, see back of Revolutions Identification card at the beginning of section.

For grommet options, see page 336.

Item	Model No.	W	D	H	K	R	Ship Wt	Cubic Ft	List Price
TRANSACTION RISER FOR DESKS/CREDENZAS	42-1472TR For Use with 72" Wide Desks Only	72	14	13 5/32	-	-	65	10.2	\$ 1768
	42-1466TR For Use with 66" Wide Desks Only	66	14	13 5/32	-	-	60	9.4	\$ 1605

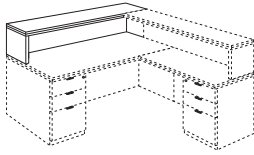
Description

- Freestanding Riser for Desks or Credenzas
- May Be Used in Conjunction with Return Risers or Bridge Risers
- 12" Clearance Below Riser Worksurface

TRANSACTION RISER FOR RETURNS	Left Ped	Right Ped	W	D	H	K	R	Ship Wt	Cubic Ft	List Price
	42-1470LU For Use with 36" Desks and 48" Returns	42-1470RU	70	14	13 5/32	-	-	50	10.2	\$ 1694
42-1464LU For Use with 30" Desks and 48" Returns	42-1464RU	64	14	13 5/32	-	-	45	9.1	\$ 1535	

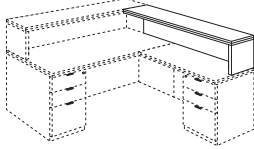
Description

- Must Be Used in Conjunction with a Desk Riser
- Grain Direction Runs Front to Back on Worksurface
- 12" Clearance Below Riser Worksurface

TRANSACTION RISER FOR BRIDGES	42-1480BU For Use with 36" Desks, 48" Bridge, and Credenza	80	14	13 5/32	-	-	50	4.8	\$ 1731
	42-1468BU For Use with 30" Desks, 42" Bridge, and Credenza	68	14	13 5/32	-	-	45	4.1	\$ 1545

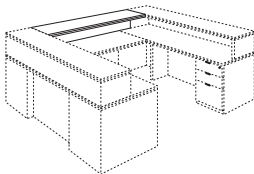

Description

- Must Be Used in Conjunction with Two Desk/Credenza Risers
- Grain Direction Runs Front to Back on Worksurface
- 12" Clearance Below Riser Worksurface

For ordering options, see back of Revolutions Identification card at the beginning of section.

For grommet options, see page 336.

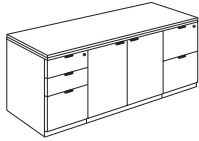
Item	Model No.	W	D	H	K	R	Ship Wt	Cubic Ft	List Price
STORAGE CREENZA	42-2472SC1	72	24	30	-	-	355	34.2	\$ 4520

Description

- Locking Pedestals
- Legal Width Pedestals
- Box/Box/File in Left Pedestal
- File/File in Right Pedestal
- Adjustable Storage Shelf Behind Doors

STORAGE CREENZA	42-2472SC2	72	24	30	-	-	355	34.2	\$ 4520
-----------------	------------	----	----	----	---	---	-----	------	---------

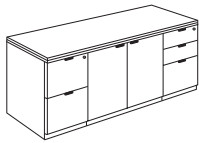
Description

- Locking Pedestals
- Legal Width Pedestals
- File/File in Left Pedestal
- Box/Box/File in Right Pedestal
- Adjustable Storage Shelf Behind Doors

STORAGE CREENZA	42-2472SC3	72	24	30	-	-	355	34.2	\$ 4520
-----------------	------------	----	----	----	---	---	-----	------	---------

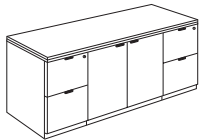
Description

- Locking Pedestals
- Legal Width Pedestals
- File/File in Pedestals
- Adjustable Storage Shelf Behind Doors

STORAGE CREENZA	42-2472SC4	72	24	30	-	-	355	34.2	\$ 4520
-----------------	------------	----	----	----	---	---	-----	------	---------

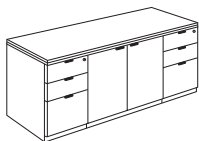
Description

- Locking Pedestals
- Legal Width Pedestals
- Box/Box/File in Pedestals
- Adjustable Storage Shelf Behind Doors

For ordering options, see back of Revolutions Identification card at the beginning of section.

Item	Model No.	W	D	H	K	R	Ship Wt	Cubic Ft	List Price
KNEESPACE CREDENZA	42-2472KC1	72	24	30	36	-	310	34.2	\$ 4085
	42-2466KC1	66	24	30	30	-	300	31.5	\$ 3798

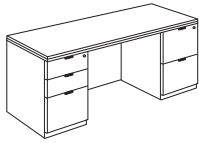
Description

- Locking Pedestals
- Legal Width Pedestals
- Box/Box/File in Left Pedestal
- File/File in Right Pedestal
- Grommet in Back Panel

KNEESPACE CREDENZA	42-2472KC2	72	24	30	36	-	310	34.	\$ 4085
	42-2466KC2	66	24	30	30	-	300	31.5	\$ 3798

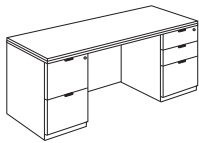
Description

- Locking Pedestals
- Legal Width Pedestals
- File/File in Left Pedestal
- Box/Box/File in Right Pedestal
- Grommet in Back Panel

KNEESPACE CREDENZA	42-2472KC3	72	24	30	36	-	310	34.2	\$ 4085
	42-2466KC3	66	24	30	30	-	300	31.5	\$ 3798

Description

- Locking Pedestals
- Legal Width Pedestals
- File/File in Pedestals
- Grommet in Back Panel

KNEESPACE CREDENZA	42-2472KC4	72	24	30	36	-	310	34.2	\$ 4085
	42-2466KC4	66	24	30	30	-	300	31.5	\$ 3798

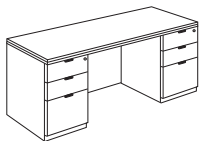
Description

- Locking Pedestals
- Legal Width Pedestals
- Box/Box/File in Pedestals
- Grommet in Back Panel

For ordering options, see back of Revolutions Identification card at the beginning of section.

For grommet options, see page 336.

Item	Model No.	W	D	H	K	R	Ship Wt	Cubic Ft	List Price
FOUR DRAWER LATERAL FILE WITH OVERHEAD STORAGE	42-2436L4D	36	24	71 1/2	-	-	320	41.2	\$ 5610

Description

- Locking Drawers
- Anti-Tilt System
- File Drawers Provide Legal or Letter Filing Front to Back or Side to Side
- 1/4" Thick Drawer Bottoms Allow for Storage Applications
- Overhead Doors Maximize Storage

FOUR DRAWER LATERAL FILE	42-2436L4	36	24	55	-	-	280	32.5	\$ 4422
--------------------------	-----------	----	----	----	---	---	-----	------	---------

Description

- Locking Drawers
- Anti-Tilt System
- File Drawers Provide Legal or Letter Filing

THREE DRAWER LATERAL FILE	42-2436L3	36	24	42	-	-	235	24.9	\$ 3656
---------------------------	-----------	----	----	----	---	---	-----	------	---------

Description

- Locking Drawers
- Anti-Tilt System
- File Drawers Provide Legal or Letter Filing

TWO DRAWER LATERAL FILE	42-2436L2	36	24	30	-	-	166	18.5	\$ 2635
-------------------------	-----------	----	----	----	---	---	-----	------	---------

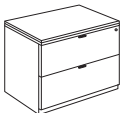
Description

- Locking Drawers
- Anti-Tilt System
- File Drawers Provide Legal or Letter Filing

For ordering options, see back of Revolutions Identification card at the beginning of section.

Item	Model No.	W	D	H	K	R	Ship Wt	Cubic Ft	List Price
MOBILE PEDESTAL BOX/BOX/FILE	42-1824MP	18	23	28 1/2	-	-	107	9.2	\$ 2075

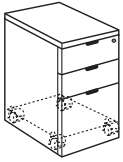
Description

- Locking Pedestal
- Legal Width Pedestal
- Box/Box/File in Pedestal
- Casters Allow for Easy Moving
- Fits Underneath 30" H Worksurfaces
- No Profile on Top

MOBILE PEDESTAL FILE/FILE	42-1824MP2	18	23	28 1/2	-	-	107	9.2	\$ 2075
------------------------------	------------	----	----	--------	---	---	-----	-----	---------

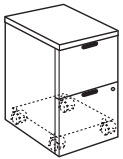
Description

- Locking Pedestal
- Legal Width Pedestal
- File/File in Pedestal
- Casters Allow for Easy Moving
- Fits Underneath 30" H Worksurfaces
- No Profile on Top

For ordering options, see back of Revolutions Identification card at the beginning of section.

Item	Model No.	W	D	H	K	R	Ship Wt	Cubic Ft	List Price
OPEN STORAGE SURFACE MOUNT HUTCH 	42-1472HN	72	14	40 ¹³ / ₁₆	-	-	180	29.8	\$ 2563
	42-1466HN	66	14	40 ¹³ / ₁₆	-	-	165	27.1	\$ 2399
	42-1436HN	36	14	40 ¹³ / ₁₆	-	-	130	16.7	\$ 1731

Description

- Grommet in Back Panel
- 24 ¹¹/₁₆" Clearance Below Shelf

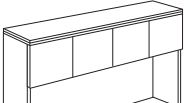
WOOD DOOR SURFACE MOUNT HUTCH 	42-1472HD	72	14	42	-	-	260	29.8	\$ 3798
	Four Doors								
	42-1466HD	66	14	42	-	-	238	27.1	\$ 3604
	Four Doors								
	42-1436HD	36	14	42	-	-	135	16.7	\$ 2113
	Two Doors								

Description

- Storage Behind Four Hinged Wood Doors
- Grommet in Back Panel
- 24 ¹¹/₁₆" Clearance Below Doors

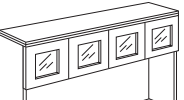
ACRYLIC DOOR SURFACE MOUNT HUTCH 	42-1472AH	72	14	42	-	-	260	29.8	\$ 4051
	Four Doors								
	42-1466AH	66	14	42	-	-	238	27.1	\$ 3762
	Four Doors								
	42-1436AH	36	14	42	-	-	135	16.7	\$ 2247
	Two Doors								

Description

- Storage Behind Four Hinged Acrylic Doors
- Grommet in Back Panel
- 24 ¹¹/₁₆" Clearance Below Doors

Options: Specify & Add

CA	Clear Acrylic Door Inserts	Included
FA	Frosted Acrylic Door Inserts	Included

For ordering options, see back of Revolutions Identification card at the beginning of section.

For tackboard and tasklights, see page 378.

Item	Model No.	W	D	H	K	R	Ship Wt	Cubic Ft	List Price
OPEN STORAGE WALL MOUNT HUTCH	42-1436WN	36	14	16 5/32	-	-	50	6.6	\$ 1109

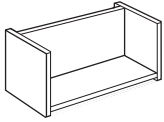
Description

- Open Storage
- Mounts to Wall with Mounting Bracket Included

NOTE: Indiana Furniture will not be liable for wall mount hutch units that are not properly installed.

WOOD DOOR WALL MOUNT HUTCH	42-1436WD	36	14	17 5/16	-	-	60	6.6	\$ 1580
-------------------------------	-----------	----	----	---------	---	---	----	-----	---------

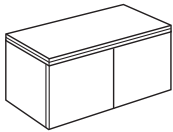
Description

- Storage Behind Two Hinged Wood Doors
- Mounts to Wall with Mounting Bracket Included

NOTE: Indiana Furniture will not be liable for wall mount hutch units that are not properly installed.

ACRYLIC DOOR WALL MOUNT HUTCH	42-1436AW	36	14	17 5/16	-	-	60	6.6	\$ 1716
----------------------------------	-----------	----	----	---------	---	---	----	-----	---------

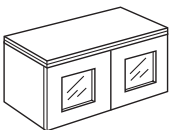
Description

- Mounts to Wall with Mounting Bracket Included
- Storage Behind Two Hinged Acrylic Doors

Options: Specify & Add

CA	Clear Acrylic Door Inserts	Included
FA	Frosted Acrylic Door Inserts	Included

NOTE: Indiana Furniture will not be liable for wall mount hutch units that are not properly installed.

For ordering options, see back of Revolutions Identification card at the beginning of section.

For tackboard and tasklights, see page 378.

Item	Model No.	W	D	H	K	R	Ship Wt	Cubic Ft	List Price
OPEN STORAGE CORNER HUTCH	42-4242CH	42	42	40 13/16	-	-	140	48.2	\$ 2023
	42-3636CH	36	36	40 13/16	-	-	130	35.9	\$ 1716

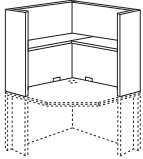
Description

- Storage Shelves
- Two Grommets
- 24 11/16" Clearance Below Shelf

TOP UNIT BOOKCASE	42-1436TU	36	14	42	-	-	100	15.3	\$ 1694
----------------------	-----------	----	----	----	---	---	-----	------	---------

Description

- Fixed Bottom Shelf
- One Adjustable Shelf
- 3/4" Thick Shelves

1/4 ROUND BOOKCASES	42-1472QR	14	14	71 1/2	-	-	130	10.8	\$ 2217
	Four Adjustable Shelves								
	42-2430QR	24	24	29 1/2	-	-	95	12.0	\$ 1917
	One Adjustable Shelf - For Use as Overhead Storage								

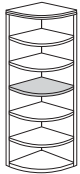
Description

- 3/4" Thick Shelves

BOOKCASES	42-3672BC	36	14	71 1/2	-	-	163	27.3	\$ 2735	
	Three Adjustable Shelves									
	42-3660BC	36	14	59 1/2	-	-	150	21.5	\$ 2271	
	Three Adjustable Shelves									
	42-3642BC	36	14	42	-	-	105	15.3	\$ 1806	
	Two Adjustable Shelves									
	42-3630BC	36	14	30	-	-	85	11.1	\$ 1535	
One Adjustable Shelf										

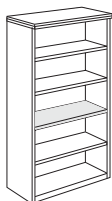
Description

- 3/4" Thick Shelves

For ordering options, see back of Revolutions Identification card at the beginning of section.

Item	Model No.	W	D	H	K	R	Ship Wt	Cubic Ft	List Price	
WOOD DOOR STORAGE TOWER	Hinged Left									
	Hinged Right									
	42-1418HL1	42-1418HR1	18	14	42	-	-	82	8.3	\$ 1850

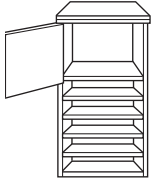
Description

- Storage Behind Wood Door
- Four Adjustable Shelves

Item	Model No.	W	D	H	K	R	Ship Wt	Cubic Ft	List Price	
ACRYLIC DOOR STORAGE TOWER	Hinged Left									
	Hinged Right									
	42-1418AHL1	42-1418AHR1	18	14	42	-	-	82	8.3	\$ 1917

Description

- Storage Behind Acrylic Door
- Four Adjustable Shelves

Options: Specify & Add

CA	Clear Acrylic Door Inserts	Included
FA	Frosted Acrylic Door Inserts	Included

PORTABLE TOWER UNIT	42-1418HH	18	12 1/4	22	-	-	45	4.4	\$ 1229
---------------------	-----------	----	--------	----	---	---	----	-----	---------

Description

- Four Adjustable Shelves

For ordering options, see back of Revolutions Identification card at the beginning of section.

Item	Model No.	W	D	H	K	R	Ship Wt	Cubic Ft	List Price	
WOOD DOOR STORAGE TOWER	Hinged Left									
	Hinged Right									
	42-1418HL2	42-1418HR2	18	14	42	-	-	82	8.3	\$ 1935

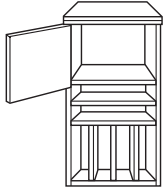
Description

- Storage Behind Wood Door
- Horizontal and Vertical Storage
- One Adjustable Shelf

ACRYLIC DOOR STORAGE TOWER	Hinged Left									
	Hinged Right									
	42-1418AHL2	42-1418AHR2	18	14	42	-	-	82	8.3	\$ 1999

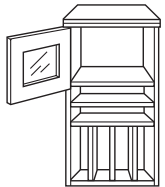

Description

- Storage Behind Acrylic Door
- Horizontal and Vertical Storage
- One Adjustable Shelf

Options: Specify & Add

CA	Clear Acrylic Door Inserts	Included
FA	Frosted Acrylic Door Inserts	Included

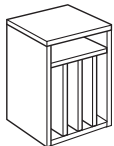
PORTABLE TOWER UNIT	42-1418HV	18	12 1/4	22	-	-	45	4.4	\$ 1307
---------------------	-----------	----	--------	----	---	---	----	-----	---------

Description

- Horizontal and Vertical Storage

For ordering options, see back of Revolutions Identification card at the beginning of section.

Item	Model No.	W	D	H	K	R	Ship Wt	Cubic Ft	List Price	
WARDROBE/STORAGE	Hinged Left									
	Hinged Right									
	42-1872WL	42-1872WR	18	24	71 1/2	-	-	179	23.0	\$ 3793

Description

- Fixed Top Shelf
- Coat Rod Under Fixed Shelf
- Three Adjustable Shelves can be Removed for Wardrobe Application

WARDROBE/STORAGE	42-3672WC	36	24	71 1/2	-	-	320	42.0	\$ 5396
------------------	-----------	----	----	--------	---	---	-----	------	---------

Description

- Fixed Top Shelf Behind Each Door
- Coat Rod Under Each Fixed Shelf
- Three Adjustable Shelves can be Removed for Wardrobe Application

For ordering options, see back of Revolutions Identification card at the beginning of section.

Item	Model No.	W	D	H	K	R	Ship Wt	Cubic Ft	List Price
WOOD DOORS VIDEO CABINET BOX/BOX/FILE	42-3672VC	36	24	71 1/2	-	-	300	42.0	\$ 5251

Description

- Top Section Includes an AV Shelf Behind Wood Doors
- Bottom Section Box/Box/File with Letter or Legal Filing Capabilities and Locking
- Holds up to 27" TV
- 170° Hinge on Doors
- Grommet in Back Panel

Options: Specify & Add

1-2516TV	Optional Factory Installed Slide Out and Swivel TV Tray	\$ 453
----------	---	--------

WOOD DOORS VIDEO CABINET FILE/FILE	42-3672VC2	36	24	71 1/2	-	-	300	42.0	\$ 5251
--	------------	----	----	--------	---	---	-----	------	---------



Description

- Top Section Includes an AV Shelf Behind Wood Doors
- Bottom Section File/File with Letter or Legal Filing Capabilities and Locking
- Holds up to 27" TV
- 170° Hinge on Doors
- Grommet in Back Panel

Options: Specify & Add

1-2516TV	Optional Factory Installed Slide Out and Swivel TV Tray	\$ 453
----------	---	--------

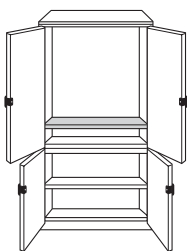
DOUBLE WOOD DOORS VIDEO CABINET	42-3672VCD	36	24	71 1/2	-	-	285	42.0	\$ 4473
------------------------------------	------------	----	----	--------	---	---	-----	------	---------

Description

- Top Section Includes an AV Shelf Behind Wood Doors
- Bottom Section has Storage Behind Wood Doors
- Holds up to 27" TV
- 170° Hinge on Doors
- Grommet in Back Panel

Options: Specify & Add

1-2516TV	Optional Factory Installed Slide Out and Swivel TV Tray	\$ 453
----------	---	--------

For ordering options, see back of Revolutions Identification card at the beginning of section.

Item	Model No.	W	D	H	K	R	Ship Wt	Cubic Ft	List Price
WOOD DOORS STORAGE CABINET BOX/BOX/FILE	42-3672SU1	36	24	71 1/2	-	-	300	42.0	\$ 5451

Description

- Top Section has Two Adjustable Shelves
- Bottom Section Box/Box/File with Letter or Legal Filing Capabilities and Locking
- 170° Hinge on Doors

WOOD DOORS STORAGE CABINET FILE/FILE	42-3672SU2	36	24	71 1/2	-	-	300	42.0	\$ 5451
--	------------	----	----	--------	---	---	-----	------	---------

Description

- Top Section has Two Adjustable Shelves
- Bottom Section File/File with Letter or Legal Filing Capabilities and Locking
- 170° Hinge on Doors

DOUBLE WOOD DOORS STORAGE CABINET	42-3672SUD	36	24	71 1/2	-	-	285	42.0	\$ 4673
--------------------------------------	------------	----	----	--------	---	---	-----	------	---------

Description

- Top Section has Two Adjustable Shelves
- Bottom Section has One Adjustable Shelf
- 170° Hinge on Doors

For ordering options, see back of Revolutions Identification card at the beginning of section.

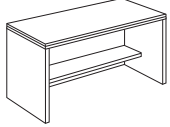
Item	Model No.	W	D	H	K	R	Ship Wt	Cubic Ft	List Price
COMPUTER WORK TABLE 	42-2454CW	54	24	30	52	-	135	25.9	\$ 2038
	42-2448CW	48	24	30	46	-	125	23.1	\$ 1880
	42-2436CW	36	24	30	34	-	115	17.6	\$ 1731
	42-2430CW	30	24	30	28	-	105	14.8	\$ 1574

Description

- Fixed Shelf is 12 ³/₈" Deep with a 20" Clearance
- Grommet in Back Panel

MAGAZINE TABLE 	42-2448MT	48	24	16	-	-	85	4.0	\$ 1535
--	-----------	----	----	----	---	---	----	-----	---------

Description

- Hardwood Legs
- Shipped KD

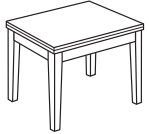
LAMP TABLE 	42-2430LT	30	24	22	-	-	75	2.5	\$ 1380
--	-----------	----	----	----	---	---	----	-----	---------

Description

- Shipped KD

For ordering options, see back of Revolutions Identification card at the beginning of section.

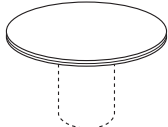
Item	Model No.	W	D	H	K	R	Ship Wt	Cubic Ft	List Price
CIRCULAR TABLE 	42-4848CT Accommodates 5 Chairs	48	48	1 ³ / ₁₆	-	-	61	5.7	\$ 2069
	42-4242CT Accommodates 4 Chairs	42	42	1 ³ / ₁₆	-	-	49	4.6	\$ 1741
	42-3636CT Accommodates 3-4 Chairs	36	36	1 ³ / ₁₆	-	-	35	3.4	\$ 1506

SIN 711-11

Description

- Top and Base Sold Separately

Item	Model No.	W	D	H	K	R	Ship Wt	Cubic Ft	List Price
CYLINDER BASE 	01-2020CB For Use on 48" and 42" Circular Tables	20	20	28 ¹ / ₂	-	-	134	11.1	\$ 977
	01-1616CB For Use on 36" Circular Table	16	16	28 ¹ / ₂	-	-	101	7.2	\$ 892

SIN 711-11

Description

- Veneer Cylinder Base
- Weighted for Stability
- 2 Wire Management Grommets Standard at Top with 8" Opening Standard in Bottom

Options: Specify & Add

GCB1S	Optional Grommet Top Edge (1)	\$	N/C
NOGC	Optional No Grommets At Top Edges	\$	N/C

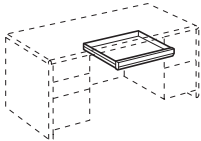
Item	Model No.	W	D	H	K	R	Ship Wt	Cubic Ft	List Price
CENTER DRAWER 	42-2122CD	22	21	2 ³ / ₄	-	-	13	2.1	\$ 346
	42-1622CD For Use with 36" D-Top Units and 42" P-Top Units with Modesty Panels	22	16	2 ³ / ₄	-	-	11	2.1	\$ 306

Description

- Center Drawer
- Hardwood Interior
- Built in Pen Tray

Options: Specify & Add

Factory Installed	\$	130
-------------------	----	-----

For ordering options, see back of Revolutions Identification card at the beginning of section.

REVOLUTIONS™ 4200 SERIES
 Modular Components

Item	Model No.	W	D	H	K	R	Ship Wt	Cubic Ft	List Price
BOW TOP WORKSURFACE 	42-4272BWT	72	42-36	1 ³ / ₁₆	-	-	125	7.1	\$ 1708
	42-3672BWT	72	36-30	1 ³ / ₁₆	-	-	110	6.2	\$ 1625

Description

- Shaped on Four Sides

DESK WORKSURFACE	42-3672TP	72	36	1 ³ / ₁₆	-	-	115	6.2	\$ 1252
------------------	-----------	----	----	--------------------------------	---	---	-----	-----	---------

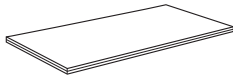

Description

- Shaped on Four Sides
- For Table Lift Options, See Accessories

For ordering options, see back of Revolutions Identification card at the beginning of section.

For grommet options, see page 336.

REVOLUTIONS™ 4200 SERIES
 Modular Components

Item	Model No.	W	D	H	K	R	Ship Wt	Cubic Ft	List Price
WORKSURFACE 30" DEEP 	42-3084TP	84	30	1 ³ / ₁₆	-	-	95	5.3	\$ 1222
	42-3078TP	78	30	1 ³ / ₁₆	-	-	90	4.9	\$ 1169
	42-3072TP	72	30	1 ³ / ₁₆	-	-	85	4.6	\$ 1116
	42-3066TP	66	30	1 ³ / ₁₆	-	-	80	4.2	\$ 1073
	42-3060TP	60	30	1 ³ / ₁₆	-	-	75	3.8	\$ 1027
	42-3054TP	54	30	1 ³ / ₁₆	-	-	70	3.4	\$ 990
	42-3048TP	48	30	1 ³ / ₁₆	-	-	60	3.1	\$ 953
	42-3042TP	42	30	1 ³ / ₁₆	-	-	55	2.7	\$ 915

Description

- Shaped on Four Sides
- For Use on 30" Deep Pedestals
- When 30" Deep Modular Tops have a Kneespace of 60" or Greater, a Support T Panel is Needed to Support the Top
- For Table Lift Options, See Accessories

For ordering options, see back of Revolutions Identification card at the beginning of section.

For grommet options, see page 336.

REVOLUTIONS™ 4200 SERIES
 Modular Components

Item	Model No.	W	D	H	K	R	Ship Wt	Cubic Ft	List Price
WORKSURFACE 24" DEEP 	42-24108TP	108	24	1 ³ / ₁₆	-	-	110	5.5	\$ 1768
	42-24102TP	102	24	1 ³ / ₁₆	-	-	105	5.2	\$ 1694
	42-2496TP	96	24	1 ³ / ₁₆	-	-	100	4.9	\$ 1236
	42-2490TP	90	24	1 ³ / ₁₆	-	-	95	4.6	\$ 1162
	42-2484TP	84	24	1 ³ / ₁₆	-	-	90	4.3	\$ 1081
	42-2478TP	78	24	1 ³ / ₁₆	-	-	85	4.0	\$ 1035
	42-2472TP	72	24	1 ³ / ₁₆	-	-	80	3.7	\$ 998
	42-2466TP	66	24	1 ³ / ₁₆	-	-	75	3.4	\$ 960
	42-2460TP	60	24	1 ³ / ₁₆	-	-	70	3.1	\$ 930
	42-2454TP	54	24	1 ³ / ₁₆	-	-	65	2.8	\$ 877
	42-2448TP	48	24	1 ³ / ₁₆	-	-	55	2.5	\$ 841
	42-2442TP	42	24	1 ³ / ₁₆	-	-	50	2.2	\$ 801
	42-2436TP	36	24	1 ³ / ₁₆	-	-	45	1.9	\$ 780
	42-2430TP	30	24	1 ³ / ₁₆	-	-	36	1.6	\$ 748
	42-2418TP	18	24	1 ³ / ₁₆	-	-	28	1.0	\$ 689

Description

- Shaped on Four Sides
- For Use on 24" Deep Pedestals/Files
- When 24" Deep Modular Tops have a Kneespace of 60" or Greater, a Support T Panel is Needed to Support the Top
- For Table Lift Options, See Accessories

For ordering options, see back of Revolutions Identification card at the beginning of section.

For grommet options, see page 336.

REVOLUTIONS™ 4200 SERIES
 Modular Components

Item	Model No.	W	D	H	K	R	Ship Wt	Cubic Ft	List Price
MODULAR RETURN TOP 	42-2472RTP	72	24	1 ³ / ₁₆	-	-	80	3.7	\$ 998
	42-2466RTP	66	24	1 ³ / ₁₆	-	-	75	3.4	\$ 960
	42-2460RTP	60	24	1 ³ / ₁₆	-	-	70	3.1	\$ 930
	42-2454RTP	54	24	1 ³ / ₁₆	-	-	65	2.8	\$ 877
	42-2448RTP	48	24	1 ³ / ₁₆	-	-	55	2.5	\$ 841
	42-2442RTP	42	24	1 ³ / ₁₆	-	-	50	2.2	\$ 801
	42-2436RTP	36	24	1 ³ / ₁₆	-	-	45	1.9	\$ 780

Description

- Shaped on Four Sides
- For Use on 24" Deep Pedestals/Files
- Grain Direction Runs Front to Back on Worksurface
- When 24" Deep Modular Tops have a Kneespace of 60" or Greater, a Support T Panel is Needed to Support the Top
- For Table Lift Options, See Accessories

For ordering options, see back of Revolutions Identification card at the beginning of section.

For grommet options, see page 336.

Item	Model No.	W	D	H	K	R	Ship Wt	Cubic Ft	List Price	
P-TOP WITH CYLINDER BASE	Left Top	Right Top								
	42-4272TL	42-4272TR	72	42-36	30	-	-	120	9.4	\$ 3387
	42-3672TL	42-3672TR	72	36-30	30	-	-	115	6.2	\$ 3310

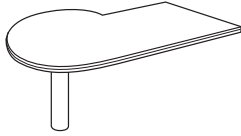
Description

- Metal Cylinder Base - 4 1/2" Diameter. Must Specify: Black or Aluminum.
- Shipped KD

D-TOP WITH CYLINDER BASE	42-3672DR	72	36	30	-	-	115	6.2	\$ 2720
	42-3072DR	72	30	30	-	-	110	4.6	\$ 2593
	42-3060DR	60	30	30	-	-	105	3.8	\$ 2410

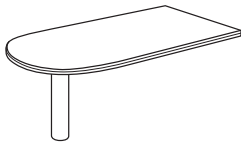

Description

- Metal Cylinder Base - 4 1/2" Diameter. Must Specify: Black or Aluminum.
- Shipped KD

For ordering options, see back of Revolutions Identification card at the beginning of section.

For grommet options, see page 336.

REVOLUTIONS™ 4200 SERIES
 Modular Components

Item	Model No.	W	D	H	K	R	Ship Wt	Cubic Ft	List Price
COMPONENT PEDESTAL BOX/BOX/FILE 	42-3618PD1	18	36	28 5/16	-	-	125	13.6	\$ 2264
	42-3018PD1	18	30	28 5/16	-	-	105	11.6	\$ 2150
	42-2418PD1	18	24	28 5/16	-	-	85	9.5	\$ 2053

Description

- Locking
- Box/Box/File
- Finished Back

COMPONENT PEDESTAL FILE/FILE 	42-3618PD2	18	36	28 5/16	-	-	125	13.6	\$ 2264
	42-3018PD2	18	30	28 5/16	-	-	105	11.6	\$ 2150
	42-2418PD2	18	24	28 5/16	-	-	85	9.5	\$ 2053

Description

- Locking
- File/File
- Finished Back

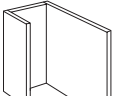
COMPONENT PEDESTAL SHELL 	42-3618PD3	18	36	28 5/16	-	-	46	11.7	\$ 1005
	42-3018PD3	18	30	28 5/16	-	-	43	9.7	\$ 923
	42-2418PD3	18	24	28 5/16	-	-	41	7.6	\$ 841

Description

- Used to Complete Single Pedestal Configuration
- Can be Used as Left Pedestal Shell or Right Pedestal Shell
- Finished Back

For ordering options, see back of Revolutions Identification card at the beginning of section.

REVOLUTIONS™ 4200 SERIES
 Modular Components

Item	Model No.	W	D	H	K	R	Ship Wt	Cubic Ft	List Price
------	-----------	---	---	---	---	---	---------	----------	------------

COMPONENT COMPUTER PEDESTAL	Hinged Left	Hinged Right	18	24	28 5/16	-	-	65	9.0	\$ 2042
	42-2418PD6L	42-2418PD6R								

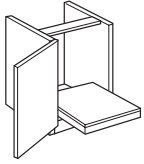
Description

- Sliding Pull Out Shelf for CPU
- Inside Dimensions 19 3/4 H x 16 3/8 W x 22 3/8 D
- Open Back

COMPONENT OPEN BOOKCASE PEDESTAL	42-2418OP	18	24	28 5/16	-	-	60	9.0	\$ 1801
----------------------------------	-----------	----	----	---------	---	---	----	-----	---------

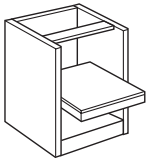
Description

- 3 Position Adjustable Pull Out Shelf
- 22" Deep Shelf
- Finished Back

COMPONENT BOOKCASE PEDESTAL	42-2418OF	18	24	28 5/16	-	-	65	9.0	\$ 1788
-----------------------------	-----------	----	----	---------	---	---	----	-----	---------

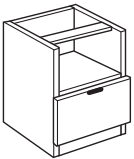
Description

- Top Section is Open for Storage
- Bottom Section has Non-Locking File Drawer
- Finished Back

COMPONENT DOOR BOOKCASE PEDESTAL	Hinged Left	Hinged Right	18	24	28 5/16	-	-	60	9.0	\$ 1765
	42-2418PD4L	42-2418PD4R								

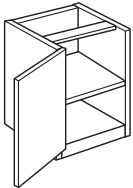
Description

- One Adjustable Shelf
- Finished Back

For ordering options, see back of Revolutions Identification card at the beginning of section.

Item	Model No.	W	D	H	K	R	Ship Wt	Cubic Ft	List Price
COMPONENT LATERAL FILE FILE/FILE	42-2436LF1	36	24	28 5/16	-	-	142	17.5	\$ 2427

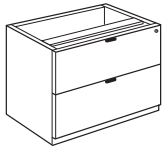
Description

- Locking
- Anti-Tilt System
- Finished Back

COMPONENT LATERAL FILE BOX/BOX/FILE/LATERAL	42-2436LF2	36	24	28 5/16	-	-	142	17.5	\$ 2720
--	------------	----	----	---------	---	---	-----	------	---------

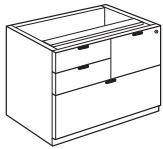
Description

- Locking File Drawers
- Finished Back

COMPONENT LATERAL FILE FILE/FILE/LATERAL	42-2436LF4	36	24	28 5/16	-	-	142	17.5	\$ 2720
---	------------	----	----	---------	---	---	-----	------	---------

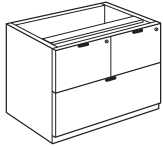
Description

- Locking File Drawers
- Finished Back

COMPONENT LATERAL FILE OPEN SHELF/LATERAL	42-2436LF6	36	24	28 5/16	-	-	98	17.5	\$ 2480
--	------------	----	----	---------	---	---	----	------	---------

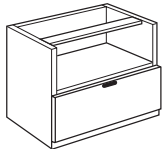

Description

- Non-Locking File Drawer
- Finished Back

For ordering options, see back of Revolutions Identification card at the beginning of section.

REVOLUTIONS™ 4200 SERIES
 Modular Components

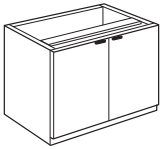
Item	Model No.	W	D	H	K	R	Ship Wt	Cubic Ft	List Price
COMPONENT DOOR BOOKCASE	42-2436DB	36	24	28 5/16	-	-	105	17.5	\$ 2113

Description

- Adjustable Shelf
- Shelf 12 1/8" Deep
- Finished Back

COMPONENT OPEN BOOKCASE	42-2436OP	36	24	28 5/16	-	-	95	17.5	\$ 2246
-------------------------	-----------	----	----	---------	---	---	----	------	---------

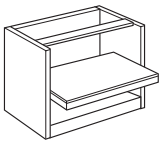
Description

- 3 Position Adjustable Pull Out Shelf
- 22" Deep Shelf
- Finished Back

COMPONENT FOUR DRAWER FILE	42-2436QF	36	24	53 13/16	-	-	205	31.6	\$ 4059
----------------------------	-----------	----	----	----------	---	---	-----	------	---------

Description

- Four File Drawers
- Locking
- Anti-Tilt System
- Finished Back

COMPONENT THREE DRAWER FILE	42-2436TF	36	24	40 13/16	-	-	180	24.3	\$ 3272
-----------------------------	-----------	----	----	----------	---	---	-----	------	---------

Description

- Three File Drawers
- Locking
- Anti-Tilt System
- Finished Back

For ordering options, see back of Revolutions Identification card at the beginning of section.

REVOLUTIONS™ 4200 SERIES
 Modular Components

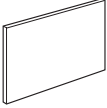
Item	Model No.	W	D	H	K	R	Ship Wt	Cubic Ft	List Price
COMPONENT MODESTY PANEL 	42-5428BP	54	3/4	28 5/16	-	-	46	3.7	\$ 704
	42-4828BP	48	3/4	28 5/16	-	-	41	3.3	\$ 666
	42-4228BP	42	3/4	28 5/16	-	-	36	2.9	\$ 628
	42-3628BP	36	3/4	28 5/16	-	-	31	2.6	\$ 600
	42-3028BP	30	3/4	28 5/16	-	-	25.5	2.1	\$ 568
	42-2428BP	24	3/4	28 5/16	-	-	20.5	1.7	\$ 547
	42-1828BP	18	3/4	28 5/16	-	-	15.5	1.4	\$ 533

Description

- Modesty Panels are Used in Conjunction with Component Worksurfaces and Component Pedestals and Files to Create a Fully Enclosed Kneespace in Desk, Bridge, Return, or Credenza Applications.
- Shipped with Attachment Hardware
- Finished on Both Sides

Options: Specify & Add

1-GRMT	Optional Top-Center Grommet	\$	48
--------	-----------------------------	----	----

For ordering options, see back of Revolutions Identification card at the beginning of section.

Item	Model No.	W	D	H	K	R	Ship Wt	Cubic Ft	List Price
SUPPORT T	42-1010SP	10	10	28 5/16	-	-	20	.7	\$ 459

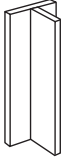
Description

- Support "T" is Required for Added Support When Open Kneespace Area is 60" or Greater Under Worksurfaces
- Finished on All Sides

GANGING BRACKET	42-0104GB	4	1 1/2	1 1/4	-	-	1	-	\$ 36
-----------------	-----------	---	-------	-------	---	---	---	---	-------

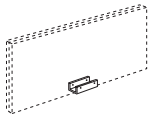
Description

- Attaches Pedestals and Files without Defacing Visible Areas of Units for Future Reconfigurability
- Optional Ganging Brackets can be Used to Attach Two or More Pedestals or Files in Side by Side Configuration

For ordering options, see back of Revolutions Identification card at the beginning of section.

Item	Model No.	W	D	H	K	R	Ship Wt	Cubic Ft	List Price
EXECUTIVE "L"	42-1	72	84	30	-	-	482	74.8	\$ 6691

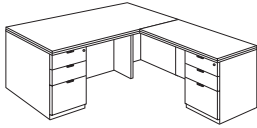

Consists of:	Qty		
42-3672LP1	1	• Left Pedestal Desk	\$ 3852
42-2448RF1	1	• Executive Right Return	\$ 2839

EXECUTIVE "U"	42-4	72	114	30	-	-	658	97.4	\$ 9934
---------------	------	----	-----	----	---	---	-----	------	---------

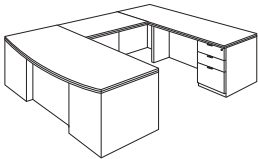

Consists of:	Qty		
42-4272LP1	1	• Bow Top Left Pedestal Desk	\$ 4885
42-2448UF	1	• Executive Bridge Unit	\$ 1587
42-2472RC1	1	• Right Pedestal Credenza	\$ 3462

All pedestal desks shown as left.
 All returns shown as right.

For ordering options, see back of Revolutions Identification card at the beginning of section.

Item	Model No.	W	D	H	K	R	Ship Wt	Cubic Ft	List Price
EXECUTIVE "U" P-TOP	42-6	72	114	30	-	-	491	97.4	\$ 8718

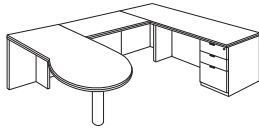
Consists of:
Qty

42-4272PL	1	• P-Top with End Support	\$ 3669
42-2448UF	1	• Executive Bridge Unit	\$ 1587
42-2472RC1	1	• Right Pedestal Credenza	\$ 3462

EXECUTIVE WORKSTATION	42-11	108	108	72	-	-	1048	157.4	\$ 18276
-----------------------	-------	-----	-----	----	---	---	------	-------	----------

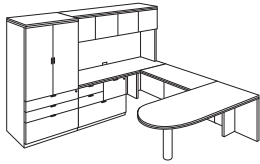
Consists of:
Qty

42-3672DU	1	• D-Top with End Panel Support	\$ 3081
42-2448UF	1	• Executive Bridge Unit	\$ 1587
42-1472HD	1	• Door Hutch	\$ 3798
42-2472TP	1	• Component Top	\$ 998
42-2418PD3	1	• Component Credenza Pedestal Shell	\$ 841
42-2436LF2	1	• Component Lateral File	\$ 2720
42-3672VC	1	• Video Cabinet	\$ 5251

For ordering options, see back of Revolutions Identification card at the beginning of section.

Item	Model No.	W	D	H	K	R	Ship Wt	Cubic Ft	List Price
EXECUTIVE WORKSTATION	42-13	72	114	72	-	-	958	158.4	\$ 15793

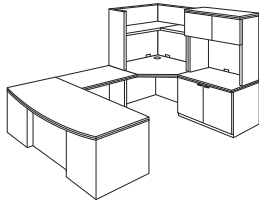

Consists of:		Qty		
42-4272LP2	1 • Bow Top Left Pedestal Desk	1		\$ 4885
42-2436UF	1 • Executive Bridge Unit	1		\$ 1483
42-3636CU	1 • Corner Unit	1		\$ 2703
42-2436TP	1 • Component Top	1		\$ 780
42-2436DB	1 • Component Door Bookcase	1		\$ 2113
42-3636CH	1 • Corner Hutch	1		\$ 1716
42-1436HD	1 • Door Hutch	1		\$ 2113

TEAM WORKSTATION	42-14	144	144	72	-	-	2500	314.7	\$ 50800
------------------	-------	-----	-----	----	---	---	------	-------	----------

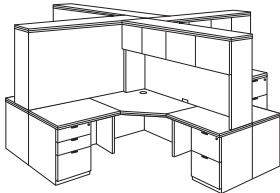

Consists of:		Qty		
42-1472HD	4 • Door Hutch	4		\$ 15192
42-3636CU	4 • Corner Unit	4		\$ 10812
42-2436TP	8 • Component Top	8		\$ 6240
42-2418PD1	4 • Component Pedestal-Box/Box/File	4		\$ 8212
42-2418PD2	4 • Component Pedestal-File/File	4		\$ 8212
42-1828BP	4 • Component Back Panel	4		\$ 2132

For ordering options, see back of Revolutions Identification card at the beginning of section.

Item	Model No.	W	D	H	K	R	Ship Wt	Cubic Ft	List Price
EXECUTIVE WORKSTATION	42-15	150	114	72	-	-	1580	213.9	\$ 28409

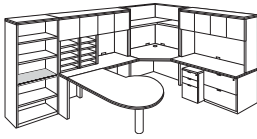

Consists of:	Qty		
42-3672BC	1	• Bookcase	\$ 2735
42-1418HL1	1	• Tower Unit Hinged Left	\$ 1850
42-1418HR1	1	• Tower Unit Hinged Right	\$ 1850
42-1436HD	1	• Door Hutch	\$ 2113
42-4242CH	1	• Corner Hutch	\$ 2023
42-1472HD	1	• Door Hutch	\$ 3798
42-2436LF1	1	• Component Lateral File	\$ 2427
42-1824MP	1	• Mobile Pedestal	\$ 2075
42-2472TP	2	• Component Top	\$ 1996
42-4242CU	1	• Corner Unit (Keyboard Tray Not Included)	\$ 2855
42-2418PD3	1	• Pedestal Shell	\$ 841
42-4272TR	1	• P-Top with 4" Diameter Black Metal Base	\$ 3387
42-1010SP	1	• Support "T"	\$ 459

EXECUTIVE OFFICE	42-16	144	114	72	-	-	1535	191.4	\$ 28324
------------------	-------	-----	-----	----	---	---	------	-------	----------

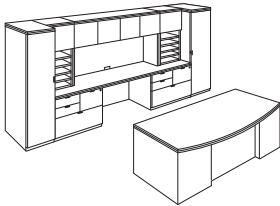

Consists of:	Qty		
42-4272DP1	1	• Bow Top Double Pedestal Desk	\$ 5432
42-1872WL	1	• Wardrobe Cabinet Hinged Left	\$ 3793
42-1872WR	1	• Wardrobe Cabinet Hinged Right	\$ 3793
42-1418HL1	1	• Tower Unit Hinged Left	\$ 1850
42-1418HR1	1	• Tower Unit Hinged Right	\$ 1850
42-1472HD	1	• Door Hutch	\$ 3798
42-24108TP	1	• Component Top	\$ 1768
42-2436LF2	2	• Component Lateral File	\$ 5440
42-3628BP	1	• Modesty Panel	\$ 600

For ordering options, see back of Revolutions Identification card at the beginning of section.

Item	Model No.	W	D	H	K	R	Ship Wt	Cubic Ft	List Price
RECEPTION WORKSTATION	42-17	180	96	72	-	-	1965	229.3	\$ 40148

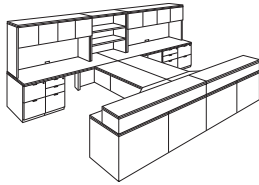
Consists of:
Qty

42-1472HD	2	• Door Hutch	\$ 7596
42-1436TU	1	• Top Unit Bookcase	\$ 1694
42-1472TR	2	• Transaction Riser	\$ 3536
42-3636CU	2	• Corner Unit	\$ 5406
42-2436UF	2	• Executive Bridge Unit	\$ 2966
42-2490TP	2	• Component Top	\$ 2324
42-2418PD3	2	• Pedestal Shell	\$ 1682
42-1828BP	2	• Modesty Panel	\$ 1066
42-2436TP	2	• Component Top	\$ 1560
42-2418PD1	4	• Component Pedestal	\$ 8212
42-2418PD2	2	• Component Pedestal	\$ 4106

RECEPTION WORKSTATION	42-19	72	132	42	-	-	1100	145.9	\$ 17695
-----------------------	-------	----	-----	----	---	---	------	-------	----------

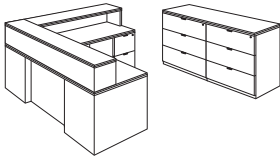
Consists of:
Qty

42-3672LP1	1	• Left Pedestal Desk	\$ 3852
42-2448RF2	1	• Executive Right Return	\$ 2839
42-1472TR	1	• Transaction Riser for Desk	\$ 1768
42-1470RU	1	• Transaction Riser for Return	\$ 1694
42-2436TF	2	• Component Three Drawer Files	\$ 6544
42-2472TP	1	• Component Top	\$ 998

Item	Model No.	W	D	H	K	R	Ship Wt	Cubic Ft	List Price
EXECUTIVE "L" COCKPIT SHELL BOW TOP	42-20	78	84	30	-	-	470	83.0	\$ 6877

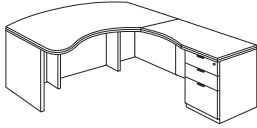

Consists of:	Qty		
42-4278CLSH	1	• Executive Left Cockpit Shell Desk	\$ 3919
42-2442CRF1	1	• Cockpit Right Return	\$ 2958

NOTE: Tops are non-reconfigurable.

EXECUTIVE "U" COCKPIT SHELL	42-24	78	98	30	-	-	665	111.0	\$ 11083
-----------------------------	-------	----	----	----	---	---	-----	-------	----------

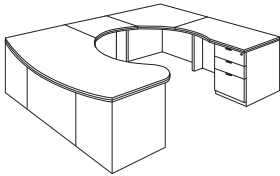

Consists of:	Qty		
42-4278CLSH	1	• Executive Left Cockpit Shell	\$ 3919
42-2420CUF	1	• Cockpit Bridge	\$ 1380
42-3636CCU	1	• Cockpit Corner Unit	\$ 2826
42-2442CRF1	1	• Cockpit Right Return	\$ 2958

NOTE: Tops are non-reconfigurable.

HOW PEDESTALS AND FILES ARE ATTACHED TO TOPS

Pedestals and files are attached to tops by metal to metal fasteners. This is for the future reconfigurability of units. The diagram shows how tops are fastened with metal inserts into each top. Metal inserts are placed in all possible locations of the top for any pedestal or file configuration. Post and Cam systems are also used for the attachment of tops to pedestals and files.

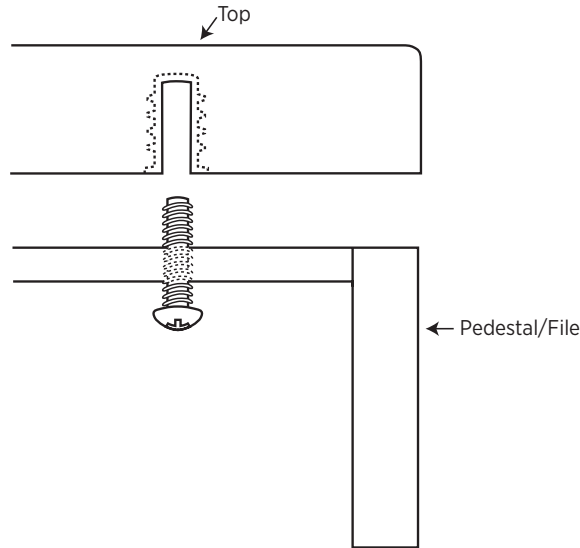

HOW DESK MODESTY PANELS ARE ATTACHED TO PEDESTALS

Desk modesty panels are attached to pedestals by metal brackets. The diagram shows the bracket connecting the modesty panel to the inside of the pedestal in the kneespace. When ordering assembled units, these brackets are already used to assemble the unit. When specifying component modesty panels, two brackets will ship with each modesty panel for field assembly.

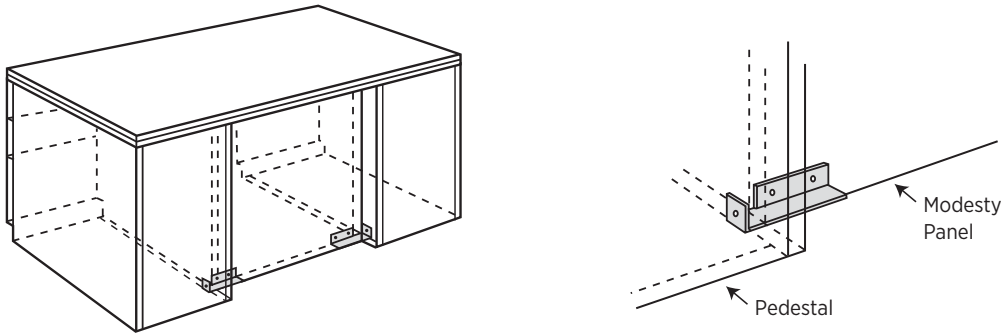

HOW CREDENZA/RETURN MODESTY PANELS ARE ATTACHED

Credenza/Return modesty panels are attached to pedestals and files by metal brackets. The diagram shows the bracket connecting the modesty panel to the inside of the pedestal or file in the kneespace. When ordering assembled units, these brackets are already used to assemble the unit. When specifying component modesty panels, two brackets will ship with each modesty panel for field assembly.

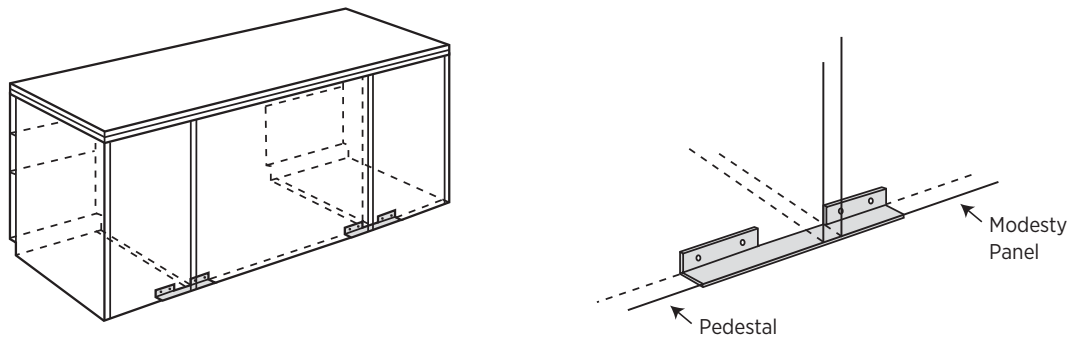

TACKBOARD: SURFACE MOUNTED HUTCHES – 23 7/8" TALL

Size	Model #	COM ydg	COM, Grade 1, 2 or 3 List Price	Grade 4 List Price	Grade 5 List Price	Grade 6 List Price	Grade 7 List Price	Grade 8 List Price	Grade 9 List Price	Grade 10 List Price
36"	TB-4236H	1.25	\$ 242	\$ 355	\$ 406	\$ 463	\$ 538	\$ 617	\$ 713	\$ 821
66"	TB-4266H	2.0	\$ 336	\$ 518	\$ 600	\$ 690	\$ 810	\$ 937	\$ 1090	\$ 1263
72"	TB-4272H	2.25	\$ 357	\$ 561	\$ 653	\$ 755	\$ 890	\$ 1033	\$ 1204	\$ 1399

TACKBOARD: WALL MOUNTED HUTCHES – 21 7/8" TALL

Size	Model #	COM ydg	COM, Grade 1, 2 or 3 List Price	Grade 4 List Price	Grade 5 List Price	Grade 6 List Price	Grade 7 List Price	Grade 8 List Price	Grade 9 List Price	Grade 10 List Price
36"	TB-0136W	1.25	\$ 274	\$ 387	\$ 438	\$ 495	\$ 570	\$ 649	\$ 744	\$ 853

TACKBOARD: CORNER UNIT HUTCHES – 17 3/4" TALL

Size	Model #	COM ydg	COM, Grade 1, 2 or 3 List Price	Grade 4 List Price	Grade 5 List Price	Grade 6 List Price	Grade 7 List Price	Grade 8 List Price	Grade 9 List Price	Grade 10 List Price
36"	TB-4236CH	2.5	\$ 398	\$ 625	\$ 728	\$ 841	\$ 990	\$ 1149	\$ 1340	\$ 1556
42"	TB-4242CH	2.5	\$ 407	\$ 634	\$ 737	\$ 850	\$ 999	\$ 1159	\$ 1349	\$ 1565

TASKLIGHTS – Includes 3 Wire Management Grommets

Model #	Size	Description	List Price
TL-0824	22 1/2" x 1 5/8" x 7/8"	84-LED, 7 Watts	\$ 234
TL-0848	47 1/2" x 1 5/8" x 7/8"	240-LED, 18 Watts	\$ 280

PhoenixTM

Casegoods Collection

How to Order

MODEL NO.	DESCRIPTION
21-3672BDP	Finish AW
	Top Surface W
	Pull AFC

All options must be labeled and specified.



Specifications

veneER

Exposed surfaces feature select grade sliced American Black Walnut hardwood carefully selected and matched to assure proper balance and consistency.

TOPS

Wood veneer tops are 5-ply balanced construction and 1½" thick. High pressure laminate tops are 3-ply balanced construction and 1½" thick. Grain direction runs left to right unless noted.

CHASSIS CONSTRUCTION

Veneer chassis are fastened by screws, glue, and heavy-duty metal fasteners assuring maximum strength. Units feature finished backs unless otherwise noted. All units ship assembled unless noted. All units ship with leveling glides.

DRAWERS

All drawer fronts are 3-ply construction, ¾" thick with matched wood grain. Drawer sides, back and front are wood grain vinyl wrapped, ½" thick. Box and file drawers have ¼" thick hardboard bottoms. Lateral file drawers feature ¼" thick bottoms. 5-sided drawer construction allows for easy removal of drawer fronts.

DRAWER SUSPENSIONS

All drawers have full extension, progressive action slides with precision steel ball bearings. All suspensions have a lifetime warranty.

FILING HARDWARE

All file drawers are standard with filing systems designed to accommodate a variety of filing requirements. Letter width file drawers provide letter filing front to back, and letter or legal filing side to side. Lateral file drawers provide legal or letter filing front to back or side to side.

LOCKING

All desks, credenzas, returns, and files feature standard locking. Removable lock cores allow for units to be re-keyed at a later date if required. Units ship randomly keyed as standard.

CORD MANAGEMENT

Route power and data cables away from the worksurface through inherent grommet placement. Grommets may be ordered in the tops of all desks, returns, bridges, and credenzas. All desks and returns have standard wire openings from inside the pedestal to the kneespace allowing quick access to technology below. Additionally, returns, bridge units, kneespace credenzas, and hutch units have standard grommets available in backpanels. Grommets are also standard in the tops of corner units. See page 426 for all optional grommet locations.

Undersurface tracks are available for additional cord management. Silver grommets are also available. See Accessories.

FINISH

The multi-step finish process used by Indiana Furniture provides years of lasting beauty. High quality finish materials offer distinctive grain clarity, superior resistance to normal wear, and ease of maintenance.

Finish Options

WOOD VENEER (W) OR LAMINATE (P) TOPS – MUST SPECIFY



Artisan Walnut
AW



Legacy Walnut
LW



Harvest Walnut
HW

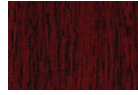

Mahogany on Walnut
MW



Columbian Walnut
CO



Presidential Walnut
PW



Espresso Walnut
EW

Available in High Pressure Laminate Tops. (P)

Edge



Phoenix
O

All Phoenix tops are standard with a transitional edge detail.

Pull Options



Aluminum Arc
AAC



Aluminum Focus
AFC



Aluminum Orbit
AOR



Aluminum Swag
ASW



Aluminum Buckle
ABU



Black Arc
BAC



Black Focus
BFC



Black Orbit
BOR



Black Swag
BSW



Black Buckle
BBU

INTERIOR DRAWER DIMENSIONS

PHOENIX 2100 INTERIOR DRAWER DIMENSIONS

Item	Drawers	W	L	D
21-3672RP	Box	12 1/8	16 3/16	3 1/2
21-3672LP	File	12 1/8	16 3/16	9 5/16
21-3672DP				
21-3672BRP				
21-3672BLP				
21-3672BDP				
21-3066RP				
21-3066LP				
21-3066DP				
21-3060DP				
21-2448RF2				
21-2448RF1				
21-2448LF2				
21-2448LF1				
21-2442RF2				
21-2442RF1				
21-2442LF2				
21-2442LF1				
21-2072SC				
21-2072RC2				
21-2072RC1				
21-2072LC2				
21-2072LC1				
21-2072KC				
21-2066SC				
21-2066RC2				
21-2066RC1				
21-2066LC2				
21-2066LC1				
21-2066KC				
21-2036L4	File	30 1/2	15 1/16	9 7/32
21-2036L2				
21-2072RL				
21-2072LL				
21-2066RL				
21-2066LL				
21-2472RMR	Box	16 3/16	12 1/8	3 1/2
21-2472LMR	Upper File	12 1/8	16 3/16	9 1/4
21-2072RMF	Lat File	31 1/2	15 1/16	9 7/32
21-2072LMF				
21-2066RMF				
21-2066LMF				
21-3672TD	Tray	30 11/16	15 3/16	1 3/4
21-3066TD				
21-1622CD	Center	18 15/16	14 15/16	1 3/4

FILING CAPABILITIES

12 1/8 x 16 3/16

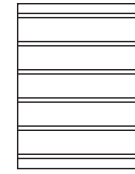

Letter Front to Back

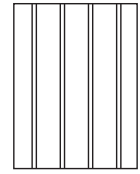

Legal Side to Side

30 1/2 x 15 1/16

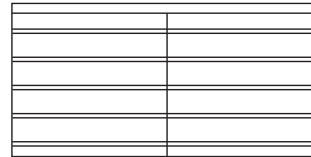

2 Rows Letter Front to Back

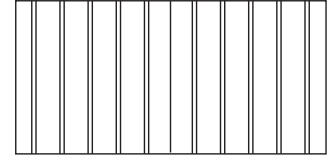

1 Row Letter or Legal Side to Side

31 1/2 x 15 1/16

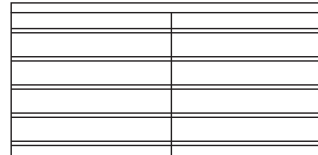

2 Rows Letter or Legal Front to Back

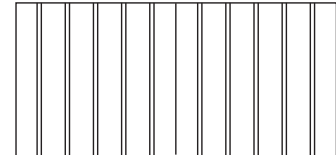

1 Row Letter or Legal Side to Side

GROMMET LOCATIONS

Add upcharge of \$48 list for each grommet.

Specify grommet locations.

- GL - Grommet Left
- GC - Grommet Center
- GR - Grommet Right

Example: 21-3066LP-GR (Grommet Right)

Grommets may be ordered in non-standard locations. Please call Customer Service to assist with how to order and additional lead time requirements.

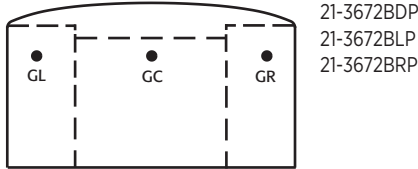

GL/GR - 6" from ends, 23" from user side.
GC - 23" from user side.

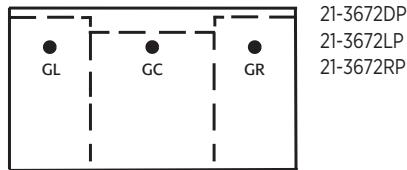

GL/GR - 6" from ends, 23" from user side.
GC - 23" from user side.

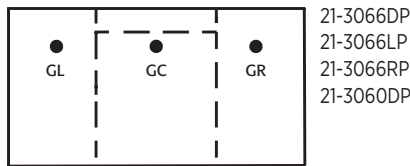

GL/GR - 6" from ends, 23" from user side.
GC - 23" from user side.

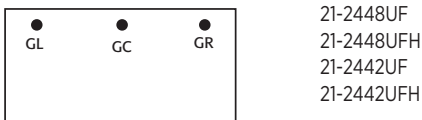

GL/GR - 6" from ends, 20" from user side.
GC - 20" from user side.

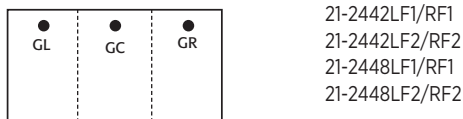

GL/GR - 6" from ends, 20" from user side.
GC - 20" from user side.

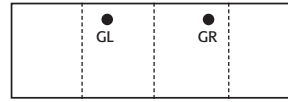
GROMMET LOCATIONS - CONTINUED

- | | |
|-----------------|-----------------|
| 21-2072KC | 21-2072LMF/RMF* |
| 21-2072LC1/RC1 | 21-2066KC |
| 21-2072LC2/RC2 | 21-2066LC1/RC1 |
| 21-2072LL/RL* | 21-2066LC2/RC2 |
| 21-2472LMR/RMR* | 21-2066LL/RL* |
| | 21-2066LMF/RMF* |

GL/GR - 19 1/2" from ends, 17 3/8" from user side.
*Grommets are only available opposite the pedestal.

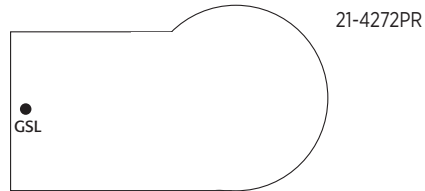

GSL - 18" from approach or seated side, 6" from end.

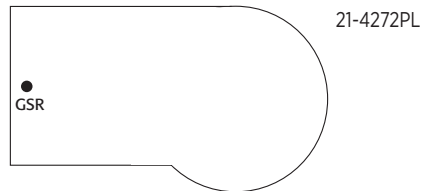

GSR - 18" from approach or seated side, 6" from end.

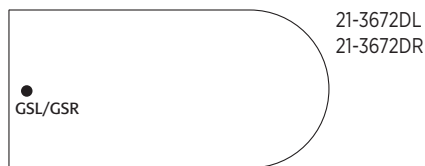

GSL - 18" from approach or seated side, 6" from end.

LOCKING HUTCH DOORS

Locking doors are available on hutches.

Please specify with locking and add \$71 list to the following units.

- 21-1672HU
- 21-1666HU

Please specify with locking and add \$58 list to the following units.

- 21-1636WD

Item	Model No.	W	D	H	K	R	Ship Wt	Cubic Ft	List Price
EXECUTIVE DOUBLE PED DESK BOW TOP	21-3672BDP	72	36-30	30	38 3/4	10 3/4	360	50.0	P \$ 2981
									W \$ 3179

Description

- Bow Top
- Stepped Front
- Locking Pedestals
- Box/Box/File in Left Pedestal
- File/File in Right Pedestal
- Wire Management from Pedestal to Kneespace
- Black Utility Tray for Box Drawer

EXECUTIVE DOUBLE PED DESK RECTANGULAR TOP	21-3672DP	72	36	30	38 3/4	10 3/4	274	50.0	P \$ 2747
									W \$ 2957

Description

- Stepped Front
- Locking Pedestals
- Box/Box/File in Left Pedestal
- File/File in Right Pedestal
- Wire Management from Pedestal to Kneespace
- Black Utility Tray for Box Drawer

EXECUTIVE DOUBLE PED DESK	21-3066DP	66	30	30	32 3/4	4 3/4	249	38.7	P \$ 2645
									W \$ 2882
	21-3060DP	60	30	30	26 3/4	4 3/4	241	35.3	P \$ 2591
									W \$ 2830

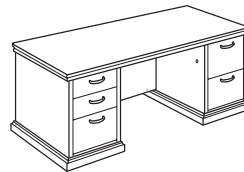
Description

- Stepped Front
- Locking Pedestals
- Box/Box/File in Left Pedestal
- File/File in Right Pedestal
- Wire Management from Pedestal to Kneespace
- Black Utility Tray for Box Drawer

TABLE DESK	21-3672TD	72	36	30	65 1/2	-	120	12.2	P \$ 1702
									W \$ 1915
	21-3066TD	66	30	30	59 1/2	-	110	9.7	P \$ 1599
									W \$ 1839

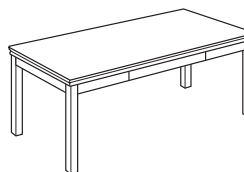
Description

- Center Drawer
- Top and Legs Ship Separately

21-0202TL	Table Legs						20	.1	Included
-----------	------------	--	--	--	--	--	----	----	----------

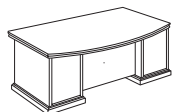

Approach View

For ordering options, see back of Phoenix Identification card card at the beginning of section.

For grommet options, see page 382.

For center drawer options, see page 394.

Item	Model No.	W	D	H	K	R	Ship Wt	Cubic Ft	List Price		
EXECUTIVE SINGLE PED DESK BOW TOP	Left Ped										
	Right Ped										
	21-3672BLP	21-3672BRP	72	36-30	30	31 3/8	10 3/4	320	50.0	P \$ 2505	W \$ 2699

Description

- Bow Top
- Stepped Front
- Locking Pedestal
- Box/Box/File in Pedestal
- Letter Width Pedestal
- Wire Management from Pedestal to Kneespace
- Black Utility Tray for Box Drawer

EXECUTIVE SINGLE PED DESK RECTANGULAR TOP	Left Ped										
	Right Ped										
	21-3672LP	21-3672RP	72	36	30	31 3/8	10 3/4	305	50.0	P \$ 2269	W \$ 2480
	21-3066LP	21-3066RP	66	30	30	25 3/8	4 3/4	221	38.7	P \$ 2163	W \$ 2401

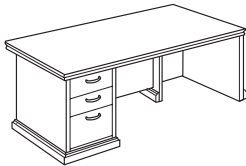
Description

- Stepped Front
- Locking Pedestals
- Box/Box/File in Pedestal
- Letter Width Pedestal
- Wire Management from Pedestal to Kneespace
- Black Utility Tray for Box Drawer

All pedestal desks shown as left.

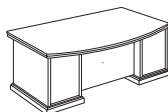

Approach View

For ordering options, see back of Phoenix Identification card card at the beginning of section.

For grommet options, see page 382.

For center drawer options, see page 394.

Item	Model No.	W	D	H	K	R	Ship Wt	Cubic Ft	List Price
P-TOP	Left Ped								
	21-4272PL	72	42-36	30	-	-	193	57.9	P \$ 2023 W \$ 2065

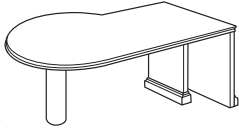

Description

- False Ped on Wing End
- Metal 4 1/2" Cylinder Base Standard. Must Specify: Black or Aluminum.
- Not Recommended for Freestanding Applications

Options: Specify & Add

21-FMD	Optional Full Modesty Panel	\$ 220
--------	-----------------------------	--------

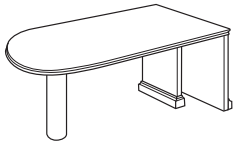
D-TOP	Left Ped	Right Ped	W	D	H	K	R	Ship Wt	Cubic Ft	List Price
D-TOP	21-3672DL	21-3672DR	72	36	30	-	-	221	50.0	P \$ 1697 W \$ 1905

Description

- False Ped on Wing End
- Metal 4 1/2" Cylinder Base Standard. Must Specify: Black or Aluminum.
- Not Recommended for Freestanding Applications

Options: Specify & Add

21-FMD	Optional Full Modesty Panel	\$ 220
--------	-----------------------------	--------

All pedestal desks shown as left.

For ordering options, see back of Phoenix Identification card card at the beginning of section.

For grommet options, see page 382.

For center drawer options, see page 394.

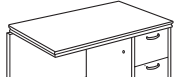
Item	Model No.	W	D	H	K	R	Ship Wt	Cubic Ft	List Price	
EXECUTIVE RETURN FILE/FILE 	Left Ped	Right Ped								
	21-2448LF2	21-2448RF2	48	24	30	31 3/8	-	151	23.1	P \$ 1633 W \$ 1767
	21-2442LF2	21-2442RF2	42	24	30	25 3/8	-	133	20.4	P \$ 1604 W \$ 1717

Description

- Locking Pedestals
- File/File in Pedestal
- Letter Width Pedestal
- Grommet in Back Panel
- Wire Management from Pedestal to Kneespace
- Grain Direction Runs Front to Back on Worksurface

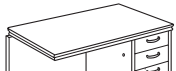
Item	Model No.	W	D	H	K	R	Ship Wt	Cubic Ft	List Price	
EXECUTIVE RETURN BOX/BOX/FILE 	Left Ped	Right Ped								
	21-2448LF1	21-2448RF1	48	24	30	31 3/8	-	140	23.1	P \$ 1633 W \$ 1767
	21-2442LF1	21-2442RF1	42	24	30	25 3/8	-	133	20.4	P \$ 1604 W \$ 1717

Description

- Locking Pedestals
- Box/Box/File in Pedestal
- Letter Width Pedestal
- Grommet in Back Panel
- Wire Management from Pedestal to Kneespace
- Grain Direction Runs Front to Back on Worksurface

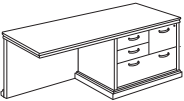
Item	Model No.	W	D	H	K	R	Ship Wt	Cubic Ft	List Price	
EXECUTIVE RETURN MULTI-FILE PEDESTAL BOX/BOX/FILE/LATERAL 	Left Ped	Right Ped								
	21-2472LMR	21-2472RMR	72	24	30	36	-	280	33.6	P \$ 2300 W \$ 2546

Description

- Locking File Drawers Only
- Box/Box/File Over Lateral File
- Lateral File Provides Legal or Letter Filing Side to Side or Front to Back
- Grommet in Back Panel
- Grain Direction Runs Front to Back on Veneer Worksurfaces, Laminate Worksurfaces
Run Left to Right

All returns shown as right.

For ordering options, see back of Phoenix Identification card card at the beginning of section.

For grommet options, see page 382.

For center drawer options, see page 394.

Item	Model No.	W	D	H	K	R	Ship Wt	Cubic Ft	List Price
EXECUTIVE BRIDGE FULL MODESTY	21-2448UF	48	24	30	48	-	82	5.3	P \$ 963 W \$ 1019
	21-2442UF	42	24	30	42	-	68	4.7	P \$ 927 W \$ 978

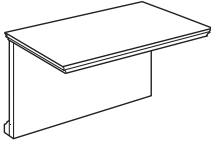
Description

- Grommet in Back Panel
- Grain Direction Runs Front to Back on Worksurface
- Hinged Back Panel

NOTE: Keyboards cannot be factory installed.

EXECUTIVE BRIDGE HALF MODESTY	21-2448UFH	48	24	11 ⁵ / ₃₂	48	-	54	5.3	P \$ 892 W \$ 951
	21-2442UFH	42	24	11 ⁵ / ₃₂	42	-	43	4.7	P \$ 862 W \$ 912

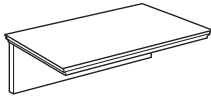
Description

- Grain Direction Runs Front to Back on Worksurface
- Hinged Modesty Panel

NOTE: Keyboards cannot be factory installed.

CORNER UNIT	21-4242CU	42	42	30	25 ⁷ / ₁₆	-	145	34.5	P \$ 1495 W \$ 1604
	21-3636CU	36	36	30	17	-	135	25.7	P \$ 1335 W \$ 1420

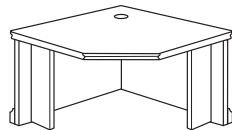
Description

- Connects to 24" Deep Bridge and Return Units
- Grommet in Top
- Freestanding Support Unit
- Grain Direction Runs Front to Back on Veneer Worksurfaces
- Grain Direction Runs with the Long Edge on HPL Worksurfaces

NOTE: Not all keyboards will fit the 21-3636CU. Recommended keyboards are 1-KCWR, 1-KCPR, and 1-KC.

For ordering options, see back of Phoenix Identification card card at the beginning of section.

For grommet options, see page 382.

For center drawer options, see page 394.

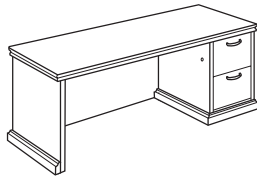
Item	Model No.	W	D	H	K	R	Ship Wt	Cubic Ft	List Price	
EXECUTIVE CREDENZA FILE/FILE 	Left Ped	Right Ped								
	21-2072LC2	21-2072RC2	72	20 7/16	30	31 3/8	-	235	29.0	P \$ 1874 W \$ 2116
	21-2066LC2	21-2066RC2	66	20 7/16	30	25 3/8	-	225	26.6	P \$ 1803 W \$ 2046

Description

- Locking Pedestal
- File/File in Letter Width Pedestal
- Grommet in Back Panel
- Profiled on 3 Sides for Flush Wall Applications

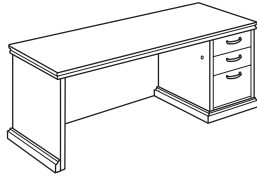
Item	Model No.	W	D	H	K	R	Ship Wt	Cubic Ft	List Price	
EXECUTIVE CREDENZA BOX/BOX/FILE 	Left Ped	Right Ped								
	21-2072LC1	21-2072RC1	72	20 7/16	30	31 3/8	-	235	29.0	P \$ 1874 W \$ 2116
	21-2066LC1	21-2066RC1	66	20 7/16	30	25 3/8	-	225	26.6	P \$ 1803 W \$ 2046

Description

- Locking Pedestal
- Box/Box/File in Letter Width Pedestal
- Grommet in Back Panel
- Profiled on 3 Sides for Flush Wall Applications

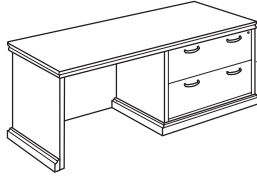
Item	Model No.	W	D	H	K	R	Ship Wt	Cubic Ft	List Price	
EXECUTIVE CREDENZA LATERAL/LATERAL 	Left Ped	Right Ped								
	21-2072LL	21-2072RL	72	20 7/16	30	12	-	255	29.0	P \$ 2043 W \$ 2285
	21-2066LL	21-2066RL	66	20 7/16	30	6	-	220	26.6	P \$ 1918 W \$ 2161

Description

- Central Locking
- Lateral/Lateral in Pedestal Provide Legal or Letter Filing Front to Back or Side to Side
- Grommet in Back Panel
- Profiled on 3 Sides for Flush Wall Applications

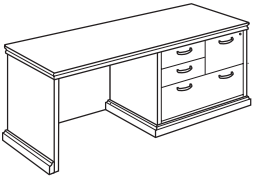
Item	Model No.	W	D	H	K	R	Ship Wt	Cubic Ft	List Price	
EXECUTIVE CREDENZA BOX/BOX/FILE/LATERAL 	Left Ped	Right Ped								
	21-2072LMF	21-2072RMF	72	20 7/16	30	12	-	255	29.0	P \$ 2275 W \$ 2517
	21-2066LMF	21-2066RMF	66	20 7/16	30	6	-	220	26.6	P \$ 2209 W \$ 2452

Description

- Locking File Drawers Only
- Box/Box/File/Lateral in Pedestal
- Grommet in Back Panel
- Profiled on 3 Sides for Flush Wall Applications

All credenzas shown as right.

For ordering options, see back of Phoenix Identification card card at the beginning of section.

For grommet options, see page 382.

For center drawer options, see page 394.

Item	Model No.	W	D	H	K	R	Ship Wt	Cubic Ft	List Price
TRANSACTION RISER FOR DESKS/CREDENZAS	21-1272TR	72	12	13 5/32	-	-	60	9.0	P \$ 997 W \$ 1035
	21-1266TR	66	12	13 5/32	-	-	55	7.5	P \$ 928 W \$ 1017

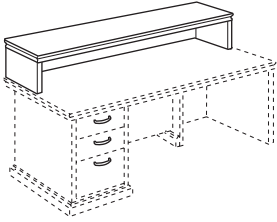
Description

- Freestanding Riser for Desks or Credenzas
- May Be Used in Conjunction with Return Risers or Bridge Risers

TRANSACTION RISER FOR RETURNS	Left Ped	Right Ped	W	D	H	K	R	Ship Wt	Cubic Ft	List Price
	21-0972LU For Use with 36" Desks and 48" Returns	21-0972RU	72	9	13 5/32	-	-	45	8.2	P \$ 882 W \$ 949
21-0966LU For Use with 30" Desks and 48" Returns	21-0966RU	66	9	13 5/32	-	-	49	7.5	P \$ 860 W \$ 918	

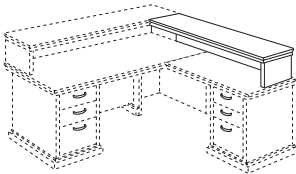
Description

- Must Be Used in Conjunction with a Desk Riser
- Grain Direction Runs Left to Right on Worksurface if Laminate Top is Specified

TRANSACTION RISER FOR BRIDGES	21-0980BU For Use with 36" Desk and 48" Bridge	80 7/16	9	13 5/32	-	-	66	8.8	P \$ 897 W \$ 948
	21-0968BU For Use with 30" Desk and 42" Bridge	68 7/16	9	13 5/32	-	-	60	8.4	P \$ 847 W \$ 898

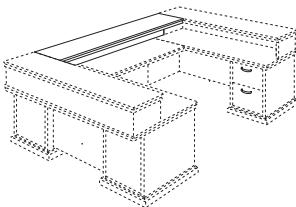
Description

- Must Be Used in Conjunction with Two Desk/Credenza Risers
- Grain Direction Runs Left to Right on Worksurface if Laminate Top is Specified

For ordering options, see back of Phoenix Identification card card at the beginning of section.

Item	Model No.	W	D	H	K	R	Ship Wt	Cubic Ft	List Price
STORAGE CREDENZA FULL PEDESTAL	21-2072SC	72	20 ⁷ / ₁₆	30	-	-	349	29.0	P \$ 2731 W \$ 2975
	21-2066SC	66	20 ⁷ / ₁₆	30	-	-	320	26.6	P \$ 2634 W \$ 2874

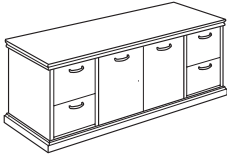
Description

- Pedestals Lock Behind Doors
- File/File in Both Pedestals
- Fixed Storage Shelf Behind Doors
- Profiled on 3 Sides for Flush Wall Applications

KNEESPACE CREDENZA FULL PEDESTAL	21-2072KC	72	20 ⁷ / ₁₆	30	38 ³ / ₄	-	300	29.0	P \$ 2355 W \$ 2597
	21-2066KC	66	20 ⁷ / ₁₆	30	32 ³ / ₄	-	285	26.6	P \$ 2279 W \$ 2519

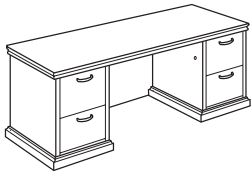
Description

- Locking Pedestals
- File/File in Both Pedestals
- Grommet in Back Panel
- Profiled on 3 Sides for Flush Wall Applications

For ordering options, see back of Phoenix Identification card card at the beginning of section.

For grommet options, see page 382.

Item	Model No.	W	D	H	K	R	Ship Wt	Cubic Ft	List Price	
FOUR DRAWER LATERAL FILE	21-2036L4	36	20 7/16	55	-	-	260	27.5	P \$	2615
									W \$	2752

Description

- Central Locking
- Anti-Tilt Mechanism
- File Drawers Provide Legal or Letter Filing Front to Back or Side to Side
- 1/4" Thick Drawer Bottoms Allow for Storage Applications
- Profiled on 3 Sides for Flush Wall Applications

TWO DRAWER LATERAL FILE	21-2036L2	36	20 7/16	30	-	-	185	14.9	P \$	1755
									W \$	1889

Description

- Central Locking
- Anti-Tilt Mechanism
- File Drawers Provide Legal or Letter Filing Front to Back or Side to Side
- 1/4" Thick Drawer Bottoms Allow for Storage Applications
- Profiled on 3 Sides for Flush Wall Applications

For ordering options, see back of Phoenix Identification card card at the beginning of section.

Item	Model No.	W	D	H	K	R	Ship Wt	Cubic Ft	List Price
TOP UNIT BOOKCASE	21-1636TU	36	15 3/4	38 11/32	-	-	125	15.8	\$ 1126

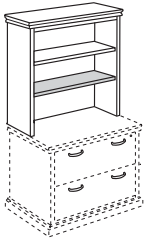
Description

- Fixed Bottom Shelf with 12" Clearance
- One Adjustable Shelf
- For Use on Two Drawer Lateral Files
- Profiled on 3 Sides for Flush Wall Applications
- 1" Thick Shelves

HUTCH	21-1672HU	72	15 3/4	38 11/32	-	-	258	30.7	\$ 1917
	21-1666HU	66	15 3/4	38 11/32	-	-	235	28.1	\$ 1890

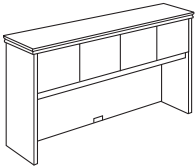
Description

- Grommet
- Profiled on 3 Sides for Flush Wall Applications
- 20 5/16" Clearance Below Doors

WOOD DOOR WALL MOUNT HUTCH	21-1636WD	36	15 3/4	17 15/32	-	-	60	6.7	\$ 1416
-------------------------------	-----------	----	--------	----------	---	---	----	-----	---------

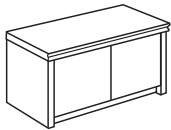

Description

- Mounts to Wall with Mounting Bracket Included

NOTE: Indiana Furniture will not be liable for wall mount hutch units that are not properly installed.

For ordering options, see back of Phoenix Identification card card at the beginning of section.

For tackboard and tasklights, see page 398.

Item	Model No.	W	D	H	K	R	Ship Wt	Cubic Ft	List Price
BOOKCASES 	21-3668BC Three Adjustable Shelves - Unfinished Back	36	15 3/4	67 19/32	-	-	165	24.3	\$ 1728
	21-3648BC Two Adjustable Shelves - Finished Back	36	15 3/4	48 3/32	-	-	104	19.9	P \$ 1296 W \$ 1363
	21-3630BC One Adjustable Shelf - Finished Back	36	15 3/4	30	-	-	85	11.1	P \$ 1166 W \$ 1233

Description

- 1" Thick Shelves
- Profiled on 3 Sides for Flush Wall Applications

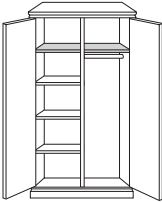
DOUBLE WARDROBE/STORAGE 	21-3668WD Unfinished Back	36	20 7/16	67 19/32	-	-	290	42.0	\$ 2592
---	------------------------------	----	---------	----------	---	---	-----	------	---------

Description

- Fixed Top Shelf Behind Each Door
- Coat Rod Under Fixed Shelf on Right Side
- Three Adjustable Shelves on Left Side
- Profiled on 3 Sides for Flush Wall Applications
- Recommended Against Wall

For ordering options, see back of Phoenix Identification card card at the beginning of section.

Item	Model No.	W	D	H	K	R	Ship Wt	Cubic Ft	List Price
COMPUTER WORK TABLE	21-2436CW	36	24	27	32 ³ / ₁₆	-	110	17.6	P \$ 1005 W \$ 1079

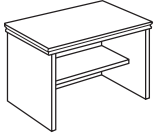

Description

- Fixed Shelf
- Grommet in Back Panel

Options: Specify & Add

CS-20BL	Optional Black Casters	\$	150
---------	------------------------	----	-----

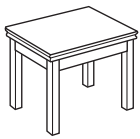
END TABLE	21-1824ET	18	24	22	-	-	25	2.0	P \$ 581 W \$ 613
-----------	-----------	----	----	----	---	---	----	-----	----------------------

Description

- Shipped KD - Some Assembly Required

MAGAZINE TABLE	21-1847MT	47	18	16	-	-	42	3.4	P \$ 757 W \$ 827
----------------	-----------	----	----	----	---	---	----	-----	----------------------

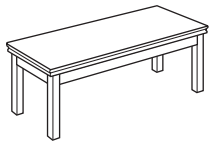

Description

- Shipped KD - Some Assembly Required

Options: Specify & Add

SH-20	Optional 30" H Legs	20	.9	\$	147
-------	---------------------	----	----	----	-----

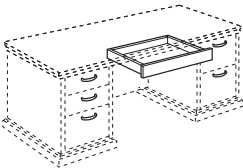
CENTER DRAWER	21-1622CD	22	16 ³ / ₄	2 ³ / ₄	-	-	7	1.4	\$ 293
---------------	-----------	----	--------------------------------	-------------------------------	---	---	---	-----	--------



Description

- Fits All Desks
- Built in Pen Tray

Options: Specify & Add

Factory Installed	\$	130
-------------------	----	-----

For ordering options, see back of Phoenix Identification card card at the beginning of section.

Item	Model No.	W	D	H	K	R	Ship Wt	Cubic Ft	List Price
CIRCULAR TOP 	21-4848CT Accommodates 5 Chairs	48	48	1 ⁵ / ₃₂	-	-	63	5.7	P \$ 993 W \$ 1283
	21-4242CT Accommodates 4 Chairs	42	42	1 ⁵ / ₃₂	-	-	40	4.4	P \$ 922 W \$ 1183
	21-3636CT Accommodates 3 Chairs	36	36	1 ⁵ / ₃₂	-	-	35	3.4	P \$ 854 W \$ 1087

Description

- One Base Required

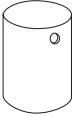
Item	Model No.	W	D	H	K	R	Ship Wt	Cubic Ft	List Price
CYLINDER BASE 	01-2020CB For Use with 48" or 42" Circular Tops	20	20	28 ¹ / ₄	-	-	134	11.1	\$ 977
	01-1616CB For Use with 36" Circular Top	16	16	28 ¹ / ₄	-	-	101	7.2	\$ 892

Description

- Veneer Cylinder Base
- Weighted for Stability
- Wire Management in Bottom
- 2 Wire Management Grommets Standard at Top with 8" Opening Standard in Bottom

Options: Specify & Add

GCB1S	Optional Grommet Top Edge (1)	\$	N/C
NOGC	Optional No Grommets At Top Edges	\$	N/C

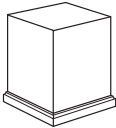
Item	Model No.	W	D	H	K	R	Ship Wt	Cubic Ft	List Price
SQUARE TABLE BASE 	21-2020SB For Use with 48" or 42" Circular Tops	20	20	28 ¹ / ₄	-	-	57	8.4	\$ 741
	21-1616SB For Use with 36" Circular Top	16	16	28 ¹ / ₄	-	-	41	6.0	\$ 688

Description

- Veneer Base
- Wire Management in Bottom
- 2 Wire Management Grommets Standard at Top with 8" Opening Standard in Bottom

For ordering options, see back of Phoenix Identification card card at the beginning of section.

Item	Model No.	W	D	H	K	R	Ship Wt	Cubic Ft	List Price
EXECUTIVE "L" UNIT	21-1	72	84	30	31 3/8	10 3/4	372	73.1	P \$ 3902 W \$ 4247

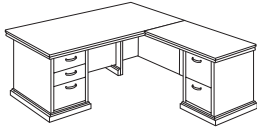
Consists of:
Qty

21-3672LP	1	• Left Pedestal Desk	P \$ 2269 W \$ 2480
21-2448RF2	1	• Executive Right Return	P \$ 1633 W \$ 1767

EXECUTIVE "U" UNIT BOW TOP DESK STEPPED FRONT	21-2	72	104 7/16	30	31 3/8	10 3/4	568	85.5	P \$ 5342 W \$ 5834
---	------	----	----------	----	--------	--------	-----	------	------------------------

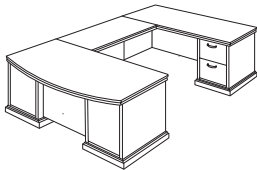
Consists of:
Qty

21-3672BLP	1	• Bow Left Pedestal Desk	P \$ 2505 W \$ 2699
21-2448UF	1	• Bridge	P \$ 963 W \$ 1019
21-2072RC2	1	• Executive Single Right Credenza	P \$ 1874 W \$ 2116

All pedestal desks shown as left.
 All returns shown as right.

For ordering options, see back of Phoenix Identification card card at the beginning of section.

For standard options, see page 382.

Item	Model No.	W	D	H	K	R	Ship Wt	Cubic Ft	List Price
EXECUTIVE "U" UNIT P-TOP	21-3	72	110 ⁷ / ₁₆	30	-	-	409	95.3	P \$ 4860 W \$ 5200

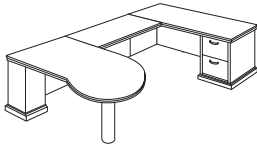
Consists of:
Qty

21-4272PL	1	• Left P Top Unit	P \$ 2023 W \$ 2065
21-2448UF	1	• Bridge	P \$ 963 W \$ 1019
21-2072RC2	1	• Executive Single Right Credenza	P \$ 1874 W \$ 2116

EXECUTIVE "U" UNIT D-TOP	21-4	72	104 ⁷ / ₁₆	30	-	-	408	85.5	P \$ 4534 W \$ 5040
-----------------------------	------	----	----------------------------------	----	---	---	-----	------	------------------------

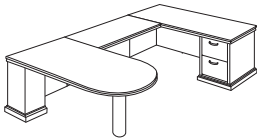
Consists of:
Qty

21-3672DL	1	• Peninsula D Top Unit	P \$ 1697 W \$ 1905
21-2448UF	1	• Bridge	P \$ 963 W \$ 1019
21-2072RC2	1	• Executive Single Right Credenza	P \$ 1874 W \$ 2116

All layouts shown as right U-groups.

For ordering options, see back of Phoenix Identification card card at the beginning of section.

For standard options, see page 382.

TACKBOARD: SURFACE MOUNTED HUTCHES – 20 1/8" TALL

Size	Model #	COM ydg	COM, Grade 1, 2 or 3 List Price	Grade 4 List Price	Grade 5 List Price	Grade 6 List Price	Grade 7 List Price	Grade 8 List Price	Grade 9 List Price	Grade 10 List Price
66"	TB-2066H	2.00	\$ 336	\$ 518	\$ 600	\$ 690	\$ 810	\$ 937	\$ 1090	\$ 1263
72"	TB-2072H	2.25	\$ 357	\$ 561	\$ 653	\$ 755	\$ 890	\$ 1033	\$ 1204	\$ 1399

TACKBOARD: WALL MOUNTED HUTCHES – 21 7/8" TALL

Size	Model #	COM ydg	COM, Grade 1, 2 or 3 List Price	Grade 4 List Price	Grade 5 List Price	Grade 6 List Price	Grade 7 List Price	Grade 8 List Price	Grade 9 List Price	Grade 10 List Price
36"	TB-0136W	1.25	\$ 274	\$ 387	\$ 438	\$ 495	\$ 570	\$ 649	\$ 744	\$ 853

TASKLIGHTS – Includes 1 Wire Management Grommet

Model #	Size	Description	List Price
TL-0824	22 1/2" x 1 5/8" x 7/8"	84-LED, 7 Watts	\$ 234
TL-0848	47 1/2" x 1 5/8" x 7/8"	240-LED, 18 Watts	\$ 280

ArlingtonTM

Casegoods Collection

How to Order

MODEL NO.	DESCRIPTION
29-3672DP	Finish MW Pull ARA

All options must be labeled and specified.



Specifications

veneer

Veneers on exposed surfaces are select grade sliced American Black Walnut and are carefully selected and matched to assure proper balance and consistency.

tops

High pressure laminate tops are 3-ply balanced construction, 1½" thick with solid hardwood rims. Grain direction runs left to right unless otherwise noted.

chassis construction

Pedestals are of mortised and tenoned construction with all joints securely fastened with screws, hardwood screw rail brackets, and glue blocks. Solid hardwood parting rails assure a sturdy pedestal. Bases are solid hardwood with mitered corners. Superior construction offers tight tolerances and long term durability. All units equipped with heavy-duty adjustable glides to ensure proper leveling and compensate for uneven floors.

drawers

All drawer fronts are standard with elegant walnut bookmatched veneer faces. Fronts are 3-ply construction and ¾" thick. Drawer sides and backs are constructed with ¾" thick oak-grained medium density fiberboard. Drawers are constructed with ½" thick oak-grained hardboard bottoms. Lateral files have ¼" thick bottoms for storage applications. Drawers are assembled to assure maximum strength and durability.

drawer suspension

File drawers have high quality, progressive full extension slides with precision steel ball bearings to ensure a smooth, quiet operation. Tray and box drawers are equipped with ¾" extension ball bearing roller suspensions. All suspensions have a lifetime warranty.

filing hardware

All file drawers are standard with custom fitted filing systems designed to accommodate a variety of filing requirements. Legal width file drawers provide legal filing front to back, and letter or legal filing side to side. Letter width file drawers provide letter filing front to back, and letter or legal filing side to side.

locking

Central locking is standard on all desks. One key in the lock cylinder locks all drawers in the desk. Removable lock cylinders allow for units to be re-keyed at a later date if required. Units are shipped randomly keyed as standard.

cord management

Route power and data cables away from the worksurface through inherent grommet placement. Black grommets are standard in back panels of assembled returns, bridge units, kneespace credenzas, and hutch units. A grommet is standard in tops of corner units. Grommets may be ordered in the tops of desks, returns, bridge units, credenzas, and component work-surfaces. See page 404 for all optional grommet locations.

Undersurface tracks are available for additional cord management. Silver grommets are also available. See Accessories.

finish

The multi-step, finish process used by Indiana Furniture provides years of lasting beauty. High quality finish materials offer distinctive grain clarity, superior resistance to normal wear, and ease of maintenance.

Finish Options



Legacy Walnut
LW



Harvest Walnut
HW



Mahogany on Walnut
MW

Edge Options



Arlington
R

All units are standard with a traditional edge detail.

Pull Options



Arlington A
ARA

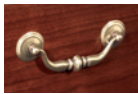

Arlington B
ARB

COORDINATING PRODUCTS

Arlington Casegoods offers options to coordinate with Cameo Conference and Cameo Reception.

INTERIOR DRAWER DIMENSIONS

ARLINGTON 2900 INTERIOR DRAWER DIMENSIONS

Item	Drawers	W	L	D
29-3672DP	Tray	12 ³ / ₈	19 ⁹ / ₃₂	1 ²⁹ / ₃₂
29-3066DP	File	12 ³ / ₈	19 ⁹ / ₃₂	8 ²⁹ / ₃₂
	Box	12 ³ / ₈	19 ⁹ / ₃₂	3 ²¹ / ₃₂
	Center	29 ⁵ / ₈	19 ⁹ / ₃₂	1 ²⁹ / ₃₂
29-3672LP	Tray	12 ³ / ₈	19 ⁹ / ₃₂	1 ²⁹ / ₃₂
29-3672RP	File	12 ³ / ₈	19 ⁹ / ₃₂	8 ²⁹ / ₃₂
	Box	12 ³ / ₈	19 ⁹ / ₃₂	3 ²¹ / ₃₂
	Center	27 ⁵ / ₈	19 ⁹ / ₃₂	1 ²⁹ / ₃₂
29-3066LP	Tray	12 ³ / ₈	19 ⁹ / ₃₂	1 ²⁹ / ₃₂
29-3066RP	File	12 ³ / ₈	19 ⁹ / ₃₂	8 ²⁹ / ₃₂
	Box	12 ³ / ₈	19 ⁹ / ₃₂	3 ²¹ / ₃₂
	Center	21 ⁵ / ₈	19 ⁹ / ₃₂	1 ²⁹ / ₃₂
29-3060DP	Tray	12 ³ / ₈	19 ⁹ / ₃₂	1 ²⁹ / ₃₂
	File	12 ³ / ₈	19 ⁹ / ₃₂	8 ²⁹ / ₃₂
	Box	12 ³ / ₈	19 ⁹ / ₃₂	3 ²¹ / ₃₂
	Center	23 ⁵ / ₈	19 ⁹ / ₃₂	1 ²⁹ / ₃₂
29-3060LP	Tray	12 ³ / ₈	19 ⁹ / ₃₂	1 ²⁹ / ₃₂
29-3060RP	File	12 ³ / ₈	19 ⁹ / ₃₂	8 ²⁹ / ₃₂
	Box	12 ³ / ₈	19 ⁹ / ₃₂	3 ²¹ / ₃₂
	Center	18 ⁵ / ₈	19 ⁹ / ₃₂	1 ²⁹ / ₃₂
29-2142LF	Tray	12 ³ / ₈	16 ⁵ / ₃₂	1 ²⁹ / ₃₂
29-2142RF	File	12 ³ / ₈	16 ⁵ / ₃₂	8 ²⁹ / ₃₂
29-2445LF	Box	12 ³ / ₈	16 ⁵ / ₃₂	3 ²¹ / ₃₂
29-2445RF				
29-2142LR	Box	12 ³ / ₈	16 ⁵ / ₃₂	8 ²⁹ / ₃₂
29-2142RR	File	12 ³ / ₈	16 ⁵ / ₃₂	3 ²¹ / ₃₂
29-2445LR				
29-2445RR				
29-2072SC	Tray	15 ³ / ₈	16 ⁵ / ₃₂	1 ²⁹ / ₃₂
29-2072KC	File	15 ³ / ₈	16 ⁵ / ₃₂	8 ²⁹ / ₃₂
29-2072LC	Box	15 ³ / ₈	16 ⁵ / ₃₂	3 ²¹ / ₃₂
29-2072RC				
29-2066SC	Tray	12 ³ / ₈	16 ⁵ / ₃₂	1 ²⁹ / ₃₂
29-2066KC	File	12 ³ / ₈	16 ⁵ / ₃₂	8 ²⁹ / ₃₂
29-2066LC	Box	12 ³ / ₈	16 ⁵ / ₃₂	3 ²¹ / ₃₂
29-2066RC				
29-2030L2	File	24 ⁷ / ₈	16 ⁹ / ₃₂	9 ¹⁷ / ₃₂
29-2060DL				
29-2072LL				
29-2072RL				
29-2036L4	File	30 ³ / ₄	16 ⁵ / ₃₂	8 ¹³ / ₃₂
29-2036L2				
29-3672TD	Tray	21 ⁵ / ₈	19 ⁹ / ₃₂	1 ²⁹ / ₃₂
29-3066TD				
29-2648LP	Tray	12 ³ / ₈	19 ⁹ / ₃₂	1 ²⁹ / ₃₂
29-2648RP	File	12 ³ / ₈	19 ⁹ / ₃₂	8 ²⁹ / ₃₂
	Box	12 ³ / ₈	19 ⁹ / ₃₂	3 ²¹ / ₃₂

FILING CAPABILITIES

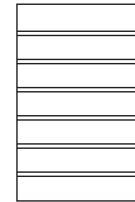
 12 ³/₈ x 19 ⁹/₃₂

Letter Front to Back

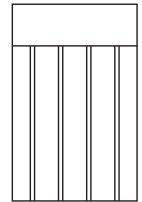

Legal Side to Side

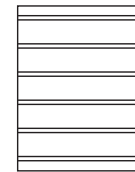
 12 ³/₈ x 16 ⁵/₃₂

Letter Front to Back

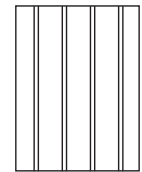

Legal Side to Side

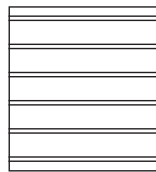
 15 ³/₈ x 16 ⁵/₃₂

Legal Front to Back

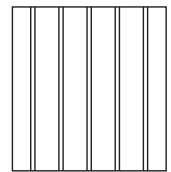

Legal Side to Side

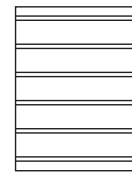
 12 ³/₈ x 16 ⁵/₃₂

Letter Front to Back

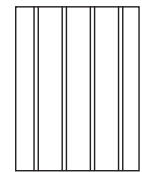

Legal Side to Side

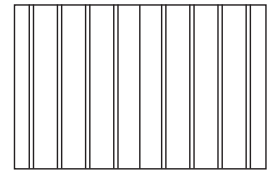
 24 ⁷/₈ x 16 ⁹/₃₂

1 Row Letter or Legal Side to Side

 30 ³/₄ x 16 ⁵/₃₂

2 Rows Letter Front to Back

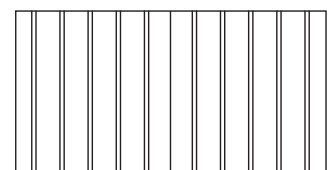

1 Row Letter or Legal Side to Side

GROMMET LOCATIONS

Add upcharge of \$48 list for each grommet.

Specify grommet locations.

- GL - Grommet Left
- GC - Grommet Center
- GR - Grommet Right

Example: 29-3066LP-GR (Grommet Right)

Grommets may be ordered in non-standard locations. Please call Customer Service to assist with how to order and additional lead time requirements.

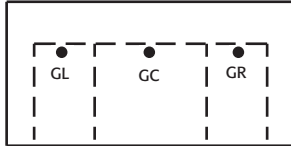

29-3672DP
 29-3672LP
 29-3672RP

GL/GR - 12" from ends, 23" from user side.
 GC - 23" from user side.

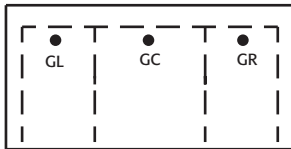

29-3066DP
 29-3066LP
 29-3066RP

GL/GR - 9" from ends, 23" from user side.
 GC - 23" from user side.

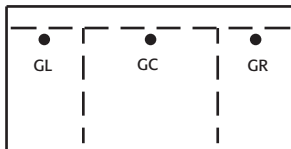

29-3060DP
 29-3060LP
 29-3060RP

GL/GR - 9" from ends, 23" from user side.
 GC - 23" from user side.

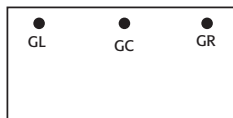

29-2450UF
 29-2450UFH
 29-2442UF
 29-2442UFH

GL/GR - 4" from ends, 19 1/2" from user side.
 GC - 19 1/2" from user side.

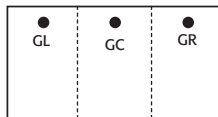

29-2445LR
 29-2445RR
 29-2445LF
 29-2445RF

GL/GR - 5" from ends, 20" from user side.
 GC - 20" from user side.

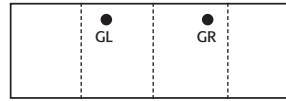
GROMMET LOCATIONS - CONTINUED

29-2072KC
 29-2072LC
 29-2072RC
 29-2072LL
 29-2072RL

GL/GR - 22 1/2" from ends, 17 3/8" from user side.



29-2066KC
 29-2066LC
 29-2066RC

GL/GR - 19 1/2" from ends, 17 3/8" from user side.

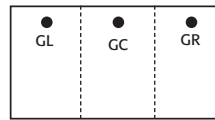

29-2142RR
 29-2142LR
 29-2142RL
 29-2142RF

GL/GR - 5" from ends, 17" from user side.
 GC - 17" from user side.

LOCKING FILE DRAWERS

Locking file drawers are available on returns and credenzas.

Returns and single pedestal credenzas have optional locking file drawers with the lock positioned in the upper right corner of the file drawer. Upcharge for return or single pedestal credenza locking file drawer is \$127 list.

Double pedestal credenzas have optional locking in both file drawers with the lock positioned in the upper right corner of both file drawers. Upcharge for locking double pedestal credenzas is \$252 list.

LOCKING HUTCH DOORS

Locking doors are available on hutches. Please specify with locking and add \$71 list to the following units.

29-1572HU 29-1566HU
 29-1572AH 29-1566AH

Please specify with locking and add \$58 list to the following units.

29-1536WD 29-1536AW

HARDWOOD DRAWER INTERIORS

Hardwood drawer interiors may be ordered on all units. Please add 5% per unit with drawers. Clearly mark the order when choosing this option.

Item	Model No.	W	D	H	K	R	Ship Wt	Cubic Ft	List Price
EXECUTIVE DOUBLE PED DESK	29-3672DP Chassis 64W x 24D	72	36	30	31 1/2	-	266	51.7	\$ 2511

Description

- Central Locking
- Letter Width Pedestals
- Tray/File/Box Pedestals
- Pull Out Writing Shelves

EXECUTIVE DOUBLE PED DESK	29-3066DP Chassis 64W x 24D	66	30	30	31 1/2	-	249	40.3	\$ 2471
	29-3060DP Chassis 58W x 24D	60	30	30	25 1/2	-	241	35.3	\$ 2362

Description

- Central Locking
- Letter Width Pedestals
- Tray/File/Box Pedestals
- Pull Out Writing Shelves

TABLE DESK	29-3672TD	72	36	30	-	-	120	12.2	\$ 1926
	29-3066TD	66	30	30	-	-	110	9.7	\$ 1698

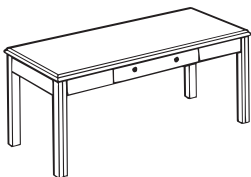
Description

- Center Drawer
- Top and Legs Ship Separately

Options: Specify & Add

29-0202TL	Standard Straight Legs	3.12	Included
29-0202QL	Optional Queen Anne Legs	3.12	\$ 1469

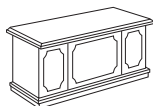

Approach View

For ordering options, see back of Arlington Identification card at the beginning of section.

For grommet options, see page 404.

Item	Model No.	W	D	H	K	R	Ship Wt	Cubic Ft	List Price	
EXECUTIVE SINGLE PED DESK	Left Ped	Right Ped								
	29-3672LP Chassis 70W x 24D	29-3672RP	72	36	30	30 3/4	-	221	51.7	\$ 2471

Description

- Central Locking
- Letter Width Pedestal
- Tray/File/Box in Pedestal
- Pull Out Writing Shelf

Item	Model No.	W	D	H	K	R	Ship Wt	Cubic Ft	List Price	
EXECUTIVE SINGLE PED DESK	Left Ped	Right Ped								
	29-3066LP Chassis 64W x 24D	29-3066RP	66	30	30	24 3/4	-	189	40.3	\$ 2158
	29-3060LP Chassis 58W x 24D	29-3060RP	60	30	30	18 3/4	-	186	35.3	\$ 2000

Description

- Central Locking
- Letter Width Pedestal
- Tray/File/Box in Pedestal
- Pull Out Writing Shelf

All pedestal desks shown as left.

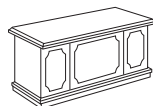

Approach View

For ordering options, see back of Arlington Identification card at the beginning of section.

For grommet options, see page 404.

Item	Model No.	W	D	H	K	R	Ship Wt	Cubic Ft	List Price	
EXECUTIVE RETURN TRAY/FILE/BOX	Left Ped	Right Ped								
	29-2445LF	29-2445RF	45	24	30	26 1/4	-	125	22.9	\$ 1789
	For Use with 66" and 72" Desks									
	29-2142LF	29-2142RF	42	21	30	23 1/4	-	113	18.8	\$ 1551
	For Use with 60" Desks									

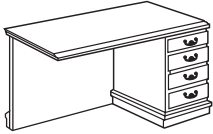
Description

- Letter Width Pedestal
- Tray/File/Box in Pedestal
- Grommet in Back Panel
- Grain Direction Runs Front to Back on Worksurface

Item	Model No.	W	D	H	K	R	Ship Wt	Cubic Ft	List Price	
OPERATIONAL RETURN BOX/FILE	Left Ped	Right Ped								
	29-2445LR	29-2445RR	45	24	27	27 3/4	-	123	19.6	\$ 1353
	For Use with 66" and 72" Desks									
	29-2142LR	29-2142RR	42	21	27	24 3/4	-	109	16.3	\$ 1305
	For Use with 60" Desks									

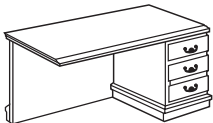
Description

- Letter Width Pedestal
- Box/File Pedestal
- Grain Direction Runs Front to Back on Worksurface

All returns shown as right.

For ordering options, see back of Arlington Identification card at the beginning of section.

For grommet options, see page 404.

Item	Model No.	W	D	H	K	R	Ship Wt	Cubic Ft	List Price
EXECUTIVE BRIDGE FULL MODESTY	29-2450UF	50	24	30	48 ⁷ / ₈	-	75	6.2	\$ 957
	29-2442UF	42	24	30	40 ⁷ / ₈	-	73	4.7	\$ 914

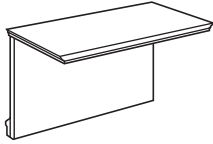
Description

- Grommet in Back Panel
- Grain Direction Runs Front to Back on Worksurface
- Hinged Modesty Panel

NOTE: Keyboards can not be factory installed.

EXECUTIVE BRIDGE HALF MODESTY	29-2450UFH	50	24	11 ¹ / ₁₆	48 ⁷ / ₈	-	63	6.2	\$ 845
	29-2442UFH	42	24	11 ¹ / ₁₆	40 ⁷ / ₈	-	59	4.7	\$ 806

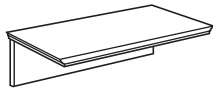
Description

- Grain Direction Runs Front to Back on Worksurface
- Hinged Modesty Panel

NOTE: Keyboards can not be factory installed.

CORNER UNIT	29-4242CU	42	42	30	25 ⁷ / ₁₆	-	137	34.5	\$ 1442
	29-3636CU	36	36	30	17	-	126	25.7	\$ 1305

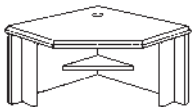

Description

- Freestanding Support Unit
- Connects to 24" Deep Bridge Units and Executive Height Returns
- Grommet in Top

NOTE: Not all keyboards will fit the 29-3636CU. Recommended keyboards are 1-KCWR, 1-KCPR, and 1-KC.

For ordering options, see back of Arlington Identification card at the beginning of section.

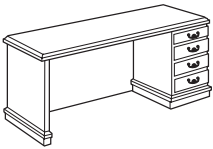
For grommet options, see page 404.

Item	Model No.	W	D	H	K	R	Ship Wt	Cubic Ft	List Price	
EXECUTIVE CREDENZA TRAY/FILE/BOX 	Left Ped	Right Ped								
	29-2072LC Legal Ped	29-2072RC	72	20 ⁷ / ₁₆	30	27 ³ / ₄	-	150	30.5	\$ 2137
	29-2066LC Letter Ped	29-2066RC	66	20 ⁷ / ₁₆	30	24 ³ / ₄	-	139	27.9	\$ 1892

Description

- Tray/File/Box in Pedestal
- Grommet in Back Panel
- Profiled on 3 Sides for Flush Wall Application

NOTE: Credenzas are recommended for application against a wall.

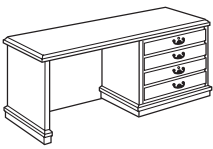
Item	Model No.	W	D	H	K	R	Ship Wt	Cubic Ft	List Price	
EXECUTIVE CREDENZA LATERAL/LATERAL 	Left Ped	Right Ped								
	29-2072LL	29-2072RL	72	20 ⁷ / ₁₆	30	18 ³ / ₁₆	-	182	30.5	\$ 2259

Description

- Locking File
- Legal or Letter Filing
- Grommet in Back Panel
- Profiled on 3 Sides for Flush Wall Application

NOTE: Credenzas are recommended for application against a wall.

All credenzas shown as right.

For ordering options, see back of Arlington Identification card at the beginning of section.

For grommet options, see page 404.

Item	Model No.	W	D	H	K	R	Ship Wt	Cubic Ft	List Price
TRANSACTION RISER FOR DESKS/CREDENZAS	29-1272TR For Use with 72" Worksurfaces	72	12	13 1/16	-	-	54	9.7	\$ 1436
	29-1266TR For Use with 66" Worksurfaces	66	12	13 1/16	-	-	51	9.5	\$ 1281

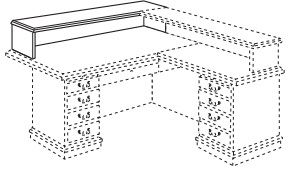
Description

- Freestanding Riser for Desks or Credenzas
- May Be Used in Conjunction with Return Risers or Bridge Risers

TRANSACTION RISER FOR RETURNS	Left Ped	Right Ped	W	D	H	K	R	Ship Wt	Cubic Ft	List Price
	29-0969LU For Use with 36" Desks and 45" Returns	29-0969RU	69	9	13 1/16	-	-	42	7.5	\$ 1368
29-0963LU For Use with 30" Desks and 45" Returns	29-0963RU	63	9	13 1/16	-	-	38	6.8	\$ 1225	

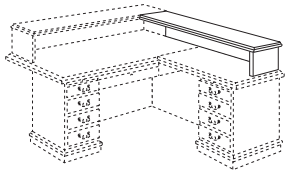
Description

- Must Be Used in Conjunction with a Desk Riser
- Grain Direction Runs Left to Right on Worksurface

TRANSACTION RISER FOR BRIDGES	29-0981BU For Use with 36" Desk, 50" Bridge, and Credenza	82 3/8	9	13 1/16	-	-	52	5.2	\$ 1318
	29-0968BU For Use with 30" Desk, 42" Bridge, and Credenza	68 3/8	9	13 1/16	-	-	41	6.9	\$ 1190

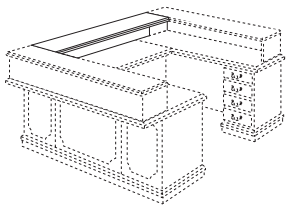
Description

- Must Be Used in Conjunction with Two Desk/Credenza Risers
- Grain Direction Runs Left to Right on Worksurface

For ordering options, see back of Arlington Identification card at the beginning of section.

Item	Model No.	W	D	H	K	R	Ship Wt	Cubic Ft	List Price
STORAGE CREDENZA FULL PEDESTAL	29-2072SC Legal Ped	72	20 ⁷ / ₁₆	30	-	-	234	30.5	\$ 2658
	29-2066SC Letter Ped	66	20 ⁷ / ₁₆	30	-	-	217	27.9	\$ 2308

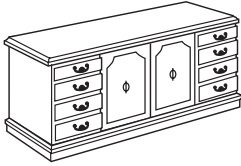
Description

- Tray/File/Box in Pedestals
- Fixed Storage Shelf Behind Doors
- Profiled on 3 Sides for Flush Wall Application

NOTE: Recommended for application against a wall.

KNEESPACE CREDENZA FULL PEDESTAL	29-2072KC Legal Ped	72	20 ⁷ / ₁₆	30	31.5	-	197	30.5	\$ 2374
	29-2066KC Letter Ped	66	20 ⁷ / ₁₆	30	31.5	-	185	27.9	\$ 2158

Description

- Tray/File/Box in Pedestals
- Grommet in Back Panel
- Profiled on 3 Sides for Flush Wall Application

NOTE: Recommended for application against a wall.

For ordering options, see back of Arlington Identification card at the beginning of section.

For grommet options, see page 404.

Item	Model No.	W	D	H	K	R	Ship Wt	Cubic Ft	List Price
DOUBLE LATERAL FILE CREDENZA	29-2060DL	60	20 ⁷ / ₁₆	30	-	-	241	25.4	\$ 3057

Description

- Legal or Letter Filing
- Independent Locking System on Each Drawer
- Profiled on 3 Sides for Flush Wall Application

NOTE: Recommended for application against a wall.

FOUR DRAWER LATERAL FILE	29-2036L4	36	20 ⁷ / ₁₆	56	-	-	224	27.3	\$ 3200
--------------------------	-----------	----	---------------------------------	----	---	---	-----	------	---------

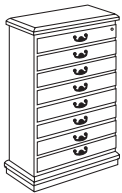
Description

- Central Locking
- Anti-Tilt System
- Profiled on 3 Sides for Flush Wall Application

NOTE: Recommended for application against a wall.

TWO DRAWER LATERAL FILE	29-2036L2	36	20 ⁷ / ₁₆	30	-	-	135	15.9	\$ 1837
	29-2030L2	30	20 ⁷ / ₁₆	30	-	-	123	13.1	\$ 1551



Description

- Independent Locking System
- Legal or Letter Filing
- Profiled on 3 Sides for Flush Wall Application

NOTE: Recommended for application against a wall.

For ordering options, see back of Arlington Identification card at the beginning of section.

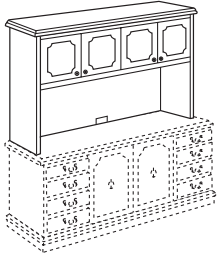
Item	Model No.	W	D	H	K	R	Ship Wt	Cubic Ft	List Price
WOOD DOOR SURFACE MOUNT HUTCH	29-1572HU	72	14	39 1/4	-	-	170	29.8	\$ 2896
	29-1566HU	66	14	39 1/4	-	-	162	26.9	\$ 2497

Description

- Grommet
- Storage Behind Wood Doors
- Profiled on 3 Sides for Flush Wall Application

NOTE: Recommended for application against a wall.

ACRYLIC DOOR SURFACE MOUNT HUTCH	29-1572AH	72	14	39 1/4	-	-	170	29.8	\$ 3141
	29-1566AH	66	14	39 1/4	-	-	162	26.9	\$ 2745

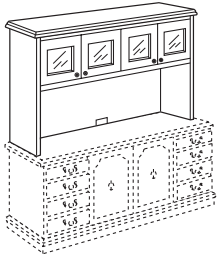
Description

- Grommet
- Storage Behind Acrylic Doors
- Profiled on 3 Sides for Flush Wall Application

Options: Specify & Add

CA	Clear Acrylic Door Inserts	Included
FA	Frosted Acrylic Door Inserts	Included

NOTE: Recommended for application against a wall.

For ordering options, see back of Arlington Identification card at the beginning of section.

For tackboard and tasklights, see page 421.

Item	Model No.	W	D	H	K	R	Ship Wt	Cubic Ft	List Price
WOOD DOOR WALL MOUNT HUTCH	29-1536WD	36	15	18 1/16	-	-	55	5.9	\$ 1528

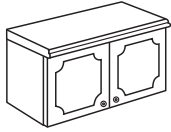
Description

- Mounts to Wall with Mounting Bracket Included
- Storage Behind Wood Doors
- Profiled on Front Edge Only for Multiple Unit Application

NOTE: Indiana Furniture will not be held liable for wall mount hutches that are not properly installed.
 NOTE: This unit may not align suitably when configured with other 2900 units due to the traditional overhang tops on those products.

ACRYLIC DOOR WALL MOUNT HUTCH	29-1536AW	36	15	18 1/16	-	-	55	5.9	\$ 1698
----------------------------------	-----------	----	----	---------	---	---	----	-----	---------

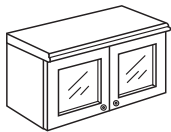
Description

- Mounts to Wall with Mounting Bracket Included
- Storage Behind Acrylic Doors
- Profiled on Front Edge Only for Multiple Unit Application

Options: Specify & Add

CA	Clear Acrylic Door Inserts	Included
FA	Frosted Acrylic Door Inserts	Included

NOTE: Indiana Furniture will not be held liable for wall mount hutches that are not properly installed.
 NOTE: This unit may not align suitably when configured with other 2900 units due to the traditional overhang tops on those products.

For ordering options, see back of Arlington Identification card at the beginning of section.

For tackboard and tasklights, see page 421.

Item	Model No.	W	D	H	K	R	Ship Wt	Cubic Ft	List Price
TOP UNIT BOOKCASE FOR 30" LATERAL	29-2848TU	28	15	48	-	-	73	15.8	\$ 969

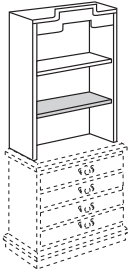
Description

- Fixed Bottom Shelf with 14" Clearance
- One Adjustable Shelf
- For Use on 30" Two Drawer Lateral Files or 60"- 66" Credenzas

NOTE: Recommended for application against a wall.

TOP UNIT BOOKCASE FOR 36" LATERAL	29-1534TU	34	15	45 ⁹ / ₁₆	-	-	78	17.8	\$ 1175
--------------------------------------	-----------	----	----	---------------------------------	---	---	----	------	---------

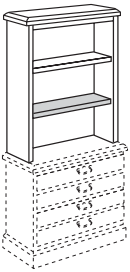
Description

- Fixed Bottom Shelf with 14" Clearance
- One Adjustable Shelf
- For Use on 36" Two Drawer Lateral Files
- Profiled on 3 Sides for Flush Wall Application

NOTE: Recommended for application against a wall.

DOOR BOOKCASE	29-2870DB	28	15	70	-	-	136	23.8	\$ 1621
---------------	-----------	----	----	----	---	---	-----	------	---------

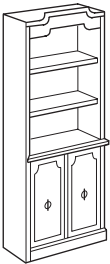

Description

- Storage Behind Hinged Doors
- Three Adjustable Shelves

NOTE: Recommended for application against a wall.

For ordering options, see back of Arlington Identification card at the beginning of section.

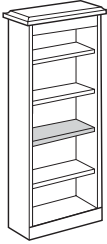
Item	Model No.	W	D	H	K	R	Ship Wt	Cubic Ft	List Price
BOOKCASES	29-3470BC Three Adjustable Shelves	34	15 1/2	68 9/16	-	-	165	25.0	\$ 1622
	29-3448BC Two Adjustable Shelves	34	15 1/2	47 13/16	-	-	93	16.0	\$ 1215

Description

- Open Bookcase
- One Fixed Shelf
- Three Adjustable Shelves
- Profiled on 3 Sides for Flush Wall Application

NOTE: Recommended for application against a wall.

BOOKCASES	29-2870BC Three Adjustable Shelves	30	15 1/2	68 9/16	-	-	125	18.0	\$ 1442
	29-2848BC Two Adjustable Shelves	30	15 1/2	47 13/16	-	-	89	16.0	\$ 1142

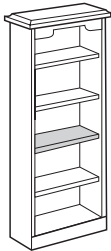
Description

- Open Bookcase
- One Fixed Shelf
- Profiled on 3 Sides for Flush Wall Application

NOTE: Recommended for application against a wall.

DOUBLE WARDROBE/STORAGE	29-3670WD	36	20	68 9/16	-	-	266	35.6	\$ 3374
----------------------------	-----------	----	----	---------	---	---	-----	------	---------

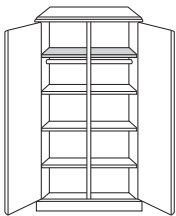

Description

- Fixed Top Shelf Behind Each Door
- Coat Rod Under Fixed Shelf
- Three Adjustable Shelves Behind Each Door
- Unfinished Back

NOTE: Recommended for application against a wall.

For ordering options, see back of Arlington Identification card at the beginning of section.

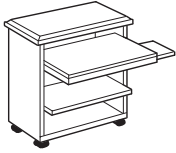
Item	Model No.	W	D	H	K	R	Ship Wt	Cubic Ft	List Price
MOBILE COMPUTER CART	29-2030MC	30	20 7/16	30	-	-	91	13.3	\$ 1116

Description

- Casters Provide Easy Moving
- Pull-Out Mouse Tray in Keyboard Drawer
- Pull-Out Printer Shelf
- Finished Back Panel with Open Clearance for Paper and Wire Management

COMPUTER WORK TABLE	29-2445CW	45	24	26 5/16	-	-	100	21.8	\$ 1717
	29-2436CW	36	24	26 5/16	-	-	86	17.7	\$ 1653

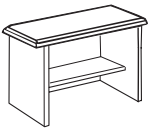
Description

- Fixed Shelf is 12" deep with 16" Clearance
- Grommet in Back Panel
- Grain Direction Runs Front to Back on Worksurface

Options: Specify & Add

CS-29BL	Optional Black Casters	\$ 150
---------	------------------------	--------

COMPUTER DESK WITH HUTCH	Left Ped	Right Ped	W	D	H	K	R	Ship Wt	Cubic Ft	List Price
	29-2648LP	29-2648RP	48	26	30	29 5/16	-	158	24.9	\$ 1809
	29-1246HU		45 7/8	12	25	-	-	54	10.2	\$ 715

Description

- Letter Width Pedestal
- Tray/File/Box in Pedestal
- Pull-Out Writing Shelf
- Pull-Out Keyboard Shelf
- Grommet in Back Panel
- Hutch has One Adjustable Shelf that can be Set for Left or Right Desk.

WORK TABLE	29-3672WT	72	36	30	64	-	125	11.39	\$ 1398
	29-3060WT	60	30	30	52	-	89	8.04	\$ 1152

Description

- Shipped KD

For ordering options, see back of Arlington Identification card at the beginning of section.

Item	Model No.	W	D	H	K	R	Ship Wt	Cubic Ft	List Price
CIRCULAR TABLE 	29-4848CT Accommodates 5 Chairs	48	48	30	-	-	60	5.7	\$ 1643
	29-4242CT Accommodates 4 Chairs	42	42	30	-	-	40	4.5	\$ 1146
	29-3636CT Accommodates 3-4 Chairs	36	36	30	-	-	35	3.4	\$ 996

Description

- Top and Base Sold Separately

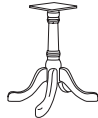
Options: Specify & Add

01-0606QB	Queen Anne Base						27	11.2	\$ 879
-----------	-----------------	--	--	--	--	--	----	------	--------

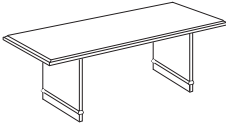
CONFERENCE TABLE ONE-PIECE TOP 	29-4296RT Accommodates 8 Chairs	96	42	30	-	-	140	12.5	\$ 2331
	29-3672RT Accommodates 6 Chairs	72	36	30	-	-	91	6.6	\$ 1932

Description

- One-Piece Top
- Two Bases
- Top and Bases Shipped Separately

Options: Specify & Add

29-2828TB	Standard Rectangular Base (2) - Includes Stretchers						104	7.0	Included
1-0606QB	Optional Queen Anne Base (2)						54	22.4	\$ 589

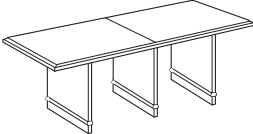
CONFERENCE TABLE TWO-PIECE TOP 	29-48144RT Accommodates 12 Chairs	144	48	30	-	-	315	22.0	\$ 4828
	29-48120RT Accommodates 10 Chairs	120	48	30	-	-	198	22.0	\$ 2940

Description

- Two-Piece Top
- Three Bases
- Top and Bases Shipped Separately

Options: Specify & Add

29-2828TB	Standard Rectangular Base (3) - Includes Stretchers						158	10.50	Included
1-0606QB	Optional Queen Anne Base (3)						80	33.60	\$ 883

For ordering options, see back of Arlington Identification card at the beginning of section.

Item	Model No.	W	D	H	K	R	Ship Wt	Cubic Ft	List Price
EXECUTIVE "L" UNIT	29-1	72	81	30	-	-	346	74.6	\$ 4260

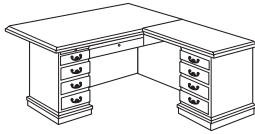
Consists of:
Qty

29-3672LP	1	• Left Pedestal Desk	\$ 2471
29-2445RF	1	• Executive Right Return	\$ 1789

OPERATIONAL "L" UNIT	29-2	72	81	30-27	-	-	344	71.3	\$ 3824
----------------------	------	----	----	-------	---	---	-----	------	---------



Consists of:
Qty

29-3672LP	1	• Left Pedestal Desk	\$ 2471
29-2445RR	1	• Operational Right Return	\$ 1353

All pedestal desks shown as left.
 All returns shown as right.

For ordering options, see back of Arlington Identification card at the beginning of section.

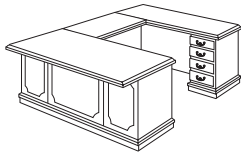
Item	Model No.	W	D	H	K	R	Ship Wt	Cubic Ft	List Price
EXECUTIVE "U" UNIT	29-3	72	105 5/16	30	-	-	446	88.4	\$ 5565

Consists of:
Qty

29-3672LP	1	• Left Pedestal Desk	\$ 2471
29-2450UF	1	• Bridge	\$ 957
29-2072RC	1	• Executive Right Return	\$ 2137

EXECUTIVE "U" UNIT	29-4	66	91 5/16	30	-	-	401	72.9	\$ 4964
--------------------	------	----	---------	----	---	---	-----	------	---------

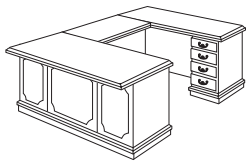
Consists of:
Qty

29-3066LP	1	• Left Pedestal Desk	\$ 2158
29-2442UF	1	• Bridge	\$ 914
29-2066RC	1	• Executive Right Return	\$ 1892

Shown as right U Groups.

For ordering options, see back of Arlington Identification card at the beginning of section.

TACKBOARD: SURFACE MOUNTED HUTCHES – 20 1/8" TALL

Size	Model #	COM ydg	COM, Grade 1, 2 or 3 List Price	Grade 4 List Price	Grade 5 List Price	Grade 6 List Price	Grade 7 List Price	Grade 8 List Price	Grade 9 List Price	Grade 10 List Price
66"	TB-2966H	2.00	\$ 336	\$ 518	\$ 600	\$ 690	\$ 810	\$ 937	\$ 1090	\$ 1263
72"	TB-2972H	2.25	\$ 357	\$ 561	\$ 653	\$ 755	\$ 890	\$ 1033	\$ 1204	\$ 1399

TACKBOARD: WALL MOUNTED HUTCHES – 21 7/8" TALL

Size	Model #	COM ydg	COM, Grade 1, 2 or 3 List Price	Grade 4 List Price	Grade 5 List Price	Grade 6 List Price	Grade 7 List Price	Grade 8 List Price	Grade 9 List Price	Grade 10 List Price
36"	TB-0136W	1.25	\$ 274	\$ 387	\$ 438	\$ 495	\$ 570	\$ 649	\$ 744	\$ 853

TASKLIGHTS – Includes 1 Wire Management Grommet

Model #	Size	Description	List Price
TL-0824	22 1/2" x 1 5/8" x 7/8"	84-LED, 7 Watts	\$ 234
TL-0848	47 1/2" x 1 5/8" x 7/8"	240-LED, 18 Watts	\$ 280

Jefferson™

Casegoods Collection

How to Order

MODEL NO.	DESCRIPTION	
46-4284DPS	Finish	PW
	Top Surface	W
	Edge	C2
	Molding	M
	Pull	ALB

All options must be labeled and specified.



Specifications



VENEER

Veneers on exposed surfaces are select grade sliced American Black Walnut and are carefully selected and matched to assure proper balance and consistency.

TOPS

C1 tops are 3-ply balanced construction, 1 1/8" thick with solid hardwood mitered rims. C2 tops are 5-ply balanced construction, 1 3/8" thick with solid hardwood mitered rims. Grain direction runs left to right unless otherwise noted.

CHASSIS CONSTRUCTION

Pedestals are of mortised and tenoned construction with all joints securely fastened with screws, hardwood screw rail brackets, and glue blocks. Solid hardwood parting rails assure a sturdy pedestal. Bases are solid hardwood with mitered corners. Superior construction offers tight tolerances and long term durability. All units equipped with heavy-duty, adjustable glides to ensure proper leveling and compensate for uneven floors.

DRAWERS

All drawer fronts are standard with elegant walnut bookmatched veneer faces. Fronts are 3-ply construction and 3/4" thick. Five-sided drawer construction allows for easy removal of drawer fronts. Drawer interiors are dovetail construction with 3/8" thick hardwood sides and backs and 5/32" thick hardboard bottoms. Lateral files have 1/4" thick drawer bottoms for storage applications. Drawer interiors are sanded, sealed, and finished to provide for a smooth, quality feel and appearance.

DRAWER SUSPENSION

File drawers have high quality, progressive full extension slides with precision steel ball bearings to ensure a smooth, quiet operation. Tray and box drawers are equipped with full extension ball-bearing action slides with positive stop action. All suspensions have a lifetime warranty.

FILING HARDWARE

All file drawers are standard with custom fitted filing systems designed to accommodate a variety of filing requirements. Legal width file drawers provide legal filing front to back, and letter or legal filing side to side. Letter width file drawers provide letter filing front to back, and letter or legal filing side to side.

LOCKING

Central locking is standard on all desks. One key in the lock cylinder locks all drawers in the desk. Removable lock cylinders allow for units to be re-keyed at a later date if required. Units are shipped randomly keyed as standard.

CORD MANAGEMENT

Route power and data cables away from the worksurface through inherent grommet placement. Black grommets are standard in back panels of assembled returns, bridge units, kneespace credenzas, and hutch units. A grommet is standard in tops of corner units. Grommets may be ordered in the tops of desks, returns, bridge units, credenzas, and component work-surfaces. See page 426 for all optional grommet locations.

Undersurface tracks are available for additional cord management. Silver grommets are also available. See Accessories.

FINISH

The multi-step, finish process used by Indiana Furniture provides years of lasting beauty. High quality finish materials offer distinctive grain clarity, superior resistance to normal wear, and easy maintenance. Wood veneer tops are shipped standard with satin sheen finish unless order is specified with "high sheen tops." Optional Jefferson 4600 Series high sheen tops feature a full-filled rubbed mirror-like appearance. See page 426 for high sheen top option.

Elegant Expression

Finish Options

WOOD VENEER (W) OR LAMINATE (P) TOPS – MUST SPECIFY



Legacy Walnut
LW



Harvest Walnut
HW



Artisan Walnut
AW



Mahogany on Walnut
MW



Presidential Walnut
PW



Traditional Mahogany
TM



Columbian Walnut
CO



Espresso Walnut
EW

Available in High Pressure Laminate Tops. (P)

Edge Options

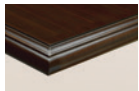

Jefferson
C1 - 1 1/4"



Jefferson
C2 - 1 3/4"

Pull Options

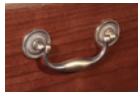

Jefferson
JEF

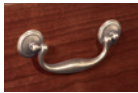

Wilmington
WLM

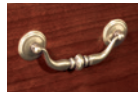

Arlington B
ARB



Liberty
ALB

Molding

All units ship with decorative pencil molding unless specified "without molding". Please denote "No Molding" on purchase order. Modular components offer molding as an option and at an upcharge. See page 426 for modular molding options.

COORDINATING PRODUCTS

Jefferson Casegoods offers options to coordinate with Cameo Conference and Cameo Reception.

INTERIOR DRAWER DIMENSIONS

JEFFERSON 4600 INTERIOR DRAWER DIMENSIONS

Item	Drawers	W	L	D
46-4284DPS	Tray	15 ³ / ₈	19 ³ / ₈	1 ²⁷ / ₃₂
46-4278DPS	Box	15 ³ / ₈	19 ³ / ₈	3 ²¹ / ₃₂
46-3672CHS	File	15 ³ / ₈	25 ³ / ₄	8 ²⁹ / ₃₂
	Center	30 ⁵ / ₈	19 ¹¹ / ₃₂	1 ²⁷ / ₃₂
46-3672DPS	Tray	12 ³ / ₈	19 ³ / ₈	1 ²⁷ / ₃₂
46-3066DPS	Box	12 ³ / ₈	19 ³ / ₈	3 ²¹ / ₃₂
	File	12 ³ / ₈	25 ³ / ₄	8 ²⁹ / ₃₂
	Center	30 ⁵ / ₈	19 ¹¹ / ₃₂	1 ²⁷ / ₃₂
46-4284DP	Box	15 ¹¹ / ₃₂	19 ¹¹ / ₃₂	3 ²¹ / ₃₂
46-4278DP	File	15 ³ / ₈	25 ²³ / ₃₂	11 ¹³ / ₃₂
46-3672CH	Center	30 ⁵ / ₈	19 ¹¹ / ₃₂	1 ²⁷ / ₃₂
46-3672LP	Box	15 ¹¹ / ₃₂	19 ¹¹ / ₃₂	3 ²¹ / ₃₂
46-3672RP	File	15 ³ / ₈	25 ²³ / ₃₂	11 ¹³ / ₃₂
	Center	25 ³ / ₄	19 ¹¹ / ₃₂	1 ²⁷ / ₃₂
46-3672DP	Box	12 ¹¹ / ₃₂	19 ¹¹ / ₃₂	3 ²¹ / ₃₂
46-3066DP	File	12 ³ / ₈	25 ²³ / ₃₂	11 ¹³ / ₃₂
	Center	30 ⁵ / ₈	19 ¹¹ / ₃₂	1 ²⁷ / ₃₂
46-3066LP	Box	12 ¹¹ / ₃₂	19 ¹¹ / ₃₂	3 ²¹ / ₃₂
46-3066RP	File	12 ³ / ₈	25 ²³ / ₃₂	11 ¹³ / ₃₂
	Center	22 ⁷ / ₈	19 ¹¹ / ₃₂	1 ²⁷ / ₃₂
46-2445LF	Box	12 ¹¹ / ₃₂	16 ⁷ / ₃₂	3 ²¹ / ₃₂
46-2445RF	File	12 ³ / ₈	16 ⁷ / ₃₂	11 ¹³ / ₃₂
46-2072SC	Box	15 ¹¹ / ₃₂	16 ⁷ / ₃₂	3 ²¹ / ₃₂
46-2072KC	File	15 ³ / ₈	16 ⁷ / ₃₂	11 ¹³ / ₃₂
46-2072LC				
46-2072RC				
46-2066SC	Box	12 ¹¹ / ₃₂	16 ⁷ / ₃₂	3 ²¹ / ₃₂
46-2066KC	File	12 ³ / ₈	16 ⁷ / ₃₂	11 ¹³ / ₃₂
46-2066LC				
46-2066RC				
46-2036L2	File	30 ³ / ₄	16 ⁷ / ₃₂	8 ¹³ / ₃₂
46-2036L4				
46-2072LL				
46-2072RL				
46-2072DL				
46-1829MU	Box	25 ¹ / ₂	16 ⁷ / ₃₂	3 ²¹ / ₃₂
	File	25 ¹ / ₂	16 ⁷ / ₃₂	8 ¹³ / ₃₂
46-1829MF	File	25 ¹ / ₂	16 ⁷ / ₃₂	8 ¹³ / ₃₂
46-3672TD	Tray	30 ⁵ / ₈	19 ¹¹ / ₃₂	1 ²⁷ / ₃₂
46-3066TD				

FILING CAPABILITIES

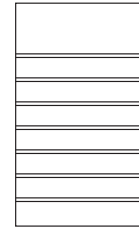
 15 ³/₈ x 25 ³/₄

Legal Front to Back

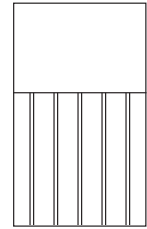

Legal Side to Side

 12 ³/₈ x 25 ²³/₃₂

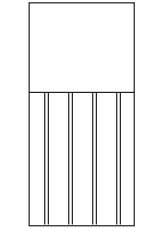

Letter Front to Back

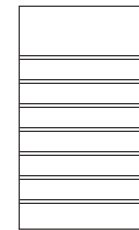

Legal Side to Side

 15 ³/₈ x 25 ²³/₃₂

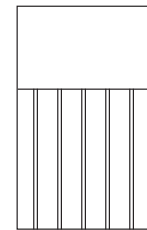
Legal Front to Back

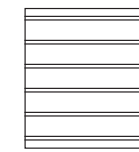

Legal Side to Side

 15 ³/₈ x 16 ⁷/₃₂

Legal Front to Back

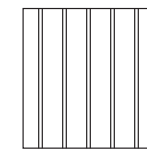

Legal Side to Side

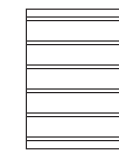
 12 ³/₈ x 16 ⁷/₃₂

Letter Front to Back

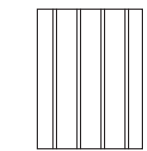

Legal Side to Side

 30 ³/₄ x 16 ⁷/₃₂

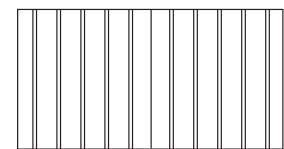

2 Rows Letter Front to Back

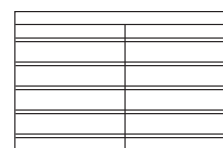

1 Row Legal Side to Side

 25 ¹/₂ x 16 ⁷/₃₂

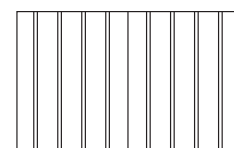
2 Rows Letter Front to Back



1 Row Legal Side to Side

GROMMET LOCATIONS

Add upcharge of \$48 list for each grommet.

Specify grommet locations.

- GL - Grommet Left
- GC - Grommet Center
- GR - Grommet Right

Example: 46-4284DP-GL-GR (Grommet Left, Grommet Right)

Grommets may be ordered in non-standard locations. Please call Customer Service to assist with how to order and additional lead time requirements.

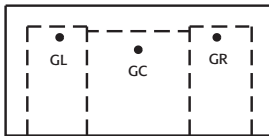

46-4284DPS
46-4284DP

GL/GR - 17" from ends, 32" from user side. GC - 28" from user side.

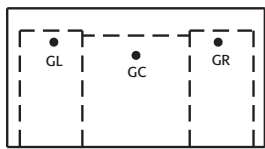

46-4278DPS
46-4278DP

GL/GR - 14" from ends, 32" from user side. GC - 28" from user side.

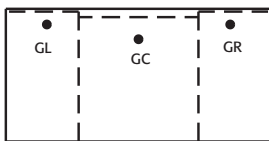

46-3672CHS
46-3672CH
46-3672LP
46-3672RP

GL/GR - 11" from ends, 32" from user side. GC - 28" from user side.

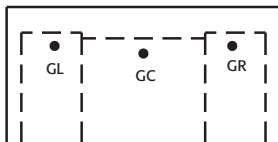

46-3672DPS
46-3672DP

GL/GR - 13" from ends, 26" from user side. GC - 24" from user side.

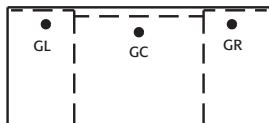

46-3066DPS
46-3066DP
46-3066LP
46-3066RP

GL/GR - 10" from ends, 26" from user side. GC - 24" from user side.



46-2450UF
46-2450UFH
46-2442UF
46-2442UFH

GL/GR - 4" from ends, 20" from user side. GC - 20" from user side.

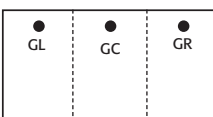

46-2445LF
46-2445RF

GL/GR - 4" from ends, 20" from user side. GC - 20" from user side.

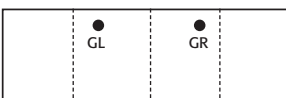

46-2072KC
46-2072LC
46-2072RC
46-2072LL
46-2072RL

GL/GR - 22 1/2" from ends, 17" from user side.

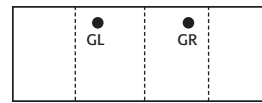
GROMMET LOCATIONS - CONTINUED

46-2066KC
46-2066LC
46-2066RC
46-2066LL
46-2066RL

GL/GR - 19 1/2" from ends, 17" from user side.

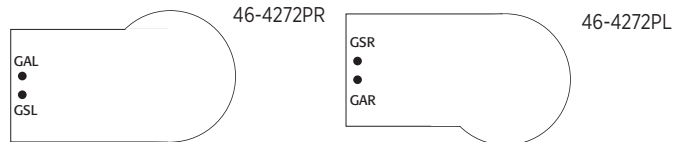

GAL/GSL/GSR/GAR - 12" from approach or seated side, 4" from end.

LOCKING FLIP DOWN CENTER DRAWER

Single and double pedestal desks and kneespace credenzas standard with a center drawer have an optional central locking flip down drawer front to be used as a center drawer or keyboard drawer. Drawer front is wood veneer with laminate drawer interior. Please specify with locking flip down front (LFD) and add \$51 list.

MODULAR COMPONENT MOLDING

The following models may be ordered with molding on left side, right side, or both sides. Please specify when ordering. Upcharge is \$54 list per panel.

46-2952BC 46-1829MS 46-2952WB 46-1829MF
46-2952MB 46-1829MU 46-2952GB

Example: 46-2952BC-MR with Molding on Right Side only.

APPROACH SIDE DICTATION SLIDES

The following models may be ordered with approach side pull-out dictation slide. Upcharge is \$384 list.

Specify with approach side dictation slide.

46-3672CH 46-3672LP 46-3066LP 46-3672CHS 46-3672DPS
46-3066DP 46-3672RP 46-3066RP 46-3066DPS

Center Grommet not available with this.

LOCKING PEDESTALS

Returns and single pedestal credenzas have optional locking pedestal with the lock positioned in the upper center of box drawer. Upcharge for return or single pedestal credenza locking pedestal is \$127 list.

Double pedestal credenzas have optional locking file drawers with the lock positioned in the upper center of both box drawers. Upcharge for locking double pedestal credenzas is \$252 list.

LOCKING HUTCH DOORS

Locking doors are available on hutches. Please specify with locking and add \$71 list.

46-1572HU 46-1566HU 46-1572GHU 46-1566GHU
46-1572MHU 46-1566MHU 46-1572WHU 46-1566WHU

Please specify with locking and add \$58 list.

46-1536WD

HIGH SHEEN WOOD VENEER TOPS

High sheen wood veneer top finish is available on Jefferson units. Jefferson high sheen tops feature a full-filled rubbed mirror-like appearance.

"High Sheen Tops" must be specified on order.

Contact Customer Service for pricing and lead time.

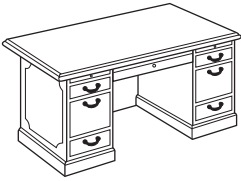
Item	Model No.	W	D	H	K	R	Ship Wt	Cubic Ft	List Price
EXECUTIVE DOUBLE PED DESK TRAY/FILE/BOX 	46-4284DPS Chassis 72W x 36D - Legal Ped	84	42	30	32 1/2	5	458	67.4	C1 \$ 7308 C2 \$ 7565
	46-4278DPS Chassis 72W x 36D - Legal Ped	78	42	30	32 1/2	5	408	62.6	C1 \$ 6480 C2 \$ 6719
	46-3672CHS Chassis 72W x 36D - Legal Ped	72	36	30	32 1/2	-	358	50.0	C1 \$ 6123 C2 \$ 6311
	46-3672DPS Chassis 66W x 30D - Letter Ped	72	36	30	32 1/2	5	358	50.0	C1 \$ 4384 C2 \$ 4572
	46-3066DPS Chassis 66W x 30D - Letter Ped	66	30	30	32 1/2	-	300	38.7	C1 \$ 4233 C2 \$ 4377

Description

- Central Locking in Center Drawer
- Tray/File/Box in Both Pedestals
- Pull Out Writing Shelves

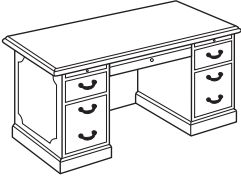
EXECUTIVE DOUBLE PED DESK BOX/FILE 	46-4284DP Chassis 72W x 36D - Legal Ped	84	42	30	32 1/2	5	458	67.4	C1 \$ 6609 C2 \$ 6867
	46-4278DP Chassis 72W x 36D - Legal Ped	78	42	30	32 1/2	5	408	62.6	C1 \$ 5860 C2 \$ 6099
	46-3672CH Chassis 72W x 36D - Legal Ped	72	36	30	32 1/2	-	358	50.0	C1 \$ 5646 C2 \$ 5834
	46-3672DP Chassis 66W x 30D - Letter Ped	72	36	30	32 1/2	5	358	50.0	C1 \$ 4153 C2 \$ 4342
	46-3066DP Chassis 66W x 30D - Letter Ped	66	30	30	32 1/2	-	300	38.7	C1 \$ 3983 C2 \$ 4128

Description

- Central Locking in Center Drawer
- Box/File in Both Pedestals
- Pull Out Writing Shelves

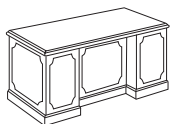

Approach View

For ordering options, see back of Jefferson Identification card at the beginning of section.

For grommet options, see page 426.

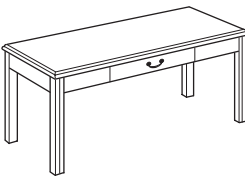
Item	Model No.	W	D	H	K	R	Ship Wt	Cubic Ft	List Price
	46-3672TD	72	36	30	-	-	120	12.2	C1 \$ 2449 C2 \$ 2637
	46-3066TD	66	30	30	-	-	110	9.7	C1 \$ 2049 C2 \$ 2194

Description

- Center Drawer
- Top and Legs Ship Separately

Options: Specify & Add

46-0202TL	Standard Straight Legs	20	.90	Included
46-0202QL	Optional Queen Anne Legs	20	3.12	\$ 1469

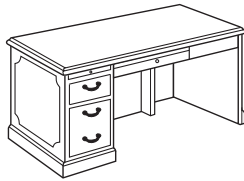
**EXECUTIVE SINGLE PED DESK
BOX/FILE**

		Left Ped	Right Ped	W	D	H	K	R	Ship Wt	Cubic Ft	List Price
	46-3672LP	46-3672RP	72	36	30	28 1/4	-	-	315	50.4	C1 \$ 3903 C2 \$ 4092
	46-3066LP	46-3066RP	66	30	30	25 1/4	-	-	262	38.7	C1 \$ 3548 C2 \$ 3692

Description

- Central Locking
- Box/File in Pedestal
- Pull Out Writing Shelf

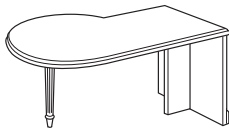
P-TOP

		Left Ped	Right Ped	W	D	H	K	R	Ship Wt	Cubic Ft	List Price
	46-4272PL	46-4272PR	72	42-36	30	-	-	-	163	58.0	C1 \$ 3739 C2 \$ 3960

Description

- End Support
- Wood Cabaret Leg
- Not Recommended for Freestanding Applications

All pedestal desks shown as left.

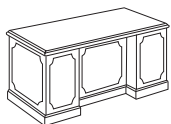

Approach View

For ordering options, see back of Jefferson Identification card at the beginning of section.

For grommet options, see page 426.

Item	Model No.	W	D	H	K	R	Ship Wt	Cubic Ft	List Price	
EXECUTIVE RETURN BOX/FILE	Left Ped	Right Ped								
	46-2445LF	46-2445RF	45	24	30	27 3/4	-	165	21.8	C1 \$ 2631 C2 \$ 2710

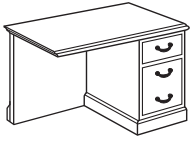
Description

- Box/File in Pedestal
- Letter Width Pedestal
- Grommet in Back Panel
- Grain Direction Runs Front to Back on Worksurface

EXECUTIVE BRIDGE FULL MODESTY	46-2450UF	50	24	30	50	-	89	5.4	C1 \$ 1364 C2 \$ 1452
	46-2442UF	42	24	30	42	-	85	4.6	C1 \$ 1286 C2 \$ 1359

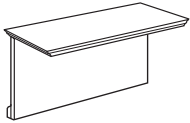
Description

- Grommet in Back Panel
- Grain Direction Runs Front to Back on Worksurface
- Hinged Back Panel

NOTE: Keyboards can not be factory installed.

EXECUTIVE BRIDGE HALF MODESTY	46-2450UFH	50	24	11 1/32	50	-	89	5.4	C1 \$ 1193 C2 \$ 1279
	46-2442UFH	42	24	11 1/32	42	-	85	4.6	C1 \$ 1123 C2 \$ 1197

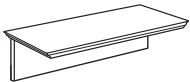
Description

- Grain Direction Runs Front to Back on Worksurface
- Hinged Back Panel

NOTE: Keyboards can not be factory installed.

All returns shown as right.

For ordering options, see back of Jefferson Identification card at the beginning of section.

For grommet options, see page 426.

Item	Model No.	W	D	H	K	R	Ship Wt	Cubic Ft	List Price
CORNER UNIT	46-4242CU	42	42	30	25 ¹⁵ / ₃₂	-	145	34.5	C1 \$ 2556 C2 \$ 2685
	46-3636CU	36	36	30	17	-	135	25.7	C1 \$ 2404 C2 \$ 2498

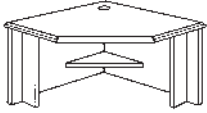
Description

- Connects to 24" Deep Bridge and Return Units
- Grommet in Top
- Grain Direction Runs Front to Back on Worksurface
- Approach Side Features Base Molding as well as Decorative Pencil Molding on Both Modesty Panels
- Freestand Support Unit

NOTE: Not all keyboards will fit the 46-3636CU. Recommended keyboards are 1-KCWR, 1-KCPR, and 1-KC.

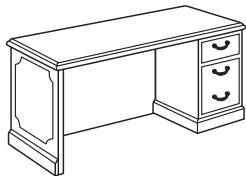
**EXECUTIVE CREDENZA
BOX/FILE**

	Left Ped	Right Ped	W	D	H	K	R	Ship Wt	Cubic Ft	List Price
46-2072LC Legal Ped	46-2072RC	72	20	30	28 ¹ / ₄	-	254	29.0	C1 \$ 2991 C2 \$ 3096	
	46-2066LC Letter Ped	46-2066RC	66	20	30	25 ¹ / ₄	-	195	26.6	C1 \$ 2948 C2 \$ 3045

Description

- Box/File in Pedestal
- Grommet in Back Panel

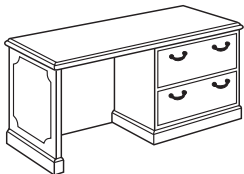
**EXECUTIVE CREDENZA
LATERAL/LATERAL**

	Left Ped	Right Ped	W	D	H	K	R	Ship Wt	Cubic Ft	List Price
46-2072LL	46-2072RL	72	20	30	12 ⁷ / ₈	-	274	29.0	C1 \$ 3112 C2 \$ 3217	
	46-2066LL	46-2066RL	66	20	30	6 ⁷ / ₈	-	220	26.6	C1 \$ 3047 C2 \$ 3144

Description

- Locking File
- Lateral/Lateral in Pedestal
- Grommet in Back Panel
- Legal or Letter Filing

All credenzas shown as right.

For ordering options, see back of Jefferson Identification card at the beginning of section.

For grommet options, see page 426.

Item	Model No.	W	D	H	K	R	Ship Wt	Cubic Ft	List Price
TRANSACTION RISER FOR DESKS/CREDENZAS	46-1272TR	72	12	13 1/32	-	-	54	9.7	C1 \$ 1504
	For Use with 72" Worksurfaces								
	46-1266TR	66	12	13 1/32	-	-	55	8.3	C1 \$ 1358
	For Use with 66" Worksurfaces								

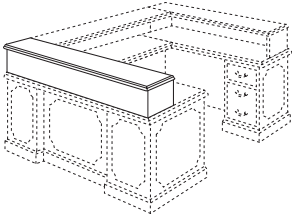
Description

- Freestanding Riser for Desks or Credenzas
- May Be Used in Conjunction with Return Risers or Bridge Risers

TRANSACTION RISER FOR RETURNS	Left Ped	Right Ped	W	D	H	K	R	Ship Wt	Cubic Ft	List Price
		46-0969LU	46-0969RU	68 13/16	9	13 1/32	-	-	45	6.8
	For Use with 36" Desks and 45" Returns									C2 \$ 1486
	46-0963LU	46-0963RU	62 13/16	9	13 1/32	-	-	40	6.2	C1 \$ 1293
	For Use with 30" Desks and 45" Returns									C2 \$ 1334

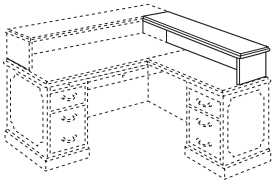
Description

- Must Be Used in Conjunction with a Desk Riser
- Grain Direction Runs Left to Right on Worksurface if Laminate Top is Specified

TRANSACTION RISER FOR BRIDGES	46-0981BU	81 5/8	9	13 1/32	-	-	48	8.2	C1 \$ 1392	
	For Use with 36" Desk and 50" Bridge									C2 \$ 1446
	46-0968BU	67 5/8	9	13 1/32	-	-	43	6.8	C1 \$ 1249	
	For Use with 30" Desk and 42" Bridge									C2 \$ 1294

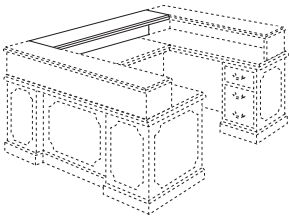
Description

- Must Be Used in Conjunction with Two Desks/Credenza Risers
- Grain Direction Runs Left to Right on Worksurface if Laminate Top is Specified

For ordering options, see back of Jefferson Identification card at the beginning of section.

Item	Model No.	W	D	H	K	R	Ship Wt	Cubic Ft	List Price
STORAGE CREDENZA FULL PEDESTAL	46-2072SC Legal Ped	72	20	30	-	-	296	29.0	C1 \$ 4009 C2 \$ 4114
	46-2066SC Letter Ped	66	20	30	-	-	271	26.6	C1 \$ 3582 C2 \$ 3679

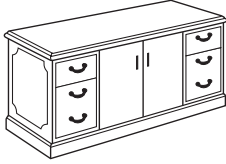
Description

- Box/File in Pedestals
- Fixed Storage Shelf Behind Doors
- Legal or Letter Filing

KNEESPACE CREDENZA FULL PEDESTAL	46-2072KC Legal Ped	72	20	30	32 1/2	-	275	29.0	C1 \$ 3569 C2 \$ 3674
	46-2066KC Letter Ped	66	20	30	32 1/2	-	216	26.6	C1 \$ 3241 C2 \$ 3338

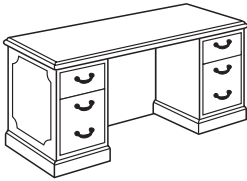
Description

- Box/File in Pedestals
- Grommet in Back Panel
- Legal or Letter Filing

DOUBLE LATERAL CREDENZA FULL PEDESTAL	46-2072DL	72	20	30	-	-	304	29.0	C1 \$ 4639 C2 \$ 4744
--	-----------	----	----	----	---	---	-----	------	--------------------------

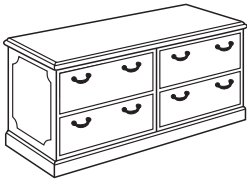

Description

- Dual Locking
- Legal or Letter Filing Side to Side or Front to Back
- Anti-Tilt System

For ordering options, see back of Jefferson Identification card at the beginning of section.

For grommet options, see page 426.

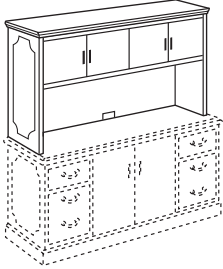
Item	Model No.	W	D	H	K	R	Ship Wt	Cubic Ft	List Price
WOOD DOOR SURFACE MOUNT HUTCH	46-1572HU	72	15	39 ^{25/32}	-	-	192	30.2	C1 \$ 4203 C2 \$ 4283
	46-1566HU	66	15	39 ^{25/32}	-	-	200	26.9	C1 \$ 3969 C2 \$ 4041

Description

- Storage Behind Wood Doors
- Grommet
- 21 1/2" Clearance Below Doors

MESH DOOR SURFACE MOUNT HUTCH	46-1572MHU	72	15	39 ^{25/32}	-	-	225	30.2	C1 \$ 5231 C2 \$ 5310
	46-1566MHU	66	15	39 ^{25/32}	-	-	200	26.9	C1 \$ 4954 C2 \$ 5027

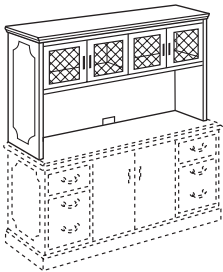

Description

- Storage Behind Wood Framed Mesh Doors
- Grommet
- 21 1/2" Clearance Below Doors

1-BM	Antique Brass Mesh with Brass Pull	\$	Std
1-AM	Liberty Aluminum Mesh with ALB Pull	\$	491

NOTE: 1-BM is only available when a Brass Pull has been specified. 1-AM is only available when ALB Pull has been specified.

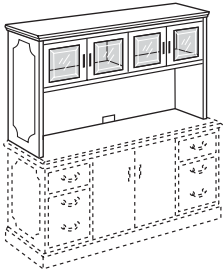
GLASS DOOR SURFACE MOUNT HUTCH	46-1572GHU	72	15	39 ^{25/32}	-	-	225	30.2	C1 \$ 4674 C2 \$ 4753
	46-1566GHU	66	15	39 ^{25/32}	-	-	200	26.9	C1 \$ 4426 C2 \$ 4499



Description

- Storage Behind Wood Framed Glass Doors
- Grommet
- 21 1/2" Clearance Below Doors

Options: Specify & Add

1-CL	Clear Glass Doors	\$	Std
1-CR	Cracked Ice Glass Doors	\$	654

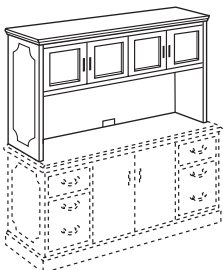

WOOD INSERT DOOR SURFACE MOUNT HUTCH	46-1572WHU	72	15	39 ^{25/32}	-	-	175	23.5	C1 \$ 4447 C2 \$ 4526
	46-1566WHU	66	15	39 ^{25/32}	-	-	150	20.2	C1 \$ 4211 C2 \$ 4284

Description

- Storage Behind Wood Framed Doors
- Grommet
- 21 1/2" Clearance Below Doors

For ordering options, see back of Jefferson Identification card at the beginning of section.

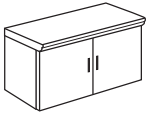
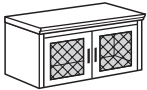
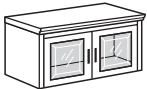
Tackboards and tasklights sold on page 450.

Item	Model No.	W	D	H	K	R	Ship Wt	Cubic Ft	List Price
WOOD DOOR WALL MOUNT HUTCH	46-1536WD	36	15	18 1/32	-	-	55	5.9	C1 \$ 1899 C2 \$ 1939
	Description	<ul style="list-style-type: none"> Mounts to Wall with Mounting Brackets Included Storage Behind Wood Doors Profiled on Front Edge Only for Multiple Unit Application 							
	NOTE: Indiana Furniture will not be held liable for wall mount hutches that are not properly installed. NOTE: This unit may not align suitably when configured with other 4600 units due to the traditional overhang tops on those products.								
MESH DOOR WALL MOUNT HUTCH	46-1536MWD	36	15	18 1/32	-	-	55	5.9	C1 \$ 2427 C2 \$ 2468
	Description	<ul style="list-style-type: none"> Mounts to Wall with Mounting Brackets Included Storage Behind Wood Framed Mesh Doors Profiled on Front Edge Only for Multiple Unit Application 							
	Options: Specify & Add								
	1-BM	Antique Brass Mesh with Brass Pull							\$ Std
	1-AM	Liberty Aluminum Mesh with ALB Pull							\$ 246
	NOTE: Indiana Furniture will not be held liable for wall mount hutches that are not properly installed. NOTE: This unit may not align suitably when configured with other 4600 units due to the traditional overhang tops on those products. NOTE: 1-BM is only available when a Brass Pull has been specified. 1-AM is only available when ALB Pull has been specified.								
GLASS DOOR WALL MOUNT HUTCH	46-1536GWD	36	15	18 1/32	-	-	55	5.9	C1 \$ 2168 C2 \$ 2208
	Description	<ul style="list-style-type: none"> Mounts to Wall with Mounting Brackets Included Storage Behind Wood Framed Glass Doors Profiled on Front Edge Only for Multiple Unit Application 							
	Options: Specify & Add								
	1-CL	Clear Glass Doors							\$ Std
	1-CR	Cracked Ice Glass Doors							\$ 327
	NOTE: Indiana Furniture will not be held liable for wall mount hutches that are not properly installed. NOTE: This unit may not align suitably when configured with other 4600 units due to the traditional overhang tops on those products.								
WOOD INSERT DOOR WALL MOUNT HUTCH	46-1536WWD	36	15	18 1/32	-	-	55	5.9	C1 \$ 2064 C2 \$ 2104
	Description	<ul style="list-style-type: none"> Mounts to Wall with Mounting Brackets Included Storage Behind Wood Framed Doors Profiled on Front Edge Only for Multiple Unit Application 							
	NOTE: Indiana Furniture will not be held liable for wall mount hutches that are not properly installed. NOTE: This unit may not align suitably when configured with other 4600 units due to the traditional overhang tops on those products.								

For ordering options, see back of Jefferson Identification card at the beginning of section.

Tackboards and tasklights sold on page 450.

Item	Model No.	W	D	H	K	R	Ship Wt	Cubic Ft	List Price
VERTICAL HUTCH OPEN STORAGE SURFACE MOUNT	46-1572VHO	72	15	51 1/32	-	-	231	38.7	C1 \$ 2846
	For use with 72" credenzas								C2 \$ 2925
	46-1566VHO	66	15	51 1/32	-	-	185	36.0	C1 \$ 2706
	For use with 66" credenzas								C2 \$ 2778

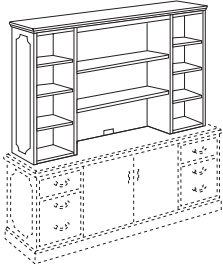
Description

- Fixed Shelves in Middle Section
- Adjustable Shelves in End Sections
- Grommet

VERTICAL HUTCH GRILLE DOORS SURFACE MOUNT	46-1572VHM	72	15	51 1/32	-	-	231	38.7	C1 \$ 3562
	For use with 72" credenzas								C2 \$ 3641
	46-1566VHM	66	15	51 1/32	-	-	226	36.0	C1 \$ 3419
	For use with 66" credenzas								C2 \$ 3492

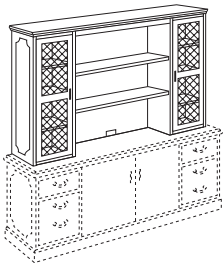
Description

- Fixed Shelves in Middle Section
- Adjustable Shelves in End Sections
- Grommet

Options: Specify & Add

1-BM	Antique Brass Mesh with Brass Pull	\$	Std
1-AM	Liberty Aluminum Mesh with ALB Pull	\$	491

NOTE: 1-BM is only available when a Brass Pull has been specified. 1-AM is only available when ALB Pull has been specified.

For ordering options, see back of Jefferson Identification card at the beginning of section.

Item	Model No.	W	D	H	K	R	Ship Wt	Cubic Ft	List Price
VERTICAL HUTCH WOOD DOORS SURFACE MOUNT	46-1572VHW For Use with 72" Credenzas	72	15	51 1/32	-	-	244	38.7	C1 \$ 3274 C2 \$ 3354
	46-1566VHW For Use with 66" Credenzas	66	15	51 1/32	-	-	231	36.0	C1 \$ 3133 C2 \$ 3205

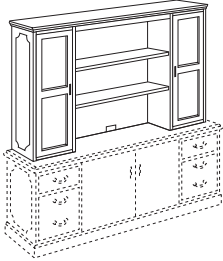
Description

- Fixed Shelves in Middle Section
- Adjustable Shelves in End Sections
- Grommet

VERTICAL HUTCH GLASS DOORS SURFACE MOUNT	46-1572VHG For Use with 72" Credenzas	72	15	51 1/32	-	-	244	38.7	C1 \$ 3419 C2 \$ 3499
	46-1566VHG For Use with 66" Credenzas	66	15	51 1/32	-	-	231	36.0	C1 \$ 3274 C2 \$ 3347

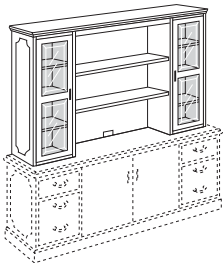
Description

- Fixed Shelves in Middle Section
- Adjustable Shelves in End Sections
- Grommet

Options: Specify & Add

1-CL	Clear Glass Doors	\$	Std
1-CR	Cracked Ice Glass Doors	\$	654

For ordering options, see back of Jefferson Identification card at the beginning of section.

Item	Model No.	W	D	H	K	R	Ship Wt	Cubic Ft	List Price
FOUR DRAWER LATERAL FILE	46-2036L4	36	20	55 ⁹ / ₃₂	-	-	290	27.5	C1 \$ 3946 C2 \$ 3999

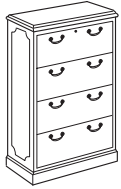
Description

- Central Locking System
- Anti-Tilt System
- Legal or Letter Filing Side to Side or Front to Back

TWO DRAWER LATERAL FILE	46-2036L2	36	20	30	-	-	152	14.9	C1 \$ 2412 C2 \$ 2464
----------------------------	-----------	----	----	----	---	---	-----	------	--------------------------

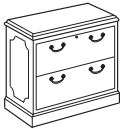
Description

- Central Locking System
- Anti-Tilt System
- Legal or Letter Filing Side to Side or Front to Back

For ordering options, see back of Jefferson Identification card at the beginning of section.

Item	Model No.	W	D	H	K	R	Ship Wt	Cubic Ft	List Price
TOP UNIT BOOKCASE	46-1534TU	34	15	51 1/32	-	-	125	19.0	C1 \$ 1799 C2 \$ 1836

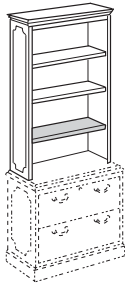
Description

- Fixed Bottom Shelf with 12" Clearance
- Two Adjustable Shelves
- For Use on Two Drawer Lateral Files

BOOKCASES	46-3470BC	34	15	69 17/32	-	-	152	26.1	C1 \$ 2435 C2 \$ 2472
	Three Adjustable Shelves								
	46-3456BC	34	15	55 9/32	-	-	140	20.1	C1 \$ 2077 C2 \$ 2113
	Two Adjustable Shelves								

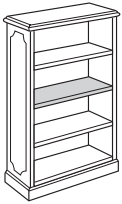
Description

- One Fixed Shelf

WARDROBE/STORAGE CABINET	46-3670WD	36	20	69 5/32	-	-	310	34.2	C1 \$ 5860 C2 \$ 5913
-----------------------------	-----------	----	----	---------	---	---	-----	------	--------------------------

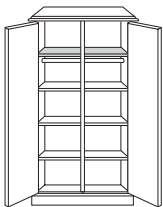
Description

- Fixed Top Shelf Behind Each Door
- Coat Rod Under Fixed Shelf
- Three Adjustable Shelves Behind Each Door
- Adjustable Shelves Can Be Easily Removed for Wardrobe Application

For ordering options, see back of Jefferson Identification card at the beginning of section.

Item	Model No.	W	D	H	K	R	Ship Wt	Cubic Ft	List Price
COMPUTER WORK TABLE	46-2445CW	45	24	26 ⁹ / ₃₂	41 ⁷ / ₁₆	-	120	21.8	C1 \$ 1865 C2 \$ 1943
	46-2436CW	36	24	26 ⁹ / ₃₂	32 ⁷ / ₁₆	-	115	17.6	C1 \$ 1703 C2 \$ 1767

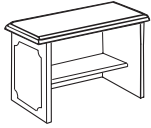

Description

- Fixed Shelf with 15 ⁷/₈" Clearance
- Grommet in Back Panel
- Grain Direction Runs Front to Back on Worksurface

Options: Specify & Add

CS-46BL	Optional Black Casters	\$	150
---------	------------------------	----	-----

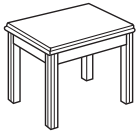
END TABLE	46-1824ET	24	18	21 ²⁵ / ₃₂	-	-	25	2.0	C1 \$ 836 C2 \$ 867
-----------	-----------	----	----	----------------------------------	---	---	----	-----	------------------------

Description

- Shipped KD

LAMP TABLE	46-2828LT	28	28	21 ²⁵ / ₃₂	-	-	37	3.3	C1 \$ 1064 C2 \$ 1121
------------	-----------	----	----	----------------------------------	---	---	----	-----	--------------------------

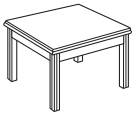
Description

- Shipped KD

MAGAZINE TABLE	46-1847MT	47	18	15 ²⁵ / ₃₂	-	-	42	3.4	C1 \$ 1006 C2 \$ 1068
----------------	-----------	----	----	----------------------------------	---	---	----	-----	--------------------------

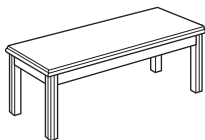
Description

- Shipped KD

Options: Specify & Add

SH-46	Optional 30" H Legs	20	.90	\$	158
-------	---------------------	----	-----	----	-----

For ordering options, see back of Jefferson Identification card at the beginning of section.

Item	Model No.	W	D	H	K	R	Ship Wt	Cubic Ft	List Price
KEYBOARD FLIP DRAWER	46-2410FD	24	15 3/4	3 1/16	-	-	12	2.0	\$ 620

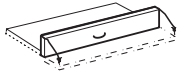
Description

- Flip Down Front
- Wood Shelf
- Use on Any Open Kneespace 24" or Larger

Options: Specify & Add

Factory Installed	\$ 130
-------------------	--------

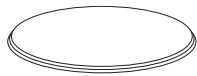
CIRCULAR TABLES

SIN 711-11

46-4848CT Accommodates 5 Chairs	48	48	30	-	-	58	5.9	C1 \$ 2640 C2 \$ 2809
46-4242CT Accommodates 4 Chairs	42	42	30	-	-	51	4.5	C1 \$ 2298 C2 \$ 2426
46-3636CT Accommodates 3-4 Chairs	36	36	30	-	-	43	3.3	C1 \$ 2069 C2 \$ 2164

Description

- Top and Base Sold Separately

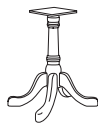
Options: Specify & Add

01-0606QB Queen Anne Base	26	10.8	\$ 879
---------------------------	----	------	--------

For ordering options, see back of Jefferson Identification card at the beginning of section.

Item	Model No.	W	D	H	K	R	Ship Wt	Cubic Ft	List Price
OVERHEAD CORNICE FRAME 	46-1560FC Frame for 2 Bookcases	60	15	3 1/2	-	-	18	3.1	\$ 400
	46-1531FC Frame for 1 Bookcase	31	15	3 1/2	-	-	10	1.6	\$ 293

NOTE: Not for use on bookcases in freestanding applications.

OVERHEAD CORNICE FRAME WITH INSERT PANEL 	46-1589FC Frame for 3 Bookcases	89	15	3 1/2	-	-	30	4.5	\$ 699
---	------------------------------------	----	----	-------	---	---	----	-----	--------

NOTE: Not for use on bookcases in freestanding applications

BOOKCASE TOP 	46-1560TP Top for 2 Bookcases	59 1/2	15	1 1/32	-	-	30	3.1	C1 \$ 642 C2 \$ 709
	46-1531TP Top for 1 Bookcase	30 1/2	15	1 1/32	-	-	16	1.6	C1 \$ 389 C2 \$ 423

For ordering options, see back of Jefferson Identification card at the beginning of section.

JEFFERSON™ 4600 SERIES
 Modular Components

Item	Model No.	W	D	H	K	R	Ship Wt	Cubic Ft	List Price
BOOKCASE	46-2952BC	29	13 1/2	50	-	-	84	14.6	\$ 1130

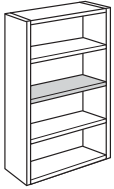
Description

- One Fixed Shelf
- Two Adjustable Shelves

NOTE: For freestanding application of bookcase, top, and base are required.
 NOTE: Bookcases are recommended for application against a wall.

GRILLE MESH DOOR BOOKCASE	46-2952MB	29	13 1/2	50	-	-	97	14.6	\$ 1972
---------------------------	-----------	----	--------	----	---	---	----	------	---------

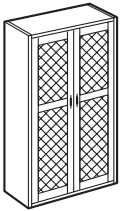
Description

- One Fixed Shelf
- Two Adjustable Shelves

Options: Specify & Add

1-BM	Antique Brass Mesh with Brass Pull	\$	Std
1-AM	Liberty Aluminum Mesh with ALB Pull	\$	491

NOTE: For freestanding application of bookcase, top, and base are required.
 NOTE: Bookcases are recommended for application against a wall.
 NOTE: 1-BM is only available when a Brass Pull has been specified. 1-AM is only available when ALB Pull has been specified.

WOOD DOOR BOOKCASE	46-2952WB	29	13 1/2	50	-	-	114	14.6	\$ 2314
--------------------	-----------	----	--------	----	---	---	-----	------	---------

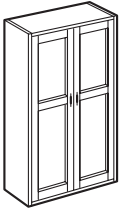
Description

- One Fixed Shelf
- Two Adjustable Shelves

NOTE: For freestanding application of bookcase, top, and base are required.
 NOTE: Bookcases are recommended for application against a wall.

GLASS DOOR BOOKCASE	46-2952GB	29	13 1/2	50	-	-	123	14.6	\$ 2314
---------------------	-----------	----	--------	----	---	---	-----	------	---------

Description

- One Fixed Shelf
- Two Adjustable Shelves

Options: Specify & Add

1-CL	Clear Glass Doors	\$	Std
1-CR	Cracked Ice Glass Doors	\$	654

NOTE: For freestanding application of bookcase, top, and base are required.
 NOTE: Bookcases are recommended for application against a wall.

For ordering options, see back of Jefferson Identification card at the beginning of section.

Item	Model No.	W	D	H	K	R	Ship Wt	Cubic Ft	List Price	
MODULAR PEDESTAL	Left Ped									
	Right Ped									
	46-2019FPL	46-2019FPR	20	19	28 1/4	-	-	50	8.0	\$ 787

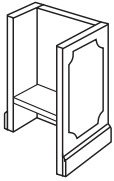
Description

- Modular Pedestal Shell
- Used to Create Single Pedestal and Credenzas from Modular Components
- Standard with Pencil Molding

MODULAR BACK PANEL	46-1028BP	10 1/8	3/4	24	-	-	20	0.6	\$ 429
--------------------	-----------	--------	-----	----	---	---	----	-----	--------

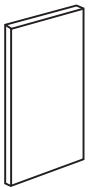
Description

- For Use Between Pedestals in Modular Single Pedestal Credenza Applications
- Will Leave 4" Gap from Modesty Panel to Floor

MODULAR BACK PANEL	46-3928BP	39 1/8	3/4	24	-	-	40	2.1	\$ 487
--------------------	-----------	--------	-----	----	---	---	----	-----	--------

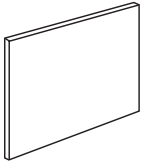

Description

- For Use Between Pedestals in Modular Single Pedestal Credenza Applications
- Will Leave 4" Gap from Modesty Panel to Floor

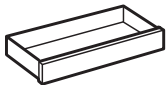
BOOKCASE BASE	46-1560BS	59 1/8	14 5/8	4 1/4	-	-	15	3.1	\$ 372
	Base for 2 Bookcases								
	46-1531BS	30 1/8	14 5/8	4 1/4	-	-	10	1.6	\$ 270
	Base for 1 Bookcase								



For ordering options, see back of Jefferson Identification card at the beginning of section.

Item	Model No.	W	D	H	K	R	Ship Wt	Cubic Ft	List Price		
CABINET/CREDENZA TOP 	46-2089TP	88 1/2	20	1 1/32	-	-	53	5.8	C1 \$	1071	
	Top for 3 Cabinets - Optional Center Grommet, Add \$47									C2 \$	1202
	46-2060TP	59 1/2	20	1 1/32	-	-	38	4.0	C1 \$	706	
Top for 2 Cabinets									C2 \$	793	
46-2031TP									C1 \$	400	
Top for 1 Cabinet									C2 \$	445	

CABINET/CREDENZA BASE 	46-2089BS	88 1/8	19 9/16	4 1/4	-	-	43	5.8	\$	736	
	Base for 3 Cabinets										
	46-2060BS	59 1/8	19 9/16	4 1/4	-	-	30	4.0	\$	499	
Base for 2 Cabinets											
46-2031BS									\$	321	
Base for 1 Cabinet											

For ordering options, see back of Jefferson Identification card at the beginning of section.

Item	Model No.	W	D	H	K	R	Ship Wt	Cubic Ft	List Price
MODULAR STORAGE	46-1829MS	29	18 1/2	24	-	-	92	9.8	\$ 1348

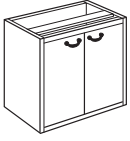
Description

- Two Doors
- Adjustable Shelf
- Finished Back

NOTE: Top and base are required.

MODULAR STORAGE BOX/BOX/FILE	46-1829MU	29	18 1/2	24	-	-	119	9.8	\$ 1835
---------------------------------	-----------	----	--------	----	---	---	-----	-----	---------

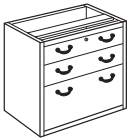
Description

- Central Locking
- Box/Box/File
- Legal or Letter Filing Side to Side or Letter Filing Front to Back
- Finished Back

NOTE: Top and base are required.

MODULAR STORAGE FILE/FILE	46-1829MF	29	18 1/2	24	-	-	117	9.8	\$ 1835
------------------------------	-----------	----	--------	----	---	---	-----	-----	---------

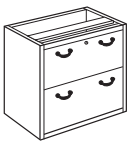

Description

- Central Locking
- File/File
- Top Drawer Styled as Two Box Drawers
- Legal or Letter Filing Side to Side or Letter Filing Front to Back
- Finished Back

NOTE: Top and base are required.

For ordering options, see back of Jefferson Identification card at the beginning of section.

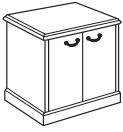
Item	Model No.	W	D	H	K	R	Ship Wt	Cubic Ft	List Price
SINGLE CABINET UNIT	46-1	30 1/2	20	30	-	-	128	14.0	C1 \$ 2069
									C2 \$ 2114



Consists of:	Qty		
46-2031TP	1	• Top	C1 \$ 400 C2 \$ 445
46-1829MS	1	• Modular Storage Cabinet	\$ 1348
46-2031BS	1	• Base	\$ 321

VERTICAL STORAGE UNIT	46-4	88 1/2	20	83	-	-	721	88.6	C1 \$ 11756
									C2 \$ 11887



Consists of:	Qty		
46-1589FC	1	• Cornice Frame	\$ 699
46-2952BC	2	• Bookcases	\$ 2260
46-2952MB	1	• Mesh Door Bookcase	\$ 1972
46-2089TP	1	• Top	C1 \$ 1071
			C2 \$ 1202
46-1829MU	2	• Modular Box/Box/File Cabinets	\$ 3670
46-1829MS	1	• Modular Storage Cabinet	\$ 1348
46-2089BS	1	• Base	\$ 736

For ordering options, see back of Jefferson Identification card at the beginning of section.

Item	Model No.	W	D	H	K	R	Ship Wt	Cubic Ft	List Price
CREDENZA	46-10	88 1/2	20	30	-	-	426	41.1	C1 \$ 6825
									C2 \$ 6956

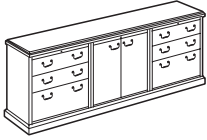
Consists of:
Qty

46-2089TP	1	• Top	C1 \$ 1071
			C2 \$ 1202
46-1829MS	1	• Modular Storage Cabinet	\$ 1348
46-1829MU	2	• Modular Box/Box/File Cabinets	\$ 3670
46-2089BS	1	• Base	\$ 736

DOUBLE BOOKCASE	46-13	59 1/2	13	55 1/2	-	-	213	34.7	C1 \$ 3274
									C2 \$ 3341

Consists of:
Qty

46-1560TP	1	• Top	C1 \$ 642
			C2 \$ 709
46-2952BC	2	• Bookcases	\$ 2260
46-1560BS	1	• Base	\$ 372

For ordering options, see back of Jefferson Identification card at the beginning of section.

Item	Model No.	W	D	H	K	R	Ship Wt	Cubic Ft	List Price
WALL UNIT WITH GRILLE DOORS	46-17	88 1/2	20	83	29	-	547	62.8	C1 \$ 10026
									C2 \$ 10157



Consists of:	Qty		
46-1589FC	1	• Cornice Frame	\$ 699
46-2952MB	2	• Mesh Door Bookcase	\$ 3944
46-2089TP	1	• Top	C1 \$ 1071
			C2 \$ 1202
46-1829MF	2	• Modular File/File Cabinets	\$ 3670
46-2031BS	2	• Bases	\$ 642

EXECUTIVE "L" UNIT	46-20	72	81	30	27 3/4	-	480	71.8	C1 \$ 6534
									C2 \$ 6802

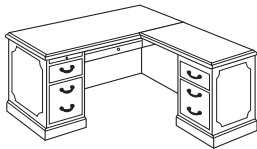

Consists of:	Qty		
46-3672LP	1	• Left Pedestal Desk	C1 \$ 3903
			C2 \$ 4092
46-2445RF	1	• Executive Right Return	C1 \$ 2631
			C2 \$ 2710

All pedestal desks shown as left.
 All returns shown as right.

For ordering options, see back of Jefferson Identification card at the beginning of section.

Item	Model No.	W	D	H	K	R	Ship Wt	Cubic Ft	List Price
EXECUTIVE "U" UNIT	46-21	72	106	30	-	-	658	84.5	C1 \$ 8258
									C2 \$ 8640

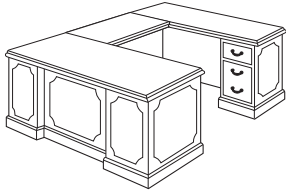

Consists of:	Qty		
46-3672LP	1	• Left Pedestal Desk	C1 \$ 3903 C2 \$ 4092
46-2450UF	1	• Bridge	C1 \$ 1364 C2 \$ 1452
46-2072RC	1	• Executive Single Right Credenza	C1 \$ 2991 C2 \$ 3096

EXECUTIVE "U" UNIT P-TOP	46-22	72	112	30	-	-	698	122.6	C1 \$ 12297
									C2 \$ 12791

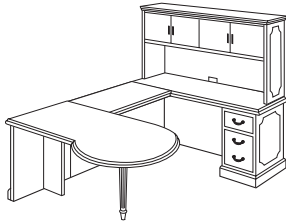

Consists of:	Qty		
46-4272PL	1	• Left Peninsula P-Top Unit	C1 \$ 3739 C2 \$ 3960
46-2450UF	1	• Bridge	C1 \$ 1364 C2 \$ 1452
46-2072RC	1	• Executive Right Credenza	C1 \$ 2991 C2 \$ 3096
46-1572HU	1	• Hutch	C1 \$ 4203 C2 \$ 4283

All pedestal desks shown as left.
 All returns shown as right.

For ordering options, see back of Jefferson Identification card at the beginning of section.

TACKBOARD: SURFACE MOUNTED HUTCHES – 20 1/8" TALL

Size	Model #	COM ydg	COM, Grade 1, 2 or 3 List Price	Grade 4 List Price	Grade 5 List Price	Grade 6 List Price	Grade 7 List Price	Grade 8 List Price	Grade 9 List Price	Grade 10 List Price
66"	TB-4666H	2.0	\$ 336	\$ 518	\$ 600	\$ 690	\$ 810	\$ 937	\$ 1090	\$ 1263
72"	TB-4672H	2.25	\$ 357	\$ 561	\$ 653	\$ 755	\$ 890	\$ 1033	\$ 1204	\$ 1399

TACKBOARD: WALL MOUNTED HUTCHES – 21 7/8" TALL

Size	Model #	COM ydg	COM, Grade 1, 2 or 3 List Price	Grade 4 List Price	Grade 5 List Price	Grade 6 List Price	Grade 7 List Price	Grade 8 List Price	Grade 9 List Price	Grade 10 List Price
36"	TB-0136W	1.25	\$ 274	\$ 387	\$ 438	\$ 495	\$ 570	\$ 649	\$ 744	\$ 853

TASKLIGHTS - Includes 1 Wire Management Grommet

Model #	Size	Description	List Price
TL-0824	22 1/2" x 1 5/8" x 7/8"	84-LED, 7 Watts	\$ 234
TL-0848	47 1/2" x 1 5/8" x 7/8"	240-LED, 18 Watts	\$ 280

Wilmington™

Casegoods Collection

How to Order

MODEL NO.	DESCRIPTION
36-3672DP	Finish MW Top Surface W

All options must be labeled and specified.



Specifications



veneer

Veneers on exposed surfaces are select grade sliced American Black Walnut and are carefully selected and matched to assure proper balance and consistency.

tops

Wood veneer and high pressure laminate tops are 3-ply balanced construction, 1 $\frac{1}{16}$ " thick with solid hardwood rims. Veneer tops have mitered corners and laminate tops have butt corners. Grain direction runs left to right unless otherwise noted.

chassis construction

Pedestals are of mortised and tenoned construction with all joints securely fastened with screws, hardwood screw rail brackets, and metal brackets. Solid hardwood parting rails assure a sturdy pedestal. Bases are solid hardwood with mitered corners. All units have finished veneer backs. Superior construction offers tight tolerances and long-term durability. All units equipped with heavy-duty, adjustable glides to ensure proper leveling and compensate for uneven floors.

drawers

All drawer fronts are standard with elegant walnut bookmatched veneer faces. Fronts are 3-ply construction and $\frac{3}{4}$ " thick. Drawer interiors are constructed with $\frac{7}{16}$ " hardwood sides and backs and $\frac{5}{32}$ " thick hardboard bottoms. Lateral files have $\frac{1}{4}$ " thick drawer bottoms for storage applications. The drawer interiors are sanded, sealed, and finished to provide a smooth, quality feel and appearance.

drawer suspension

File drawers have high quality, progressive full extension slides with precision ball bearings to ensure a smooth, quiet operation. Tray and box drawers are equipped with $\frac{3}{4}$ " extension ball bearing action slides with positive stop action. All suspensions have a lifetime warranty.

filing hardware

All file drawers are standard with custom fitted filing systems designed to accommodate a variety of filing requirements. Legal width file drawers provide legal filing front to back, and letter or legal filing side to side. Letter width file drawers provide letter filing front to back, and letter or legal filing side to side.

locking

Central locking is standard on all desks. One key in the lock cylinder locks all drawers in the desk. Removable lock cylinders allow for units to be re-keyed at a later date if required. Units are shipped randomly keyed as standard.

cord management

Route power and data cables away from the worksurface through inherent grommet placement. Black grommets are standard in back panels of assembled returns, bridge units, kneespace credenzas, and hutch units. A grommet is standard in tops of corner units. Grommets may be ordered in the tops of desks, returns, bridge units, credenzas, and component work-surfaces. See page 456 for all optional grommet locations.

Undersurface tracks are available for additional cord management. Silver grommets are also available. See Accessories.

finish

The multi-step, finish process used by Indiana Furniture provides years of lasting beauty. High quality finish materials offer distinctive grain clarity, superior resistance to normal wear, and easy maintenance. Wood veneer tops are shipped standard with satin sheen finish unless order is specified with "high sheen tops." Optional Wilmington 3600 Series high sheen tops feature a full-filled rubbed mirror-like appearance. See page 456 for high sheen top option.

Traditional Excellence

Finish Options

WOOD VENEER (W) OR LAMINATE (P) TOPS - MUST SPECIFY



Legacy Walnut
LW



Harvest Walnut
HW



Mahogany on Walnut
MW

Available in High Pressure Laminate Tops. **(P)**

Edge



Wilmington
R

All tops are standard with a traditional edge detail.

Pull

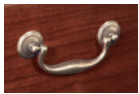

Wilmington
WLM

Wilmington units are standard with traditional pulls.

COORDINATING PRODUCTS

Wilmington Casegoods offers options to coordinate with Cameo Conference and Cameo Reception.

INTERIOR DRAWER DIMENSIONS

WILMINGTON 3600 INTERIOR DRAWER DIMENSIONS

Item	Drawers	W	L	D
36-3672DP	Tray	12 ³ / ₈	19 ⁹ / ₃₂	1 ²⁹ / ₃₂
36-3066DP	File	12 ³ / ₈	19 ⁹ / ₃₂	8 ²⁹ / ₃₂
	Box	12 ³ / ₈	19 ⁹ / ₃₂	3 ²¹ / ₃₂
	Center	29 ⁹ / ₁₆	19 ⁹ / ₃₂	1 ²⁹ / ₃₂
36-3672LP	Tray	12 ³ / ₈	19 ⁹ / ₃₂	1 ²⁹ / ₃₂
36-3672RP	File	12 ³ / ₈	19 ⁹ / ₃₂	8 ²⁹ / ₃₂
	Box	12 ³ / ₈	19 ⁹ / ₃₂	3 ²¹ / ₃₂
	Center	27 ⁵ / ₈	19 ⁹ / ₃₂	1 ²⁹ / ₃₂
36-3066LP	Tray	12 ³ / ₈	19 ⁹ / ₃₂	1 ²⁹ / ₃₂
36-3066RP	File	12 ³ / ₈	19 ⁹ / ₃₂	8 ²⁹ / ₃₂
	Box	12 ³ / ₈	19 ⁹ / ₃₂	3 ²¹ / ₃₂
	Center	21 ⁵ / ₈	19 ⁹ / ₃₂	1 ²⁹ / ₃₂
36-2445LF	Tray	12 ³ / ₈	16 ⁷ / ₃₂	1 ²⁷ / ₃₂
36-2445RF	File	12 ³ / ₈	16 ⁷ / ₃₂	8 ²⁹ / ₃₂
	Box	12 ³ / ₈	16 ⁷ / ₃₂	3 ²¹ / ₃₂
	Center	21 ⁵ / ₈	16 ⁷ / ₃₂	1 ²⁹ / ₃₂
36-2072KC	Tray	15 ³ / ₈	16 ⁷ / ₃₂	1 ²⁷ / ₃₂
36-2072SC	File	15 ³ / ₈	16 ⁷ / ₃₂	8 ²⁹ / ₃₂
36-2072LC	Box	15 ³ / ₈	16 ⁷ / ₃₂	3 ²¹ / ₃₂
36-2072RC	Center	27 ⁵ / ₈	16 ⁷ / ₃₂	1 ²⁹ / ₃₂
36-2066KC	Tray	12 ³ / ₈	16 ⁷ / ₃₂	1 ²⁹ / ₃₂
36-2066SC	File	12 ³ / ₈	16 ⁷ / ₃₂	8 ²⁹ / ₃₂
36-2066LC	Box	12 ³ / ₈	16 ⁷ / ₃₂	3 ²¹ / ₃₂
36-2066RC	Center	21 ⁵ / ₈	16 ⁷ / ₃₂	1 ²⁹ / ₃₂
36-2036L2	File	30 ³ / ₄	16 ⁷ / ₃₂	8 ¹³ / ₃₂
36-2036L4	Center	60 ³ / ₄	16 ⁷ / ₃₂	1 ²⁹ / ₃₂
36-2072DL	Center	54 ³ / ₄	16 ⁷ / ₃₂	1 ²⁹ / ₃₂
36-2072LL	Center	108 ³ / ₄	16 ⁷ / ₃₂	1 ²⁹ / ₃₂
36-2072RL	Center	54 ³ / ₄	16 ⁷ / ₃₂	1 ²⁹ / ₃₂
36-3672TD	Tray	21 ⁵ / ₈	19 ⁹ / ₃₂	1 ²⁹ / ₃₂
36-3066TD	Center	42 ⁵ / ₈	19 ⁹ / ₃₂	1 ²⁹ / ₃₂

FILING CAPABILITIES

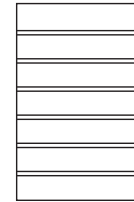
 12 ³/₈ x 19 ⁹/₃₂

Letter Front to Back

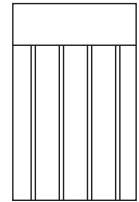

Legal Side to Side

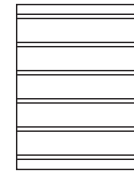
 12 ³/₈ x 16 ⁷/₃₂

Letter Front to Back

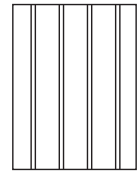

Legal Side to Side

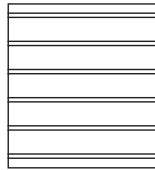
 15 ³/₈ x 16 ⁷/₃₂

Legal Front to Back

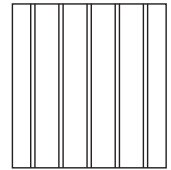

Legal Side to Side

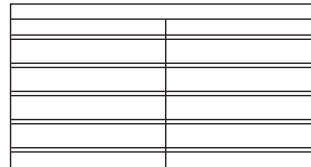
 30 ³/₄ x 16 ⁷/₃₂

2 Rows Letter Front to Back

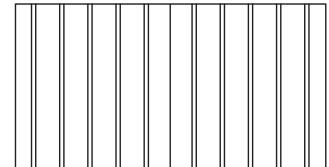

1 Row Legal Side to Side

GROMMET LOCATIONS

Add upcharge of \$48 list for each grommet.

Specify grommet locations.

- GL - Grommet Left
- GC - Grommet Center
- GR - Grommet Right

Example: 36-3672DP-GL (Grommet Left)

Grommets may be ordered in non-standard locations. Please call Customer Service to assist with how to order and additional lead time requirements.

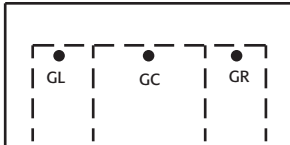

36-3672DP
 36-3672LP
 36-3672RP

GL/GR - 12" from ends, 23" from user side.
 GC - 23" from user side.

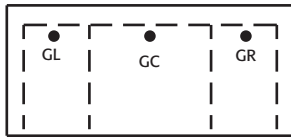

36-3066DP
 36-3066LP
 36-3066RP

GL/GR - 9" from ends, 23" from user side.
 GC - 23" from user side.

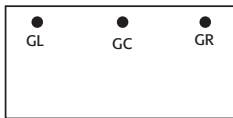

36-2450UF
 36-2450UFH
 36-2442UF
 36-2442UFH

GL/GR - 4" from ends, 19 1/2" from user side.
 GC - 19 1/2" from user side.

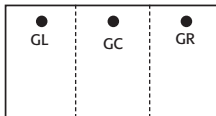

36-2445LF
 36-2445RF

GL/GR - 5" from ends, 20" from user side.
 GC - 20" from user side.

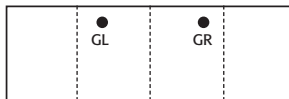

36-2072KC
 36-2072LC
 36-2072RC
 36-2072LL
 36-2072RL

GL/GR - 22 1/2" from ends, 17 3/8" from user side.

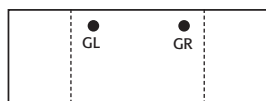

36-2066KC
 36-2066LC
 36-2066RC

GL/GR - 19 1/2" from ends, 17 3/8" from user side.

LOCKING FILE DRAWERS

Locking file drawers are available on returns and credenzas.

Returns and single pedestal credenzas have optional locking file drawers with the lock positioned in the upper right corner of the file drawer. Upcharge for return or single pedestal credenza locking file drawer is \$127 list.

Double pedestal credenzas have optional locking in both file drawers with the lock positioned in the upper right corner of both file drawers. Upcharge for locking double pedestal credenzas is \$252 list.

LOCKING HUTCH DOORS

Locking doors are available on hutches. Please specify with locking and add \$71 list to the following units.

36-1572HU 36-1572AH
 36-1566HU 36-1566AH

Please specify with locking and add \$58 list to the following units.

36-1536WD 36-1536AW

HIGH SHEEN WOOD VENEER TOPS

An open grain high sheen wood veneer top finish is available on Wilmington units.

"High Sheen Tops" must be specified on order.

Contact Customer Service for pricing and lead time.

Item	Model No.	W	D	H	K	R	Ship Wt	Cubic Ft	List Price
EXECUTIVE DOUBLE PED DESK	36-3672DP	72	36	30	31 1/2	10 1/2	297	52.2	P \$ 3222 W \$ 3473
	36-3066DP	66	30	30	31 1/2	4 1/2	260	40.2	P \$ 3181 W \$ 3387

Description

- Central Locking
- Letter Width Pedestals
- Tray/File/Box Pedestals
- Pull Out Writing Shelves
- Chassis 64W x 24D

EXECUTIVE SINGLE PED DESK	Left Ped	Right Ped	W	D	H	K	R	Ship Wt	Cubic Ft	List Price
EXECUTIVE SINGLE PED DESK	36-3672LP	36-3672RP	72	36	30	30 3/4	11	207	52.2	P \$ 2774 W \$ 3027
	Chassis 69W x 24D									
EXECUTIVE SINGLE PED DESK	36-3066LP	36-3066RP	66	30	30	24 3/4	5	181	40.2	P \$ 2705 W \$ 2913
	Chassis 63W x 24D									

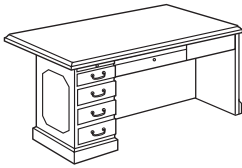
Description

- Central Locking
- Letter Width Pedestal
- Tray/File/Box in Pedestal
- Pull Out Writing Shelf

TABLE DESK	Model No.	W	D	H	K	R	Ship Wt	Cubic Ft	List Price
TABLE DESK	36-3672TD	72	36	30	64	-	120	12.2	P \$ 1889 W \$ 2140
	36-3066TD	66	30	30	58	-	110	9.7	P \$ 1666 W \$ 1874

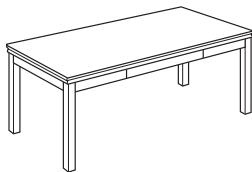

Description

- Center Drawer
- Top and Legs Ship Separately

Options: Specify & Add

36-0202TL	Standard Straight Legs	20	.9	Included
36-0202QL	Optional Queen Anne Legs	20	3.1	\$ 1469

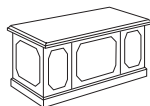
All pedestal desks shown as left.



Approach View

For ordering options, see back of Wilmington Identification card at the beginning of section.

For grommet options, see page 456.

Item	Model No.	W	D	H	K	R	Ship Wt	Cubic Ft	List Price
EXECUTIVE RETURN TRAY/FILE/BOX	Left Ped								
	Right Ped								
	36-2445LF	45	24	30	26 1/4	-	145	21.8	P \$ 2012 W \$ 2170

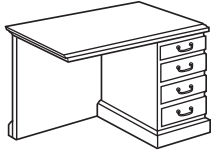
Description

- Letter Width Pedestal
- Tray/File/Box in Pedestal
- Grommet in Back Panel
- Grain Direction Runs Front to Back on Worksurface

EXECUTIVE BRIDGE FULL MODESTY	36-2450UF	50	24	30	48 7/8	-	75	6.5	P \$ 1115 W \$ 1283
	36-2442UF	42	24	30	40 7/8	-	65	5.5	P \$ 1068 W \$ 1232

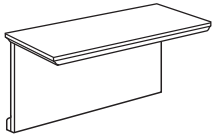
Description

- Grommet in Back Panel
- Grain Direction Runs Front to Back on Worksurface
- Hinged Back Panel

NOTE: Keyboards can not be factory installed.

EXECUTIVE BRIDGE HALF MODESTY	36-2450UFH	50	24	11 1/16	48 7/8	-	54	6.5	P \$ 1007 W \$ 1174
	36-2442UFH	42	24	11 1/16	40 7/8	-	43	5.5	P \$ 959 W \$ 1124

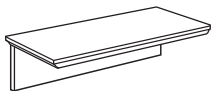
Description

- Grain Direction Runs Front to Back on Worksurface
- Hinged Back Panel

NOTE: Keyboards can not be factory installed.

All returns shown as right.

For ordering options, see back of Wilmington Identification card at the beginning of section.

For grommet options, see page 456.

Item	Model No.	W	D	H	K	R	Ship Wt	Cubic Ft	List Price
CORNER UNIT	36-4242CU	42	42	30	25 7/16	-	145	34.5	P \$ 1551 W \$ 2012
	36-3636CU	36	36	30	17	-	135	25.7	P \$ 1433 W \$ 1895

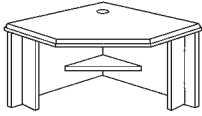
Description

- Freestanding Support Unit
- Connects to 24" Deep Bridge and Return Units
- Grommet in Top
- Grain Direction on Wood Veneer Worksurface Runs Front to Back

NOTE: Not all keyboards will fit the 36-3636CU. Recommended keyboards are 1-KCWR, 1-KCPR, and 1-KC.

EXECUTIVE CREENZA TRAY/FILE/BOX	Left Ped	Right Ped	W	D	H	K	R	Ship Wt	Cubic Ft	List Price
		36-2072LC Legal Pedestal	36-2072RC	72	20 7/16	30	27 11/16	-	145	29.2
	36-2066LC Letter Pedestal	36-2066RC	66	20 7/16	30	24 11/16	-	132	26.6	P \$ 2184 W \$ 2406

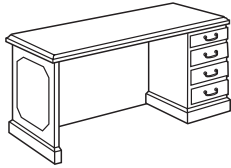
Description

- Letter Width Pedestal
- Tray/File/Box in Pedestal
- Grommet in Back Panel
- Profiled on 3 Sides for Flush Wall Application

EXECUTIVE CREENZA LATERAL FILE	Left Ped	Right Ped	W	D	H	K	R	Ship Wt	Cubic Ft	List Price
		36-2072LL	36-2072RL	72	20 7/16	30	12 5/16	-	160	29.0

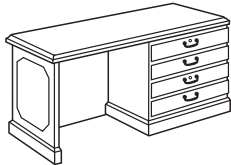
Description

- Locking File
- Legal or Letter Filing
- Grommet in Back Panel
- Profiled on 3 Sides for Flush Wall Application

All credenzas shown as right.

For ordering options, see back of Wilmington Identification card at the beginning of section.

For grommet options, see page 456.

Item	Model No.	W	D	H	K	R	Ship Wt	Cubic Ft	List Price
TRANSACTION RISER FOR DESKS/CREDENZAS	36-1272TR	72	12	13 1/16	-	-	54	9.7	P \$ 1449
	For Use with 72" Worksurfaces								W \$ 1535
	36-1266TR	66	12	13 1/16	-	-	51	9.6	P \$ 1299
	For Use with 66" Worksurfaces								W \$ 1383

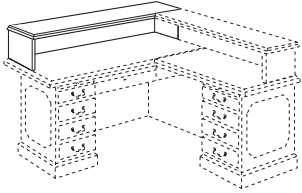
Description

- Freestanding Riser for Desks or Credenzas
- May Be Used in Conjunction with Return Risers or Bridge Risers

**TRANSACTION RISER
FOR RETURNS**

	Left Ped	Right Ped	W	D	H	K	R	Ship Wt	Cubic Ft	List Price
	36-0969LU	36-0969RU	69	9	13 1/16	-	-	43	7.6	P \$ 1392
	For Use with 36" Desks and 45" Returns									W \$ 1469
	36-0963LU	36-0963RU	63	9	13 1/16	-	-	41	7.6	P \$ 1247
	For Use with 30" Desks and 45" Returns									W \$ 1325

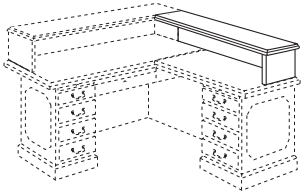
Description

- Must Be Used in Conjunction with a Desk Riser
- Grain Direction Runs Left to Right on Worksurface if Laminate Top is Specified

**TRANSACTION RISER
FOR BRIDGES**

	36-0981BU	82 3/8	9	13 1/16	-	-	48	8.2	P \$ 1341
	For Use with 36" Desk and 50" Bridge								W \$ 1419
	36-0968BU	68 3/8	9	13 1/16	-	-	43	6.8	P \$ 1203
	For Use with 30" Desk and 42" Bridge								W \$ 1283

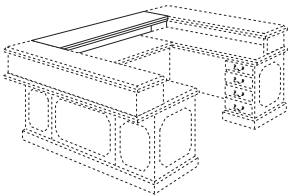
Description

- Must Be Used in Conjunction with Two Desks/Credenza Risers
- Grain Direction Runs Left to Right on Worksurface if Laminate Top is Specified

For ordering options, see back of Wilmington Identification card at the beginning of section.

Item	Model No.	W	D	H	K	R	Ship Wt	Cubic Ft	List Price
STORAGE CREENZA	36-2072SC	72	20 7/16	30	-	-	228	30.7	P \$ 3107
	Legal Width Ped								W \$ 3329
	36-2066SC	66	20 7/16	30	-	-	215	26.6	P \$ 2935
	Letter Width Ped								W \$ 3158

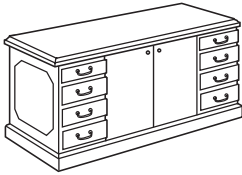
Description

- Tray/File/Box in Both Pedestals
- Fixed Storage Shelf Behind Doors
- Profiled on 3 Sides for Flush Wall Application

Item	Model No.	W	D	H	K	R	Ship Wt	Cubic Ft	List Price
KNEESPACE CREENZA	36-2072KC	72	20 7/16	30	31 1/2	-	165	30.7	P \$ 2789
	Legal Width Ped								W \$ 3011
	36-2066KC	66	20 7/16	30	31 1/2	-	150	26.6	P \$ 2647
	Letter Width Ped								W \$ 2870

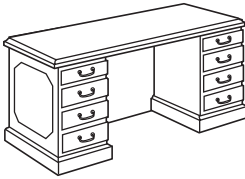

Description

- Tray/File/Box in Both Pedestals
- Grommet in Back Panel
- Profiled on 3 Sides for Flush Wall Application

For ordering options, see back of Wilmington Identification card at the beginning of section.

For grommet options, see page 456.

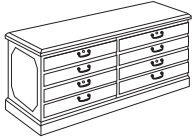
Item	Model No.	W	D	H	K	R	Ship Wt	Cubic Ft	List Price
DOUBLE LATERAL FILE CREENZA	36-2072DL	72	20 ⁷ / ₁₆	30	-	-	260	31.9	P \$ 3856 W \$ 4079

Description

- Legal or Letter Filing Side to Side or Front to Back
- Independent Locking System on Each Drawer

FOUR DRAWER LATERAL FILE	36-2036L4	36	20 ⁷ / ₁₆	52 ⁷ / ₈	-	-	211	27.8	P \$ 3496 W \$ 3619
-----------------------------	-----------	----	---------------------------------	--------------------------------	---	---	-----	------	------------------------

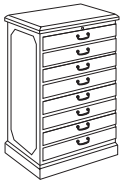
Description

- Central Locking System
- Anti-Tilt System
- Legal or Letter Filing Side to Side or Front to Back

TWO DRAWER LATERAL FILE	36-2036L2	36	20 ⁷ / ₁₆	30	-	-	135	14.9	P \$ 1968 W \$ 2092
----------------------------	-----------	----	---------------------------------	----	---	---	-----	------	------------------------

Description

- Independent Locking System on Each Drawer
- Legal or Letter Filing Side to Side or Front to Back
- Finished Back

For ordering options, see back of Wilmington Identification card at the beginning of section.

Item	Model No.	W	D	H	K	R	Ship Wt	Cubic Ft	List Price
WOOD DOOR SURFACE MOUNT HUTCH	36-1572HU	72	14	39 1/4	-	-	173	30.3	W \$ 2925
	36-1566HU	66	14	39 1/4	-	-	165	29.6	W \$ 2647

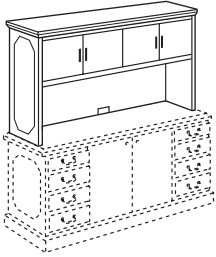
Description

- Storage Behind Wood Doors
- Grommet
- 21" Clearance Below Doors

ACRYLIC DOOR SURFACE MOUNT HUTCH	36-1572AH	72	14	39 1/4	-	-	173	30.3	W \$ 3167
	36-1566AH	66	14	39 1/4	-	-	165	29.6	W \$ 2887

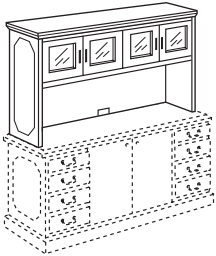
Description

- Storage Behind Acrylic Doors
- Grommet
- 21" Clearance Below Doors

Options: Specify & Add

CA	Clear Acrylic Door Inserts	Included
FA	Frosted Acrylic Door Inserts	Included

For ordering options, see back of Wilmington Identification card at the beginning of section.

Tackboards and tasklights sold on page 469.

Item	Model No.	W	D	H	K	R	Ship Wt	Cubic Ft	List Price
WOOD DOOR WALL MOUNT HUTCH	36-1536WD	36	15	18 1/16	-	-	55	5.9	W \$ 1565

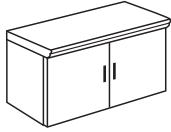
Description

- Mounts to Wall with Mounting Brace Included
- Storage Behind Wood Doors
- Profiled on Front Edge Only for Multiple Unit Application

NOTE: Indiana Furniture will not be held liable for wall mount hutches that are not properly installed.
 NOTE: This unit may not align suitably when configured with other 3600 units due to the traditional overhang tops on those products.

ACRYLIC DOOR WALL MOUNT HUTCH	36-1536AW	36	15	18 1/16	-	-	55	5.9	W \$ 1732
----------------------------------	-----------	----	----	---------	---	---	----	-----	-----------

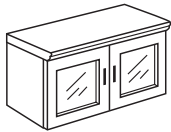
Description

- Mounts to Wall with Mounting Brace Included
- Storage Behind Acrylic Doors
- Profiled on Front Edge Only for Multiple Unit Application

Options: Specify & Add

CA	Clear Acrylic Door Inserts	Included
FA	Frosted Acrylic Door Inserts	Included

NOTE: Indiana Furniture will not be held liable for wall mount hutches that are not properly installed.
 NOTE: This unit may not align suitably when configured with other 3600 units due to the traditional overhang tops on those products.

For ordering options, see back of Wilmington Identification card at the beginning of section.
 Tackboards sold on page 469.

Item	Model No.	W	D	H	K	R	Ship Wt	Cubic Ft	List Price
TOP UNIT BOOKCASE	36-1534TU	34	15 1/2	45 9/16	-	-	80	18.5	W \$ 1392

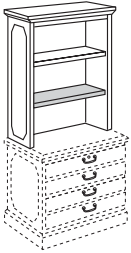
Description

- Fixed Bottom Shelf with 14" Clearance
- One Adjustable Shelf
- For Use on Two Drawer Lateral Files

BOOKCASES	36-3470BC	34	15 1/2	68 9/16	-	-	139	26.1	W \$ 1961
	Three Adjustable Shelves - One Fixed Shelf								
BOOKCASES	36-3448BC	34	15 1/2	47 13/16	-	-	100	18.8	P \$ 1203
	Two Adjustable Shelves								

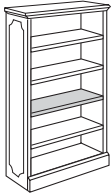
Description

- Open Storage
- Adjustable Shelves

DOUBLE WARDROBE/STORAGE	36-3670WD	36	20	68 9/16	-	-	310	34.2	W \$ 3685
----------------------------	-----------	----	----	---------	---	---	-----	------	-----------

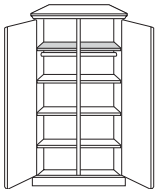
Description

- Fixed Top Shelf Behind Each Door
- Coat Rod Under Fixed Shelf
- Three Adjustable Shelves Behind Each Door

For ordering options, see back of Wilmington Identification card at the beginning of section.

Item	Model No.	W	D	H	K	R	Ship Wt	Cubic Ft	List Price
COMPUTER WORK TABLE	36-2445CW	45	24	26 5/16	41 7/16	-	102	19.9	P \$ 1672 W \$ 1833
	36-2436CW	36	24	26 5/16	32 7/16	-	82	17.6	P \$ 1631 W \$ 1788

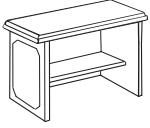

Description

- Fixed Shelf with 15 15/16" Clearance
- Grommet in Back Panel
- Grain Direction Runs Front to Back on Worksurface

Options: Specify & Add

CS-36BL	Optional Black Casters	\$ 150
---------	------------------------	--------

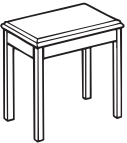
END TABLE	36-1824ET	24	18	21 13/16	-	-	25	2.5	P \$ 663 W \$ 772
-----------	-----------	----	----	----------	---	---	----	-----	----------------------

Description

- Shipped KD

LAMP TABLE	36-2828LT	28	28	21 13/16	-	-	37	3.1	P \$ 772 W \$ 827
------------	-----------	----	----	----------	---	---	----	-----	----------------------

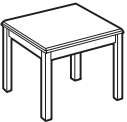
Description

- Shipped KD

For ordering options, see back of Wilmington Identification card at the beginning of section.

Item	Model No.	W	D	H	K	R	Ship Wt	Cubic Ft	List Price
MAGAZINE TABLE	36-1847MT	47	18	15 13/16	-	-	38	3.6	P \$ 809 W \$ 944

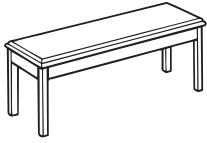
Description

- Shipped KD

Options: Specify & Add

SH-36	Optional 30" H Legs						20	.9	\$ 158
-------	---------------------	--	--	--	--	--	----	----	--------

Item	Model No.	W	D	H	K	R	Ship Wt	Cubic Ft	List Price	
CIRCULAR TABLE	36-4848CT	48	48	30	-	-	65	16.3	W \$ 2409	
	Accommodates 5 Chairs									
	36-4242CT	42	42	30	-	-	47	15.0	W \$ 1824	
Accommodates 4 Chairs										
	36-3636CT	36	36	30	-	-	37	14.0	W \$ 1647	
Accommodates 3-4 Chairs										



SIN 711-11

Description

- Hardwood Base
- Top and Base Sold Separately

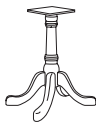

Options: Specify & Add

01-0606QB	Queen Anne Base						26	10.8	W \$ 879
-----------	-----------------	--	--	--	--	--	----	------	----------

NOTE: For laminate top options see Arlington.

For ordering options, see back of Wilmington Identification card at the beginning of section.

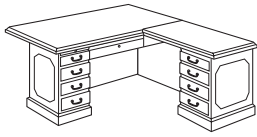
Item	Model No.	W	D	H	K	R	Ship Wt	Cubic Ft	List Price
EXECUTIVE "L" UNIT	36-1	72	81	30	30 3/4	-	352	74.0	P \$ 4786 W \$ 5197

Consists of:
Qty

36-3672LP	1	• Left Pedestal Desk	P \$ 2774 W \$ 3027
36-2445RF	1	• Executive Right Return	P \$ 2012 W \$ 2170

EXECUTIVE "U" UNIT	36-2	72	106	30	30 3/4	-	600	118.2	P \$ 9228 W \$ 9871
--------------------	------	----	-----	----	--------	---	-----	-------	------------------------

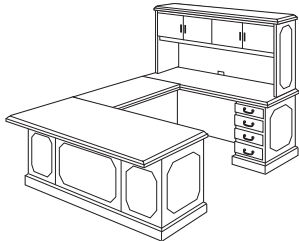
Consists of:
Qty

36-3672LP	1	• Left Pedestal Desk	P \$ 2774 W \$ 3027
36-2450UF	1	• Bridge	P \$ 1115 W \$ 1283
36-2072RC	1	• Executive Single Right Credenza	P \$ 2414 W \$ 2636
36-1572HU	1	• Hutch	W \$ 2925

All pedestal desks shown as left.
 All returns shown as right.

For ordering options, see back of Wilmington Identification card at the beginning of section.
 For standard options, see page 456.

TACKBOARD: SURFACE MOUNTED HUTCHES – 20 1/8" TALL

Size	Model #	COM ydg	COM, Grade 1, 2 or 3 List Price	Grade 4 List Price	Grade 5 List Price	Grade 6 List Price	Grade 7 List Price	Grade 8 List Price	Grade 9 List Price	Grade 10 List Price
66"	TB-3666H	2.0	\$ 336	\$ 518	\$ 600	\$ 690	\$ 810	\$ 937	\$ 1090	\$ 1263
72"	TB-3672H	2.25	\$ 357	\$ 561	\$ 653	\$ 755	\$ 890	\$ 1033	\$ 1204	\$ 1399

TACKBOARD: WALL MOUNTED HUTCHES – 21 7/8" TALL

Size	Model #	COM ydg	COM, Grade 1, 2 or 3 List Price	Grade 4 List Price	Grade 5 List Price	Grade 6 List Price	Grade 7 List Price	Grade 8 List Price	Grade 9 List Price	Grade 10 List Price
36"	TB-0136W	1.25	\$ 274	\$ 387	\$ 438	\$ 495	\$ 570	\$ 649	\$ 744	\$ 853

TASKLIGHTS – Includes 1 Wire Management Grommet

Model #	Size	Description	List Price
TL-0824	22 1/2" x 1 5/8" x 7/8"	84-LED, 7 Watts	\$ 234
TL-0848	47 1/2" x 1 5/8" x 7/8"	240-LED, 18 Watts	\$ 280

Accessories

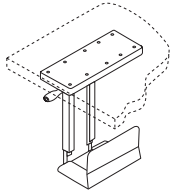

Item	Model No.	W	D	H	K	R	Ship Wt	Cubic Ft	List Price
CPU HOLDER	01-CPUMINIA	-	-	-	-	-	16	.4	\$ 240
	Aluminum								

Description

- Vertically Mounts to Undersurface
- 360° Swivel
- No Tools Required for Adjustment
- 13.4" Ball Bearing Glide Track
- 3.25" - 6" Adjustable Width
- 16" - 23" Adjustable Height
- 55 lb Load Capacity
- Fits CPU's 5" to 20" in Overall Height

DUAL ARTICULATING MONITOR ARM	01-MLEDGE2A	-	-	-	-	-	15	1.4	\$ 814
	Aluminum								
	01-MLEDGE2B	-	-	-	-	-	15	1.4	\$ 814
	Black								

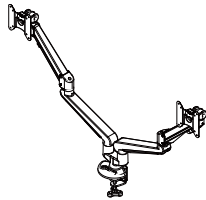

Description

- Dual Mount with Independent Adjustment
- 180° Lockout Feature
- 6.5" to 19.5" Height Adjustment
- 21" Monitor Extension
- 3.5" Monitor Retraction
- +30/-25° Monitor Tilt
- 17.6 lb Weight Capacity per Arm
- Enclosed Cable Management
- VESA 75mm and VESA 100 mm Compatible with Quick Monitor Release
- 360° Swivel at Two Points
- Includes Desk Clamp and Grommet Mount

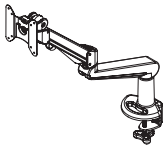
SINGLE MONITOR ARM	01-MLEDGE1A	-	-	-	-	-	13	2.2	\$ 480
	Aluminum								
	01-MLEDGE1B	-	-	-	-	-	13	2.2	\$ 480
	Black								

Description

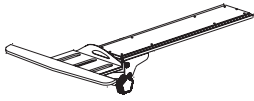
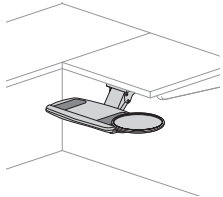
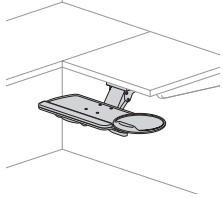
- 180° Lockout Feature
- 6.5" to 19.5" Height Adjustment
- 21" Monitor Extension
- 3.5" Monitor Retraction
- +30/-25° Monitor Tilt
- 17.6 lb Weight Capacity
- Enclosed Cable Management
- VESA 75mm and VESA 100 mm Compatible with Quick Monitor Release
- Includes Desk Clamp and Grommet Mount

Item	Model No.	W	D	H	Ship Wt	Cubic Ft	List Price
KEYBOARD MECHANISM WITH KEYBOARD CLAMP 	01-KCWR	18	7 1/4 -10 3/4	3	11	.5	\$ 369
Description <ul style="list-style-type: none"> • E2 Glide Slide System • Spring Assisted Height Adjustment • Knob Control • 360° Swivel • 30° Tray Tilt • Adjustable Keyboard Clamp • 18" Allante Wrist Rest • Track Measures 18" 							
Options: Specify & Add							
Factory Installed							\$ 130
KEYBOARD MECHANISM WITH KEYBOARD PLATFORM AND PALM REST 	01-KPMT	23 9/16	10 7/16	3	14	.8	\$ 576
Description <ul style="list-style-type: none"> • E2 Glide Slide System • Spring Assisted Height Adjustment • One Touch Control • 360° Arm Rotation • 30° Tray Tilt • 18" Gel Wrist Rest • Left or Right Handed Mouse Tray • Requires a Minimum of 31 1/2" of Kneespace When Mouse is Fully Extended • Track Measures 18" 							
Options: Specify & Add							
Factory Installed							\$ 130
KEYBOARD MECHANISM WITH KEYBOARD PLATFORM AND MOUSE TRAY AND PALM REST 	01-KPMP	26 1/2	10 7/16	3	14.3	1.0	\$ 699
Description <ul style="list-style-type: none"> • E2 Glide Slide System • Spring Assisted Height Adjustment • One Touch Control • 360° Arm Rotation • 30° Tray Tilt • Mouse Tray has Independent Tilt Swivel • 18" Gel Wrist Platform/Mouse Tray • Left or Right Handed Mouse Tray • Requires a Minimum of 30" of Kneespace When Mouse is Fully Extended • Track Measures 18" 							
Options: Specify & Add							
Factory Installed							\$ 130

Item	Model No.	W	D	H	Ship Wt	Cubic Ft	List Price
KEYBOARD MECHANISM WITH KEYBOARD CLAMP	01-KC	9	17	6	13	1.0	\$ 491

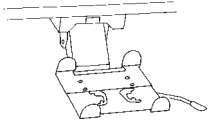

Description

- Ball Bearing Slides In and Out
- Spring Assisted Height Adjustment
- Lock Lever
- 360° Arm Rotation
- 25° Tray Tilt
- Adjustable Keyboard Clamp
- Track Measures 17"

Options: Specify & Add

Factory Installed	\$ 130
-------------------	--------

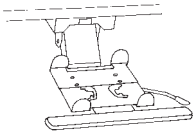
KEYBOARD MECHANISM WITH KEYBOARD CLAMP AND PALM REST	01-KCPR	9	17	6	14	1.0	\$ 657
--	---------	---	----	---	----	-----	--------



Description

- Ball Bearing Slides In and Out
- Spring Assisted Height Adjustment
- Lock Lever
- 360° Arm Rotation
- 25° Tray Tilt
- Adjustable Keyboard Clamp
- Palm Rest
- Track Measures 17"

Options: Specify & Add

Factory Installed	\$ 130
-------------------	--------

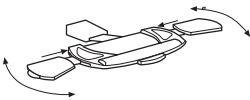
KEYBOARD MECHANISM WITH KEYBOARD PLATFORM AND MOUSE TRAY AND PALM REST	01-KPPR	23	17 1/2	6	16	2.0	\$ 627
--	---------	----	--------	---	----	-----	--------

Description

- Ball Bearing Slides In and Out
- Spring Assisted Height Adjustment
- Lock Lever
- 360° Arm Rotation
- 25° Tray Tilt
- Keyboard Platform
- Left or Right Handed Mouse Tray
- Palm Rest
- Requires a Minimum of 32" of Kneespace When Mouse is Fully Extended
- Track Measures 17"

Options: Specify & Add

Factory Installed	\$ 130
-------------------	--------

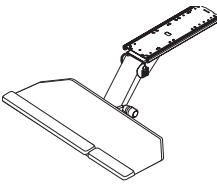
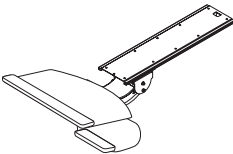
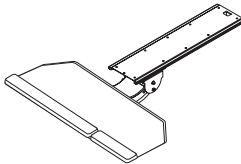
Item	Model No.	W	D	H	Ship Wt	Cubic Ft	List Price
ARTICULATING KEYBOARD CORNER PLATFORM 	01-KB90	25	10 1/2	3 1/2	19	1.4	\$ 748
Description							
<ul style="list-style-type: none"> • 25" Cut Corner Platform • Keyboard and Mouse on same level • Single Palm Rest for both Left & Right Hands • Lift & Lock Height Adjustment • +/- 15° Tilt Adjustment & 360 Rotation • Provides Additional Pivot Point • 8.42" Height Adjustment • Cannot Be Used on 20" Deep Unit • Not Available with Optional Center Grommet • Track Measures 21 3/4" 							
Options: Specify & Add							
Factory Installed							\$ 130
KEYBOARD MECHANISM WITH KEYBOARD PLATFORM AND MOUSE TRAY AND PALM REST 	01-KB3	26 1/2	14	4.5	16	1.4	\$ 578
Description							
<ul style="list-style-type: none"> • 18.75" Platform with Swivel-Below Mouse Platform • Palm Rest for Mousing Surface • Lift & Lock 7" Height Adjustment • +/- 15° Tilt Adjustment & 360 Rotation • Independent Tilt Adjustment • Cannot Be Used on 20" Deep Unit • Not Available with Optional Center Grommet • Track Measures 21" 							
Options: Specify & Add							
Factory Installed							\$ 130
ARTICULATING KEYBOARD CORNER PLATFORM 	01-KB2CC	25	10 1/2	4 1/2	16	1.4	\$ 517
Description							
<ul style="list-style-type: none"> • 25" Cut Corner Platform • Keyboard and Mouse on same level • Single Palm Rest for both Left & Right Hands • Works with 17"+ Diagonal Work Surface • +/- 15° Tilt Adjustment & 360 Rotation • Independent Tilt Adjustment • Lift & Lock 7" Height Adjustment • Cannot Be Used on 20" Deep Unit • Not Available with Optional Center Grommet • Track Measures 21" 							
Options: Specify & Add							
Factory Installed							\$ 130

Item	Model No.	W	D	H	Ship Wt	Cubic Ft	List Price
FLOOR LAMP	01-EQUO	32	10	44 ³ / ₄ - 56 ³ / ₄	8	2	\$ 602

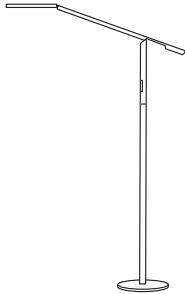

Open Market Only

Description

- 28 LED, 6 Watts
- Built-in Touchstrip Dimmer
- Multiple Dimming Levels
- 10' Power Cord
- CRI 85, 3500K Color Temperature

LED DESK LAMP	01-PIXIE	-	-	-	2.3	.1	\$ 233
---------------	----------	---	---	---	-----	----	--------

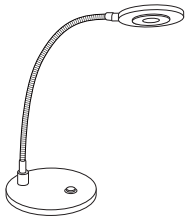

Open Market Only

Description

- Small Profile and Lightweight
- 11.8" Reach
- 7' Power Cord
- Energy Efficient 3 Watt LED Lamp
- CRI 70, 3300K Color Temperature

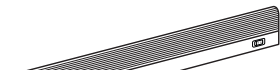
LED TASKLIGHTS	Model No.	W	D	H	Ship Wt	Cubic Ft	List Price
	TL-0848 84-LED, 7 Watts	47 ¹ / ₂	⁷ / ₈	1 ⁵ / ₈	-	-	\$ 280
	TL-0824 240-LED, 18 Watts	22 ¹ / ₂	⁷ / ₈	1 ⁵ / ₈	-	-	\$ 234

Description

- 6' Power Cord
- Rocker Style On/Off Switch

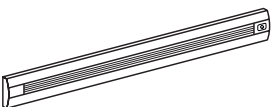
LED TASKLIGHT	Model No.	W	D	H	Ship Wt	Cubic Ft	List Price
	01-188LED58 188-LED, 43.5 Watts	57 ¹³ / ₃₂	¹ / ₂	2	-	-	\$ 1043
	01-94LED31 94-LED, 23.4 Watts	30 ¹ / ₈	¹ / ₂	2	-	-	\$ 755
	01-47LED17 47-LED, 10.9 Watts	16 ¹³ / ₃₂	¹ / ₂	2	-	-	\$ 436
	01-OSRP Occupancy Sensor	2 ⁵ / ₁₆	¹ / ₂	2	-	-	\$ 232

Description

- All LED Lights Include the Power Supply
- Occupancy Sensor Shuts Off After 30 Minutes of Inactivity and Turns on Immediately When Reentering the Detection Area

Item	Model No.	W	D	H	Ship Wt	Cubic Ft	List Price
ROUND GROMMET	01-GRMTSL	—	—	—	—	1	.1 \$ 23

 Open
 Market
 Only

Description

- 60mm Silver Round Grommet Cover
- Field Installed

RECTANGULAR GROMMET	01-HUGRMTSL	—	—	—	—	1	.1 \$ 23
---------------------	-------------	---	---	---	---	---	----------

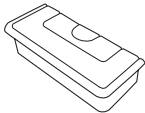
 Open
 Market
 Only

Description

- 70 x 30mm Silver Rectangular Grommet with Cover
- Field Installed

WORKSURFACE POWER CENTER	01-INTP	5¼	7	1¾	—	—	2	.2 \$ 491
--------------------------	---------	----	---	----	---	---	---	-----------

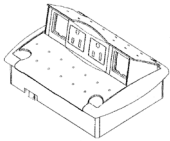

SIN 711-11

Description

- Two 15 Amp Duplex Outlets
- Two Voice/Data Ports
- Six Foot Cord
- Silver
- UL Listed

NOTE: To order voice/data modules for your specific requirements contact the local computer or telecommunications installation service in your area.

WORKSURFACE POWER CENTER	01-INTRFAC1A Aluminum	14¼	6¾	2⅞	—	—	11	.3 \$ 1306
	01-INTRFAC1B Black	14¼	6¾	2⅞	—	—	11	.3 \$ 1306

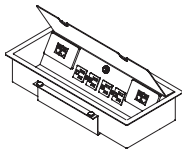



SIN 711-11

Description

- Four Power Receptacles in Two 15 Amp Duplexes
- One 15 Amp Circuit Breaker
- One Voice Port
- Three Data Ports
- Six Foot Cord
- UL Listed/CSA Certified
- Optional Telecom Plates, See Page 484

NOTE: To order voice/data modules for your specific requirements contact the local computer or telecommunications installation service in your area.

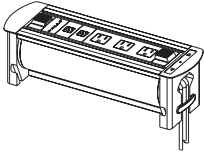
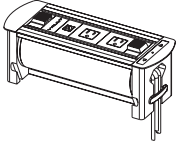
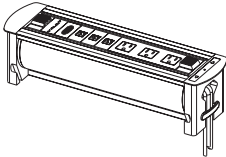
Data/Power/Communication Accessories

Item	Model No.	W	D	H	Ship Wt	Cubic Ft	List Price
TRAINING TABLE POWER & DATA VAULT  Open Market Only	01-TVAULTA	4 ½	13 ¾	4 ⅙	10	0.3	\$ 1030
Description <ul style="list-style-type: none"> • Electric Drive Motor Rotates the Surface Technology 180° to the Proper Position • Photo-Electronic Eye Prevents Rotation When Obstructed • 2 Data Ports and 3 Power Outlets • 6' Power Cord 							
HOTEL DESK POWER & DATA VAULT  Open Market Only	01-HVAULTA	4 ½	11 ¾	4 ⅙	10	0.3	\$ 991
Description <ul style="list-style-type: none"> • Electric Drive Motor Rotates the Surface Technology 180° to the Proper Position • Photo-Electronic Eye Prevents Rotation When Obstructed • 1 Data Ports and 2 Power Outlets • 6' Power Cord 							
CONFERENCE TABLE POWER & DATA VAULT  Open Market Only	01-CVAULTA	4 ½	15 ⅞	4 ⅙	10	0.4	\$ 1084
Description <ul style="list-style-type: none"> • Electric Drive Motor Rotates the Surface Technology 180° to the Proper Position • Photo-Electronic Eye Prevents Rotation When Obstructed • 3 Data Ports, 3 Power Outlets, and 1 VGA Port • 6' Power Cord 							
REVEAL POWER & DATA 	01-ASSEMBLERA Aluminum	6 ⅝	13 ⅜	3	5	0.3	\$ 612
	01-ASSEMBLERB Black	6 ⅝	13 ⅜	3	5	0.3	\$ 612
Description <ul style="list-style-type: none"> • Mounts Under Worksurface on Sturdy Ball Bearing Track • 1 Open Port, 1 USB, and 2 Power Outlets • Includes Voice/Data Adapter Kit to Accept Couplers and Jacks When Required • Does Not Require Cut Out in Worksurface • UL Listed 							

Data/Power/Communication Accessories

Item	Model No.	W	D	H	Ship Wt	Cubic Ft	List Price
OASIS MINI POWER & DATA	01-OASISMA Aluminum	15	9	4 1 ⁵ / ₁₆	7	.7	\$ 2018
	01-OASISMB Black	15	9	4 1 ⁵ / ₁₆	7	.7	\$ 2018
INTERACT POWER & DATA	01-INTERACTA Aluminum	9	5 3 ⁸ / ₁₆	2 3 ⁴ / ₁₆	5	.2	\$ 414
	01-INTERACTB Black	9	5 3 ⁸ / ₁₆	2 3 ⁴ / ₁₆	5	.2	\$ 414
DATA PORT 4	01-DPORT4A Aluminum	8	4	—	7	.2	\$ 690
	01-DPORT4B Black	8	4	—	7	.2	\$ 690
POWER 440	01-DATA440A Aluminum	5 5 ¹ / ₁₆	4 3 ⁸ / ₁₆	—	5	.2	\$ 610
	01-DATA440B Black	5 5 ¹ / ₁₆	4 3 ⁸ / ₁₆	—	5	.2	\$ 610

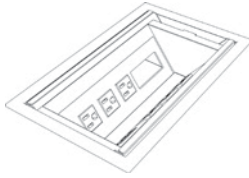
Description

- 2 Data/1 Voice Telecom Plates included
- Opening for 1 Additional Plate Sold Separately
- 4 Power Outlets
- Soft Touch Hinged Lid
- 9' Power Cord
- UL Listed
- Optional Telecom Plates, See Page 484

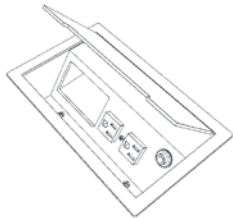
Description

- 1 Data/1 Voice Telecom Plate Included
- 2 Power Outlets
- Convenience Plug on Bottom
- 6' Power Cord
- UL Listed and CSA Certified
- Optional Telecom Plates, See Page 484

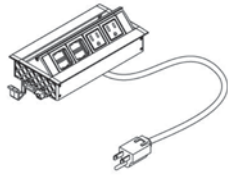

SIN 711-2

Description

- Retracts into Work Surface to Regain Productive Space
- One-Touch Access to Power and Data
- Two Power Outlets and Two Open Ports for Data
- Water-Proof Simplex (Outlets)
- Includes a Voice/Data Adapter Kit to Accept Couplers and Jacks When Required
- 6' Power Cord

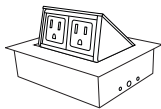

Description

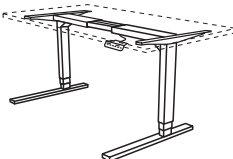
- 2 Power Outlets
- Soft Touch Hinged Lid
- 6' Power Cord

Item	Model No.	W	D	H	Ship Wt	Cubic Ft	List Price	
PNEUMATIC TABLE LIFT 	Silver	Black						
	01-2240PLS	01-2240PLB	36	22	26 - 45 1/2	66	2.3	\$ 3139
	Compatible with 24" Deep Tops that are 48" Long							
	01-2248PLS	01-2248PLB	44	22	26 - 45 1/2	68	2.3	\$ 3159
	Compatible with 24" Deep Tops that are 54" Long							
	01-2256PLS	01-2256PLB	52	22	26 - 45 1/2	70	2.5	\$ 3178
	Compatible with 24" Deep Tops that are 60" or 66" Long							
	01-2264PLS	01-2264PLB	60	22	26 - 45 1/2	71	2.8	\$ 3196
	Compatible with 24" Deep Tops that are 72" Long							
	01-2640PLS	01-2640PLB	36	22	26 - 45 1/2	66	2.3	\$ 3164
Compatible with 30" and 36" Deep Tops that are 48" Long								
01-2648PLS	01-2648PLB	44	22	26 - 45 1/2	68	2.3	\$ 3182	
Compatible with 30" and 36" Deep Tops that are 54" Long								
01-2656PLS	01-2656PLB	52	22	26 - 45 1/2	70	2.5	\$ 3200	
Compatible with 30" and 36" Deep Tops that are 60" or 66" Long								
01-2664PLS	01-2664PLB	60	22	26 - 45 1/2	71	2.8	\$ 3221	
Compatible with 30" and 36" Deep Tops that are 72" Long								

Description

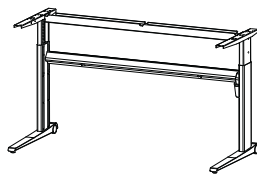
- Pneumatic Lift Operates with Ease
- Stop at Any Position
- Height Adjustment from 26" to 46 1/2"
- Adjustable Levelers
- Tops Sold Separately
- Some Assembly Required
- Optional Grommets Must Be Field Installed

ELECTRIC TABLE LIFT WITH CASTER

Open Market Only

Model No.	W	D	H	Ship Wt	Cubic Ft	List Price	
Silver	Black						
01-2861ELCS	01-2861ELCB	61 7/16	28 3/8	26 - 46 1/2	68	3	\$ 2010
Compatible with 30" and 36" Deep Tops that are 72" - 84" Long							

Description

- Height Adjusts from 26" to 46 1/2" at 1" per Second
- Flip Out Tray Stores Cables Under the Desk Top
- Built In Casters Provide Mobility if Desired
- 176 lbs Maximum Load
- Tops Sold Separately
- Some Assembly Required
- Optional Battery Pack Available
- Optional Grommets Must Be Field Installed

Item	Model No.	W	D	H	Ship Wt	Cubic Ft	List Price	
ELECTRIC TABLE LIFT  Open Market Only	Silver	Black						
	01-2232ELS	01-2232ELB	32 7/8	22 1/16	21 1/4 - 46 7/8	57	3.0	\$ 2074
	Compatible with 24" and 30" Deep Tops that are 42" - 48" Long							
	01-2256ELS	01-2256ELB	56 11/16	22 1/16	21 1/4 - 46 7/8	65	3.0	\$ 2139
Compatible with 24" and 30" Deep Tops that are 60" - 72" Long								
	01-2259ELS	01-2259ELB	59 13/16	22 1/16	21 1/4 - 46 7/8	66	3.0	\$ 2143
Compatible with 24" and 30" Deep Tops that are 72" - 84" Long								
Description								
<ul style="list-style-type: none"> • Height Adjusts from 21 1/4" to 46 7/8" at 1.2" per Second • 220 lbs Maximum Load • Automatic Safety Stop • Removable Top Bracket Allows Keyboard Installation • Tops Sold Separately • Some Assembly Required • Optional Battery Pack Available • Optional Grommets Must Be Field Installed 								
Options: Specify & Add								
01-ELCASTERS		• Locking						\$ 154
01-EXTENDERLEG		• Required For Cockpit and Extended Corner Tops						\$ 200

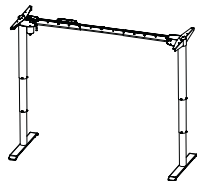
ELECTRIC TABLE LIFT  Open Market Only	Silver	Black					
	01-2445ELS	01-2445ELB	69 5/16 - 45 11/16	24	24 3/4 - 48 7/16	53	3.0
Compatible with 24" and 30" Deep Tops that are 60" - 84" Long							
Description							
<ul style="list-style-type: none"> • Width Adjusts from 45 11/16" to 69 5/16" in Intervals of 3 5/16" • Height Adjusts from 24 3/4" to 48 7/16" at 1.2" per Second • 220 lbs Maximum Load • Silver or Black with Inner Columns in Chrome • Tops Sold Separately • Some Assembly Required • Optional Battery Pack Available • Optional Grommets Must Be Field Installed 							

BATTERY PACK	01-BATTERYKIT	-	-	-	1	.5	\$ 879
---------------------	---------------	---	---	---	---	----	--------

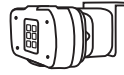
 Open Market Only	Description						
	<ul style="list-style-type: none"> • 24 Volt Battery with Charger • Works with Select Electric Table Lifts As Noted On Lift 						

Item	Model No.	W	D	H	Ship Wt	Cubic Ft	List Price
POWER STRIP	01-PRSP	9	2	2	1	-	\$ 128

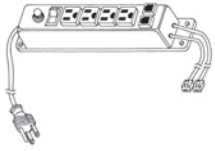
Description

- Four Outlets
- Two Phone Jacks
- Rocker Switch
- Black Plastic
- Suitable for Surface or Recessed Mounting
- 13 Amp Circuit Breaker
- 10 ft. Power Cord
- Two 14 ft. Phone Hook Up Cords
- UL Listed and CSA Certified

NOTE: Item will ship via UPS only.

WIRE MANAGERS	01-WMGR4	16	1 1/2	1	1	-	\$ 73
---------------	----------	----	-------	---	---	---	-------

Description

- Four Wire Manager Strips
- Black Plastic
- Snap Lock Channel
- Attaches with Adhesive Strips
- Can be Placed on All Units to Route Wires

NOTE: Item will ship via UPS only.

Compatible with 01-OASISMA, 01-OASISMB, 01-INTERACTA, 01-INTERACTB, 01-INTRFCIA, and 01-INTRFCIB.

Model No.	Description	List Price
01-ABL	Telecom Plate, Blank Plate	\$ 26
01-ABL737373	Telecom Plate, (3) RJ45 Cat 5e	\$ 233
01-ABLAB	Telecom Plate, (1) RJ45 Cat 6, (1) RJ11 Cat 3 Phone	\$ 129
01-ABLAB102	Telecom Plate, (1) RJ45 Cat 6, (1) RJ11 Cat 3, (1) USB W/72" Patch Cord	\$ 203
01-ABLABB	Telecom Plate, (2) RJ45 Cat 6, (1) RJ11 Cat 3 Phone	\$ 203
01-ABLB	Telecom Plate, (1) RJ45 Cat 6	\$ 95
01-ABLBB	Telecom Plate, (2) RJ45 Cat 6	\$ 164
01-ABLBBB	Telecom Plate, (3) RJ45 Cat 6	\$ 233
01-ABLBBBB	Telecom Plate, (4) RJ45 Cat 6	\$ 301
01-ABLBBC51	Telecom Plate, (2) RJ45 Cat 6, (1) 15 Pin HD VGA w/72" Patch Cord	\$ 282
01-ABLBC51L	Telecom Plate, (1) RJ45 Cat 6, (1) Mini Stereo Inline, (1) 15 Pin HD VGA w/72" Patch Cord	\$ 258
01-ABLC3811	Telecom Plate, (1) RJ45 Cat 6 Data Inline, (1) RJ11 Cat 3 Phone Inline	\$ 125
01-ABLC45	Telecom Plate, (1) HDMI w/36" Patch Cord	\$ 187
01-ABLC45C51L	Telecom Plate, (1) Mini Stereo Inline, (1) HDMI w/36" Patch Cord, (1) 15 Pin HD VGA w/72" Patch Cord	\$ 352
01-ABLC51L	Telecom Plate, (1) 15 Pin HD VGA & (1) Mini Stereo Inline Jack	\$ 189
01-ABLCRDM	Telecom Plate, (3) Cord Bushings	\$ 61

Indiana[®]
FURNITURE

1224 Mill Street
PO Box 270
Jasper, Indiana 47547-0270
Tel 812.482.5727
Tol 800.422.5727
Fax 812.482.9035
sales@indianafurniture.com

www.indianafurniture.com



Federal Classification: Small Business